

International Edition

Free,
electronic magazine
for railroad enthusiasts
in the scale 1:220
and Prototype

www.trainini.eu

Published monthly
no guarantee

ISSN 2512-8035

Trainini

German Magazine for Z Gauge



A Firecracker for Everyone

**Vimms 63 from ZetNa 220
First Steps for your Layout**

Introduction

Dear Readers,

We are still experiencing turbulent times: The longing for holidays in faraway countries is great, the infection situation at home is possibly relaxed, while countries, not too far away, are already being hit by a new wave.

Usually, our editions in midsummer are dominated by model railway themes that are intended to trigger a desire to travel and fit in well with the general wave of vacationers. Things are different this year, although our topics are no less exciting.

This choice of topics is not only because of the cadence of new releases. We have also deliberately chosen tinkering projects for the summer of 2021: This way, rainy days can be successfully spent in the cellar at the model railway layout.

However, it seems much more important to us not to suddenly become careless and negligent after one and a half years of austerity, to exchange virus variants across contacts of the most diverse regions and countries at large gatherings of people, and thus to prolong these miserable times even further.

How important, unique and worthy of protection our health is, we have had to experience at first hand, and this does not even require Covid-19. If several people in the private sphere have to spend almost the same time in hospital, visit doctors repeatedly, and often have to worry about their recovery, then this not only exhausts time and nerves for care, journeys and visits.

Above all, it clearly demonstrates that many things have no value without health and well-being. Here, too, we would like to set an example, an example of respect for the health of others.

Those who do not roam far, limit contacts and enjoy the most beautiful hobby in the world not only have fun, but also make a contribution to the community. And, that is exactly where this edition comes in.

With ZetNa 220 as the manufacturer, it is a little bit international, but with its livestock car VImms 63, it is still local to Germany. Märklin's push-pull (commuter) train fills a hurting gap in the programme and all together it will enhance the ride on the highly appreciated layout.

Building projects for experienced model railroaders and help for those new to the hobby ensure that the fire that burns within us when we build and tinker is not diminished. And for the evenings after a hopefully long and beautiful day of vacation, we have again found suitable reading.

In short: Actually, it's just like always! If everything feels familiar and routine, then we shouldn't really miss anything! In this sense, take care and stay healthy!

Sin-Z-erely,

Holger Späing



Holger Späing
Editor-in-chief

Editorial

Introduction 2

Model

Attention, Firecracker! 4
Only a short Heyday 12

Prototype

Currently no items

Design

Construction of the Ramps with Arcades 22

Technology

Curved Tracks on a good Foundation 37

Literature (not translated - only in German)

Portrait of a Celebrity 46
We wish you a good Journey! 48

News

Zetties and Trainini in Dialogue 51

Imprint 65

We thank Eisenbahnstiftung and Gerhard Tüllmann (Brilon) for historical photographs.

Date of publication of the German language version of this issue: 28 July 2020

Cover photo:

141 258-4 makes one of the numerous intermediate stops with its local train. At the beginning of the seventies, it leaves a well-maintained impression, which also applies to its cab control car, which cannot be seen in the picture, but which has only recently been converted to a Karlsruhe head.

The 141 series in green

Attention, Firecracker!

their wishes were to come true. In early summer 2021, the most important prototype version followed in chrome oxide green paint, which also gave the locomotive its nickname "firecracker." For us, this is reason enough to take another look at this conversion as well.

In the summer of 2019, Märklin announced a "train set for local traffic" (art. no. 81356). Behind this MHI product, which sounded so unspectacular, there was supposed to be a real firecracker: The class 141, the only missing unit locomotive from the first DB new construction programme, was thus within reach of all customers.

At the end of 2017, a steel-blue sister locomotive in its original design had been announced as a 2018 Insider Club model, and had been delivered just two months at the time of the announcement of the MHI special series.



The new Märklin local transport pack (art. no. 81356) is presented here in full length, which has some special features in store.

The chrome oxide green paint job as a "firecracker", which was to follow surprisingly quickly, is certainly very familiar to the majority of readers and remembered from their own experience. But those who rubbed their eyes in disbelief in April 2019 and asked why customers without club membership would also be able to enjoy this design, which we praise so much, and which grants a certain exclusivity for premium customers, so quickly, had to be taught better.

A full two years passed before this new product arrived at the dealers. So, it will not be until the summer of 2021 that we will be able to critically examine and appreciate the Silberling (Silver Coins) that accompany it, which have not yet been offered in this form, and the green all-round locomotive of days gone by.



The locomotive and its three carriages have their upsides and downsides, which will be discussed in detail below.

Because, it is so important for model railways and is to establish a whole series of new standards for Z gauge, this first form variant also deserves a more detailed report. And, so, in the following, we work out what makes the MHI train set so special, and also state what we don't like about it.

Undiscovered Silberling (Silver Coins) Versions

The three local coaches that are given to the locomotive to be discussed are printing variants that have not existed before in this design. This is particularly evident on the BDnrzf 740 cab control car with a Karlsruhe head. This design was procured from 1971 onwards for S-Bahn-like service.

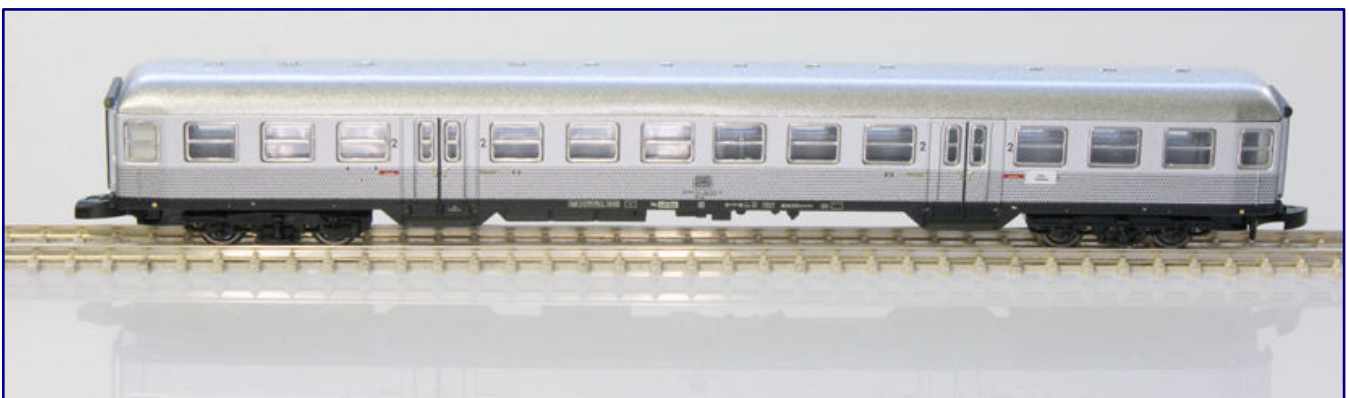

A black frame paint and the lettering typical for the beginning of the seventies look familiar. However, the Ege biscuit in negative design in the middle of the car is different from the Silberling of the first design.

For this reason, its front was also redesigned and later served as a template for converting the "Hasenkästen" (bunny boxes), which were unpopular with the prototype, to the same head shape.

The image of this driving trailer with two orange warning bars above and below the driver's cab front windows is familiar, before the appearance was to change with changing colour concepts. In the form now presented by Märklin, however, the model does not look familiar, at all.



Unchanged, the ABnrzb 704 has an incorrect roof, because the six cuckoo vents above the only five 1st class compartments belong to its sibling coach (photo above). The peacock eye pattern is not printed around the edges (photo below), which, fortunately, is hardly noticeable in the train set. The tail lights were also not designed in red.

It seems as if Märklin has forgotten the two stripe imprints. But this is far from being the case! The design of the first examples, that did not actually have the warning stripes, was reproduced here.

Whether it was more for aesthetic reasons or formal safety concerns that led to the later addition of the warning colour bars, we cannot answer with certainty. In any case, however, this model adds an interesting version to the existing programme.

It is lettered for Era IV, which also has a special value in combination with other features: The frame edge of the coach and its two siblings is black, which had not been offered in combination with Era IV inscriptions since the first appearance of the first Silberlings (construction period 1976/78 - 1983).

The supplementary print features also correctly include old class numbers (still) directly next to the entrance doors and written-out smoker and non-smoker signs in place of the later pictograms.

Rather standard on Märklin, but much rarer on the prototype according to our recollection, are the DB biscuits in negative design, i.e., the light and dark areas have been reversed in comparison to the fixed standard. This characterises all three coaches and is incidentally another difference to the original 8716 / 8717 / 8718 series.

What has not changed since 1978 (appearance of the cab control car) until today, and we do not like it is the lighting of the cab control car. Although it always had two red tail lights or three white head lights and an illuminated directional sign box depending on the direction of travel, its illumination was always poor.

This was due to the “flickering” incandescent lamps, which only provided a clearly visible emission at higher voltage. And Märklin actually managed to stick to this, although this technology has been outdated for more than twenty years and warm white LEDs have been the standard in Z gauge for well over ten years.



The Karlsruhe head of the driving trailer seems strange, but Märklin is right with this design: The first examples of these new control wagons did not have orange warning bars at the beginning.

At this point we can only shake our heads, because this shortcoming becomes all the more apparent in combination with the model of the ultra-modern class 141, because neither the motor nor the LEDs in the locomotive need a high voltage: the train runs at prototypical speed and the driving trailer remains virtually dark.

After the delivery of the train set was two years in coming and the “bunny box” with modern LED lighting was recently announced as a new design, hopes rose not only among us that this wagon could also benefit from it after all. Did some old stocks have to be reduced here?

The look at the other two wagons will be brief, as most of the features can be found there as well. It should also be mentioned that the printing on the models is up to date and that the line widths are correspondingly fine. The peacock's eye pattern, however, does not go around the corners, which is hardly noticeable in the train set.



This time, the Silberling are delivered without interior fittings. On the cab control car, the window frames in the folding doors of the luggage compartment are embossed black for the first time and reproduce rubber seals.

The window strips, whose frames are finely embossed in silver, look more precisely fitting than before. By the way, the loading space doors of the driving trailer have been embossed in black (rubber seals) for the first time, thus deviating from the original.

Train route signs are printed on the wagons, but also empty holders have been reproduced using pad printing – a bit of variety, that is definitely good. The “Silberling” second class is labelled Bnrzb 725, while its counterpart with 1st/2nd class is labelled ABnrzb 704.

Unchanged, there is only one roof shape for these two coaches, which belongs to the 2nd class coach and does not match the 1st class with the number of fans above the middle passenger compartment. But this is a minor detail that we have been able to get over and accept for over 40 years, especially since many Zetties probably had not previously noticed.

Immediately a shape variant

What we wrote in our test report (**Trainini®** 3/2019) essentially applies to the enclosed locomotive model. As expected, we find the basic chassis conception with pole division in longitudinal direction, adapted current guides, current pick-ups, and modified gearboxes compared to earlier designs again this time.

But, since the firecracker now has the modern DB lamps with separate front and rear lights, i.e., five instead of only three lanterns per front side, it was also necessary to change the light board. Märklin has

understood well here to change the face of the locomotive already in the second edition, and to provide for variety through a first shape variant.

Both models would look great next to each other if they did not belong to different preservation phases of the prototype. Those who don't care about this on the model railway will be happy. All others look forward to further variations of the varied prototype.

The ventilation grilles have also been changed. The outer shape still corresponds to the Schweiger ventilators, but with now vertical lamellas the model reproduces the multiple nozzle ventilators, which especially knew how to better prevent rain and snow from entering the engine room.

The all-round guttering, the detailing in the area of the buffer plank, and the individually attached handle and handrail bars remained unchanged. Märklin also retained the attractive roof design with individual cables inserted in the insulators.



The fine details of the 141 258-4 correspond to the previous version. However, the mounting of pantograph drives, compressed air whistles and striking bells could be improved before painting, so that they also take on the roof colour and shed their plastic shine.

The striking bell and the current collector drives are plastic parts that were applied after painting and show colour deviations from the roof, which are more or less noticeable depending on the incidence of light. The bell-shaped armature motor with low current consumption and best driving characteristics, on the other hand, is also impressive in this edition without any limitations.

We did not like the fact that the pantographs of the first model were taken from the existing parts stock. It should be known by now that they are not exactly to scale. But with such a delicate model as the E 41 / 141, this is all the more noticeable. So, it is a pity that Märklin has not yet abandoned this approach.

Note on the digitisation of the class 141

The digital supplier Velmo has a conversion solution for the E 41 from Märklin in its programme. However, this does not fit the new model that has now been delivered in its current form.

There, too, the light board has to be changed in such a way that in future it can not only display the light change, but also supply all five lanterns with their light precisely. Digital railway enthusiasts will, therefore, have to wait a little longer.

With such a delicate model as the E 41 / 141, however, this is all the more noticeable. So it is a pity that Märklin has still not said goodbye to this.

To make matters worse, this time larger parts of the series have received faulty copies that do not lock when ironed off, which is why after a few minutes at the latest, both pantographs are again in contact with the contact wire or cause the locomotive to get stuck at tunnel portals, if an overhead line is not used.

Our research did not uncover any defect-free model, which upset us, and prompted us to contact Märklin regarding this matter. The quality assurance was able to reproduce the defect on a number of models and has initiated a revised follow-up production, which, however, could not yet be scheduled.



For the first moulded version of the E 41 / 141, not only the lanterns but also the light board and light guides inside the housing were changed. Annoyingly, many of the delivered models do not have pantographs that lock in the lowered position, or lock only for a short time - these out-of-scale parts are no longer in keeping with the times, anyway.

Affected customers can contact the Märklin service directly or via their dealer in order to be able to exchange faulty pantographs under warranty or guarantee, if available.

We consider this step to be correct and consistent, which is why we may also praise it here. So there is actually nothing standing in the way of the new push-pull (commuter) train set to repeat the great success of the class 141, also in 1:220 scale!



The final view falls from the roof of the village church onto the passing local train: The class 141 once belonged, in its chrome oxide green colour dress as a “firecracker”, to the everyday picture. It should still look familiar to many model railway enthusiasts.

We are looking forward to seeing the smallest of the standard locomotives from DB's new construction programme on layouts in the future as numerous as it once was in prototype. If the term “like bread and butter” applies to an electric locomotive, then, it does to this much-loved machine in its most beautiful livery.

With this in mind: have a good trip, little firecracker!

Manufacturer of the models:
<http://www.maerklin.de>

Vlms 63 of ZetNa 220

Only a short Heyday

The Vlms 63 design finally closed the chapter on small cattle wagons at DB. Today, no live cattle are driven to the slaughterhouses in freight wagons. At the end of the 1950s, things looked quite different and the Bundesbahn saw a need to replace its many older wagons. Thus, the wagon whose model by ZetNa 220 we would like to present today was created from the numerous predecessors in their conversion programme.

In **Trainini®** 4/2021, we have summarised the history of the German railroad cars from about 1890 onwards in order to be able to present and classify the model of the V 23 by ZetNa 220. In the meantime we also have the Vlms 63 of the Deutsche Bundesbahn, the last built representative of the main type V, whose history we would like to classify in the same way.

Our prototype section of the above-mentioned article concluded with the transport figures for 1953. In this financial year, the DB had almost 1,600 older types of wagons at its disposal, well over 90 % of which were still from the First World War period, or had even been built before that.

continues on page 14



In the sixties, cattle transport is still a lucrative business for the Bundesbahn. In Brilon, Sauerland, small cattle are loaded from the Hanomag lorry into the upper deck of a still almost new Vlms 63 using a ramp. Photo: Gerhard Tüllmann, Brilon

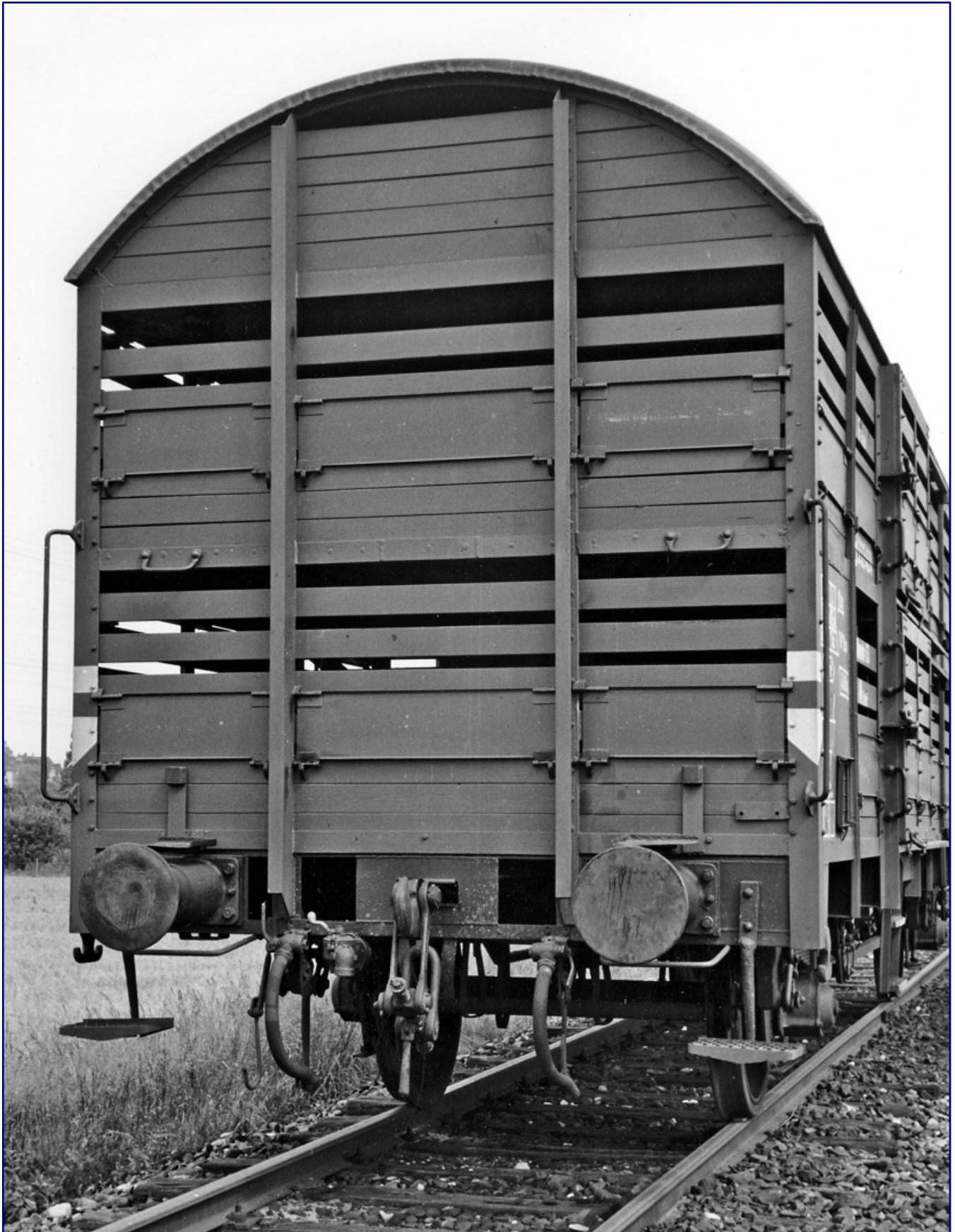

The front side of this Vlmms 63 reveals some deviations from the model of ZetNa 220 with regard to the two front wall struts and the termination of the boarding under the roof. Photo: Bustorff, Eisenbahnstiftung

Modernising the wagon fleet was, therefore, an obvious choice at the time of this last high point in the transport of live cattle. However, the decision to do so was not made until the end of the 1950s. The DB finally extended its conversion programme to include the main class V.

A test car of the new type Vmms 63 with the short service number 240, which identified it, accordingly, was ready for testing at the beginning of 1959. In contrast to the later production cars, it did not yet have a sprinkler system, but, otherwise, showed only a few differences with them.



Although the time of the cattle transports had already expired, the DB still had a total of 650 cars of the type "Vmms 63" built from 1960 onwards. The prototype, equipped with a heating cable, was designated Vmmhs 63, bore the conspicuously short road number 240 and, in contrast to the series-production wagons, did not have an trusses on the wagon floor. Photo: Bustorff, Railway Foundation

The main dimensions and underframe of this type of wagon corresponded to the Gllmehs 50, the impression of which is given by the Märklin model 8605, which has been in the programme since the start of Z gauge. In contrast to most of the covered wagons from the new construction programme, however, the side and end walls of the new construction shed wagon were made of wooden slats that left 40 and 60 mm. wide air gaps for the cattle.

Just like the old livestock wagons, the newly developed examples had two floors, but due to their greater length they had four instead of only two sliding doors on each side and a total of 58 ventilation flaps. Inside they had ten pairs of revolving doors to divide the loading area into compartments. Thanks to double-hook running gear and KE-GP brakes, they could be classified as high-speed trains (secondary class s).

In 1960/61, the construction of the new VImm(h)s 63 from old and reconditioned parts was underway, for which, most of the old cars were dismantled. The Bundesbahn created 650 copies in this way, which eventually almost completely replaced their predecessors; 270 of the new cars had a steam heating line and could be used in passenger trains; 190 had a hand brake that could be operated from a brakeman's platform.

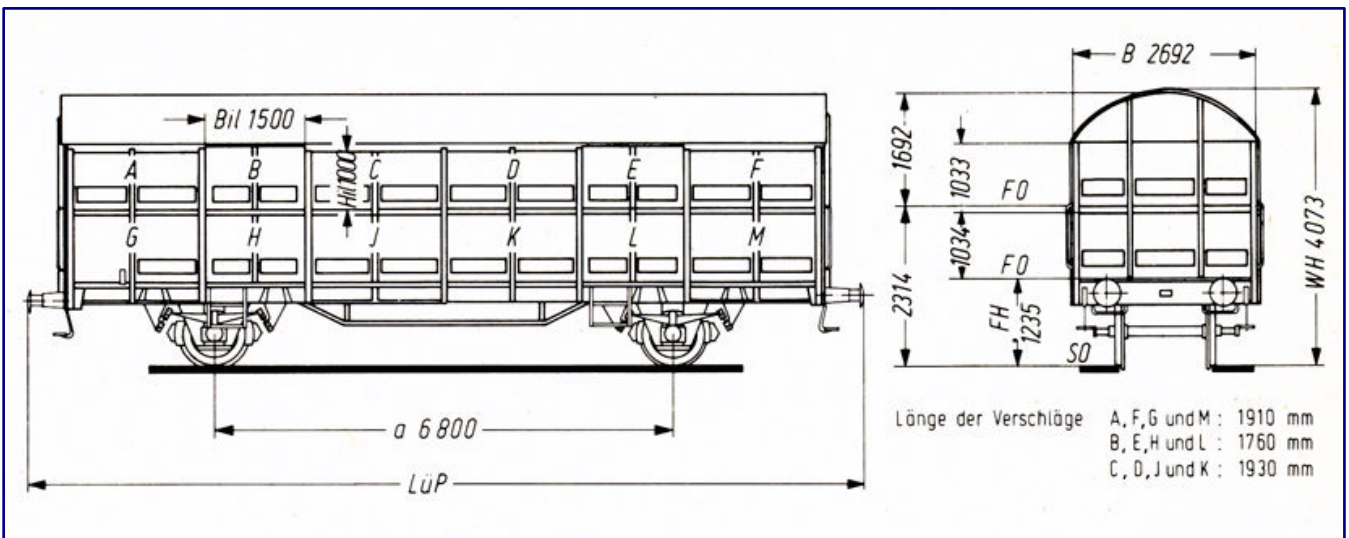

Photo above:

Between 1913 and 1927, 2,133 units of the A8 combination type livestock wagon were built. Designated Vh 14 by the DB, it also served as a parts donor for the Vimms 63 as part of the conversion programme. Photo: Bustorff, Eisenbahnstiftung

Photo below:

DB's drawing provides its customers with information about the most important dimensions, the height of the two loading levels and the length of the individual crates of the Vimms 63 / Hbes 358. Figure: Werbeamt der Deutschen Bundesbahn, Slg. Trainini

Only about 190 examples of the old types were still available after the completion of the conversion programme, and they were subsequently used for the construction of new G-cars. By 1966, all the old types had been removed from service.

But even the newcomers were often not given too long a life. In 1968, they became Hbe(r)s 358 (r from now on for steam heating line) with new service numbers, and, thus, at the same time a special type of covered wagon.

The stocks were already beginning to thin out, as the need for small livestock wagons was continually decreasing. Some of the wagons were converted to the related type Gbs / Gos 245, which we have already touched on with the Märklin model 8605.



From 1968 onwards, the remaining livestock wagons that had not been converted into covered wagons of the standard design were designated as Hbes 358. The photo clearly shows the revolving doors for separating the individual crates. Photo: Werbeamt der Deutschen Bundesbahn, Slg. Trainini

In 1980, the type designation was changed again to Hes 358 with new road numbers. In the meantime, none of the 40 remaining examples had steam heating. At the turn of the millennium, the stock had shrunk to 13 coaches, which are based in Buchloe – at least they had made it into the era of the Deutsche Bahn AG. In the meantime, this type has long since been taken out of service.

The implementation of ZetNa 220

In contrast to the previously delivered model of the V 23, the new DB car was already available in 1:220 scale. It could be found in the programme of Krüger Modellbau, as with the prototype on the chassis basis of the covered wagon related to it. The donor model for this was the Märklin model with item number 8605, on which a new superstructure was placed, and a sprinkler was mounted at the bottom.

ZetNa 220 went a different way constructively and designed for the new products presented here (item no. B002) not only the superstructure with the slatted walls and the smooth roof itself, but also the complete running gear. The production method is identical to the V 23: brass plates form the body and also the basis of the undercarriage.

The axle holders are again made of several layers of brass and carry Märklin wheelsets with pointed bearings, which means that the metal structure cannot be guaranteed to be potential-free. However, the catching brackets for the wheel sets used on the V 23 have now been dispensed with.



Nobly packaged and attractively designed, the Vlmms 63 from ZetNa 220 in Sicily arrives to be put to the test.

As far as the wheelset guidance is concerned, it should be noted that, due to the way the wheelsets are moved, they tend to inhibit the smooth running of the wheels. Lubrication with grease or candle wax can contribute positively to good running characteristics.

Data and dimensions of the crating wagon Vlmms 63:

	<u>Prototype</u>	<u>1:220</u>	<u>Model</u>
Length over buffers	12.500 mm	56,8 mm	54,6 mm
Greatest width	2.772 mm	12,6 mm	13,6 mm
Height over rail head	4.076 mm	18,5 mm	18,3 mm
Body length	11.260 mm	51,2 mm	51,7 mm
Wheelbase	6.800 mm	30,9 mm	30,6 mm
Net weight	14.500 kg	---	8 g
Years of construction	1960/61		
Number of units built	650		

More than two specimens will certainly not be found in a train set, otherwise the relatively high dead weight of 8 grams together with high resistance during cornering due to the large axle base would become a problem at some point. Buyers should be aware of this and choose their combinations carefully.

The coupling guide in the self-built coupling shaft is again a plugged hollow rivet, which can also be pulled and then allows the

exchange of the couplings or springs. Parts from Märklin were used here ex-works, which we also found on the predecessor.

One of the 650 series wagons was chosen as a model, which was obvious. Of course, the model also has the typical explosive system, which only the test car did not have. The superstructure, with the air gaps, sliding doors, and inspection flaps looks successful, and above all "airy", which reflects the prototype impression well.

continues on page 19



The Vimms 63 from ZetNa 220 is certainly not perfect, but it makes a good impression from all perspectives. And, it also stands out for its reasonable price.

The UIC rope hooks are also reproduced, only the handle bars at both ends of the car body have not been reproduced. The paint of the undercarriage and the roof correspond to the prototype colours, the side walls are a little lighter in comparison to the colour edge, which is not disturbing, because it corresponds to the rather weathered condition after a few years of operation.



The first model of a new-build freight car for Z gauge came from Krüger Modellbau (item no. 63555.1; rear) and was based on the Märklin 8605 running gear. The model from ZetNa 220 (B002; front) has been completely redesigned.



E 10 107 of the Bw Heidelberg pulls a Sg (express goods train) with two livestock cars Vlms 63 at the head of the train through Mannheim Rbf on 24 June 1961. The photo provides good ideas for the use on the model railway layout. Photo: Helmut Röth, Eisenbahnstiftung

Legible and again quite cleanly applied are the decals with the white service inscriptions, which assign the model to Era III (Vlms 63) with the service number 332 232. The black chalk field is also visible, but a labelling box is missing. We were a bit irritated by the fact that the RIV inscription is again written in black on a white background. On German wagons it is otherwise also written in white on the brown background.

The adherence to the most important operating dimensions is well done, as our table also shows. The justifiable width deviation is not unusual, in order to be able to maintain the overall proportions and accommodate the undercarriage.



As if made for each other, the new products from ZetNa 220 and the mobile loading ramp from Artitec (322.037) allow for an appealing scene at the loading siding. The last animal has just been loaded and the sliding doors are closed. As soon as the ramp has also been removed, the group of wagons can be pulled off the loading track.

The noticeable deviation in the length over buffers is actually not attributable to the model itself, as the comparison with the almost perfectly adhered to scale car body length shows: Here, as with the V 23, the shortened and too small buffers are responsible, which were designed this way for reasons of operational safety.

If this bothers you, it can easily be remedied by replacing them with other small-series parts. All in all, the overall result is a good one, which is also a sensible enrichment of the Z-gauge range.

If you want to show some variety in your trains and on your layout, you will surely find a suitable model for your request at ZetNa 220, which is beautifully and appealingly designed and also remains affordable. By the way, the mobile loading ramp (322.037) from the Artitec programme is also a suitable addition, which is made for exciting loading road scenes with small cattle loading wagons.

Supplier of the model:
<https://sites.google.com/view/zetna220/home>

Loading ramp as an addition:
<https://www.artitecshop.com>

Ihre Bildsammlung braucht einen sicheren Hort!

Unsere Aufgaben:

Bildsammlungen:

- **bewahren**
- **bewerten**
- **veröffentlichen**

Eisenbahnprojekte:

- **fördern**
- **initieren**

Unsere Garantien:

- + **personenunabhängig**
- + **sicher**
- + **gemeinnützig**
- + **steuerlich privilegiert.**

**Sie möchten
eine Sammlung
der Nachwelt
erhalten?**

0173 / 295 19 21

Rufen Sie uns einfach an!

**Sie möchten
unsere Arbeit
unterstützen?**

Spendenkonto:

Sparda-Bank West

Kto.: 579 484

BLZ: 330 605 92

EISENBAHNSTIFTUNG

JOACHIM SCHMIDT



www.eisenbahnstiftung.de

Self-built track ramps (Part 2)

Construction of the Ramps with Arcades

After our reader Heribert Tönnies presented his preliminary considerations and plans in the first part, and looked for suitable building materials, we can now get to work. A ramp with completely open arcade inserts is now created in an inexpensive way. Another version will also be presented later on.

From Heribert Tönnies. First of all, I will deal with the ramps that take up the exit track from the depot to the main line, as well as, the track to the industrial park. Because these ramps are located directly at the front of the layout, I want to have the greatest possible visibility here: The arcade arches remain completely open, so that especially children, but not only them, can look through here. In addition, the access road to the industrial park is led under the ramp through one of the high arches on the left.



First, I cut the two side walls of the ramp from 3 mm. thick balsa wood in the required length and height. To save wood, I first make a rectangle: length = ramp length, height = ramp height. Then, I only need to make a diagonal cut by joining the two opposite corners and thus I already have the two side walls (see photo above).

I place the still complete strip rings on one of the two sides of the ramp, the upper edge of the circle flush with the top of the ramp, and trace the inner arc with a felt pen. Keeping the same, previously determined distance between the arcs at the lower edge according to variant a), in my case 7 mm., I draw all further arcs.

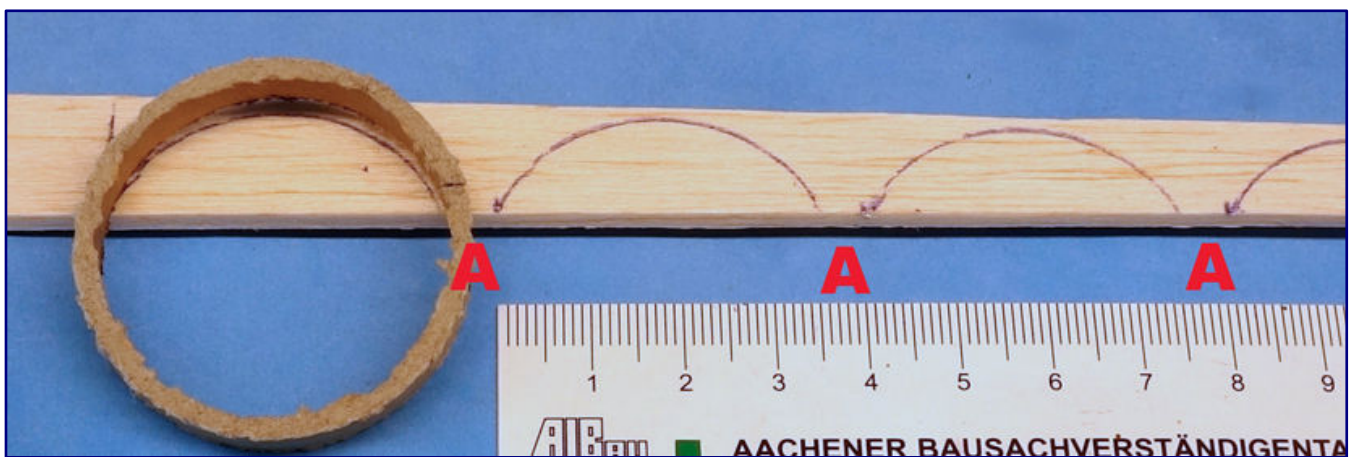

The inner arcs are marked on the wooden strip with a felt pen (photo above), then the circle segments can be shortened to fit and glued on (photo below).

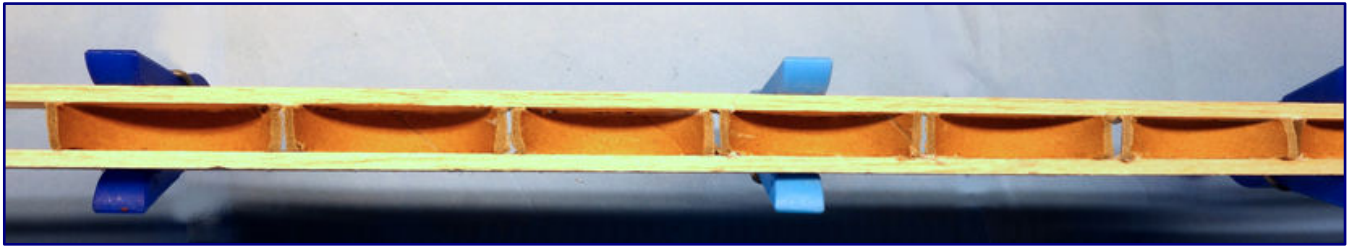

After gluing on the second side of the ramp, clamps fix the component until the glue has set. Care should be taken so that no glue should come out on the inside shown here.

Now, I can shorten the arch strips to the required height and glue the circle segments to the side wall with wood glue. To prevent the balsa wood from warping due to the one-sided absorption of liquid from the wood glue, I weigh down the component (e.g., with books).

Tip "Component marking"

As already described elsewhere, I recommend marking the components with "bottom" (b), "top" (t) etc., in a place that will later be invisible.

Especially with the flat slopes of the ramps it is possible to confuse the top and bottom. An incorrectly glued component would be nothing but scrap.

After tightening the glue, I apply the wood glue to the free edges of the circle segment arches and glue the second ramp side on top. To set, I fix the parts either with clamps or (screw) clamps.

Wood glue that comes out in the area of the later open arches should always be scraped off immediately with a small piece of wood or similar. Because the arch cut-out will have to be cut out here later, there must not be any tough glue bead there, which would otherwise be very difficult to work on with the craft knife.

On the other hand, wood glue that oozes out of the top of the arches is desirable because it creates a larger gluing surface that gives the construction more stability. The first two ramp blanks are now already glued, and the following photo shows a view from above and below.

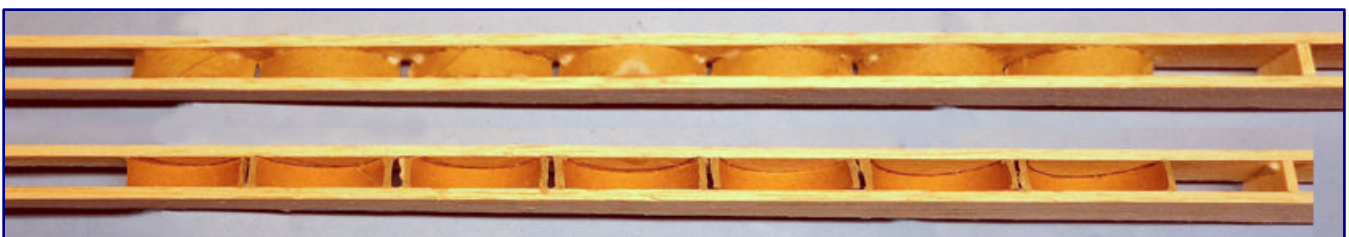

Now, all that remains is to cut the open sheets cleanly out of the side walls. To do this, I carefully run the knife along the inside of the cardboard sheets.

To make it easier, I cut out the side panels to be removed in advance with a generous margin to the circular arcs (mark A in the photo on the right). For the final fine cut, the side wall can also be left slightly beyond the circular arc (mark B in the photo on the right).

The balsa wood, which is easy to work with, is very easy to sand with sandpaper so that the edge to the board can be easily adjusted and smoothed. This procedure has the advantage of avoiding a bow that is accidentally cut out too large and time-consuming spatula work.

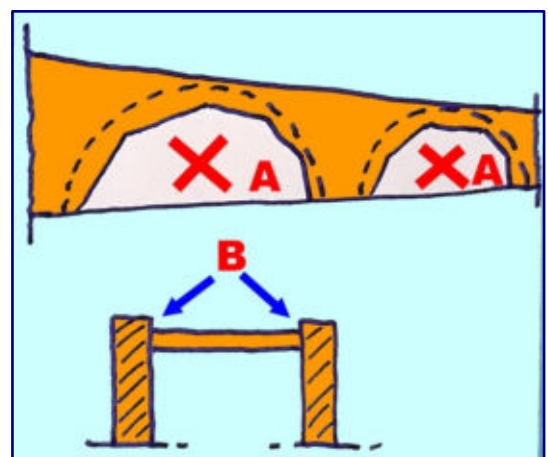

I decided to use this method for stability reasons: The ramp is very resilient due to its box shape. However, it is also possible to open the arches in the first step, which follows the gluing of the first side. I advise against this, however, because a side wall that is only glued on one side poses a risk of breakage when working with the quite large lengths.

The result of my blanks already looks promising. At the ends and beginnings of the ramps, where there are no round arches, I glued in small crossbars made of balsa wood to increase the stability.



This is what the intermediate result looks like after the steps described so far. The markings A indicate the crossbar connections made of balsa wood to stabilise the ramp.

In the next construction step, the top of the ramp is closed. This surface also serves as a track support. Different variants are possible here, both in terms of construction and width.

continues on page 26



The large overhang on the ramp is placed in the direction of the viewer's main field of vision, i.e., towards the front of the layout. Safety exits in confined spaces, as found on the Moselle line (see photo on page 25) are also worth replicating.

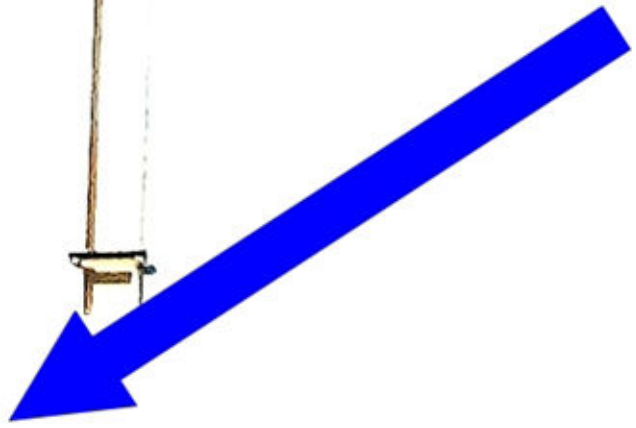

Because I have to build as space-saving as possible, my little prize winners are not offered a separate and raised walking area next to the track. In the prototype, there would therefore be an absolute ban on walking on the track when it is not closed. Instead, there are safety exits at regular, shorter intervals, as can be found on the Moselle line, for example. In addition, I decided on an asymmetrical design for the ramps.

Usually, the walking areas next to the tracks on bridges or ramps protrude laterally, i.e., project beyond the vertical ramp walls. Although I don't design walking areas, I resort to this trick to increase the three-dimensionality. I place the large projection in the direction of the viewer's main field of vision (front of the layout).

For the top of the ramp, I call it the top plate, I cut a 26 mm. wide board from a 1.5 mm. thick balsa wood board. In reality, this corresponds to a concrete slab approx. 30 - 35 cm. thick, which is realistic for carrying the heavy load, especially with cantilever arm.

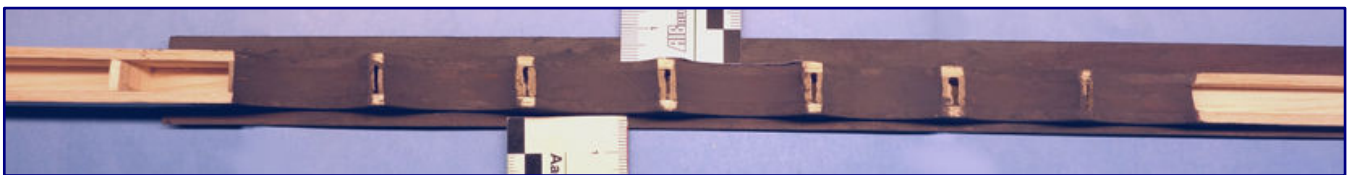
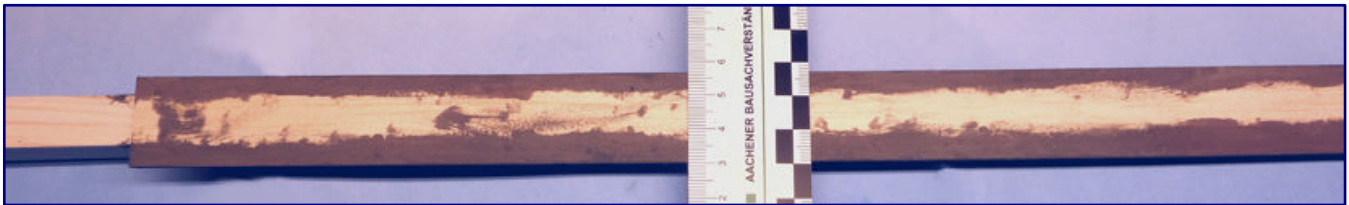

Along the edge, the top and bottom are coloured with a dirt shade to effectively conceal possible inaccuracies during further work (photo above). Then the cover plate is glued to the top of the ramp with wood glue (photo below).

If this is too thick for you, you can use the “beveling” trick already described in my book. The edges should not be sanded absolutely smooth later, because this is old Bw. You can see in the photos that this slightly rough edge looks like old, brittle and already slightly flaking concrete – and thus absolutely realistic.

In order not to have to paint along the prints to be glued on later (photo-realistic concrete reproduction), I colour a strip along the edge on both sides of the lower and upper side with a dirty grey-brown shade. This way I only have to do minor cosmetic work later without running the risk of irreparably soiling other components.

I glue the prepared top plate to the ramps with wood glue. It is important to keep the different protrusions (7 mm. at the front and 4 mm. at the back) and to keep the edges of the top plate parallel to the side walls of the ramp.

To avoid the cover plate bending up due to the wet wood glue, I either fix the cover plate to the ramp walls with pins or weigh down the construction.

For the design of the ramp walls, I decided to use a photo-realistic reproductions, as already mentioned. I found a suitable photo motif at a former jetty with an arcade construction for the unloading cranes. Its weathered concrete is ideal and the shape of the arches can also be adapted well for my purposes.



The arcade construction on a former jetty provided the photo template for a print motif that was used.

In the image editing programme, I “cut out” the individual arches and distort them in such a way that their dimensions match my prepared arcade arches as far as possible. In different variations, I combine several of these concrete arches to form a structural arch – I offer this structural arch for free download on my website.

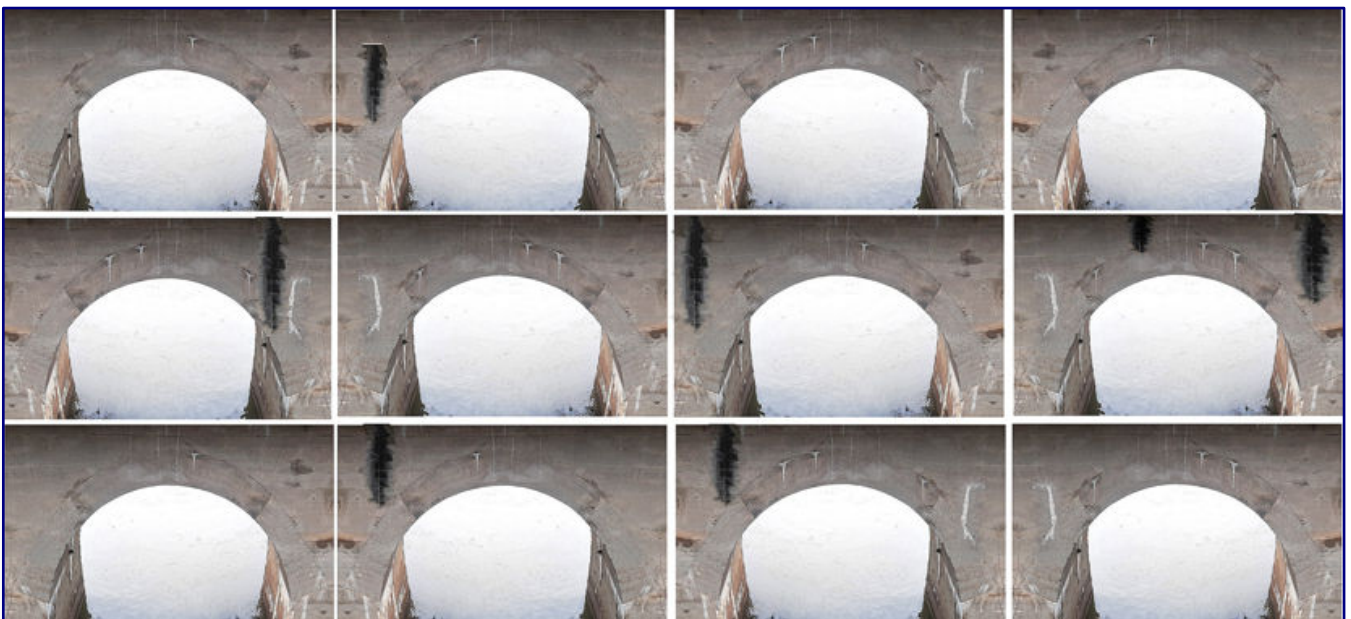

Extract from the printed sheet with the sheets for the building project adjusted by distorting and changing the dimensions – also offered on the author's website.

Printed on 180g/m² matt photo cardboard at the appropriate enlargement level, I get a prototypical look. I glue one element cut out in the required width with all-purpose glue to the side wall, with the upper edge close to the cantilevered top plate.



In the centre of the pier, the butt edges are not to be aligned exactly: they will still be covered by a brick masonry support later on.

Tip "Cut off paper lamination cleanly".
Always leave the paper overlay (lamination) protruding slightly over the component (e.g., along the round arch). After the glue has dried, use a scalpel with a new (sharp) blade to carefully cut off the protruding paper edges along the wooden construction.
When doing so, guide the blade from the outside to the inside and do not return it in the saw cut (i.e., do not cut back and forth), but always in one direction. This prevents the paper from tearing and fraying. Then, sand the edge cleanly with 600-grit sandpaper, again from the outside inwards.

In order to be able to position the element axially accurately, I cut out the arch in advance, but leave the cut-out 1 - 2 mm. smaller so that I can later cut along the edge of the building with an exact fit.

The butt edges of the individual elements do not have to be worked absolutely precisely in the centre of the pier, because a brick

masonry support in front is still glued on here. The finished side wall can be seen in the photos.

For the pillars I need thin strips of balsa wood about 3 mm. wide, which I cut from a 1.5 mm. thick balsa board. I achieve the brickwork replica again by photorealistic lamination.

As a model I chose the façade of an older industrial building, which already shows some spotting. Using a drawing program, I again add individual segments offset and optimised, so that a complete DIN A4 sheet is filled with brick masonry structure. This structure can also be downloaded from my website, but here 3D foils from Redutex are also available as an alternative.

In contrast to the concrete arcade arches, however, I only print out the brickwork on 80 g/m² paper so that the fine edges remain sharp and are easier to crease.

I cut out approximately 8 mm. wide strips with a horizontal structure from the printout and glue them with all-purpose glue in the middle of the 3 mm. wide pillars. Then I fold the lateral edges backwards at the edge and glue them to the sides. I fold the overhangs at the back, which are still approximately 1 mm wide, to the back, and glue them there too.

The advantage of laminating around the back is that the pillars can be glued neatly to the substrate with no gaps. One disadvantage, however, is that the slight curvature can cause a hairline gap to the background despite the thin paper.



The pillars made according to the instructions in the text are presented to the viewer here before their further processing.

If this must be avoided, the paper lamination may only be passed around the sides and must be cut with the reverse side absolutely flat. However, there is then a risk that inaccuracies will occur. In this respect, everyone should try out and use the most suitable method for themselves.

Now, I just shorten the pillars to the required length and glue them exactly in the middle between the concrete arcades using all-purpose glue or wood glue. So that nothing slips, I fix the pillars at the top and bottom with pins.

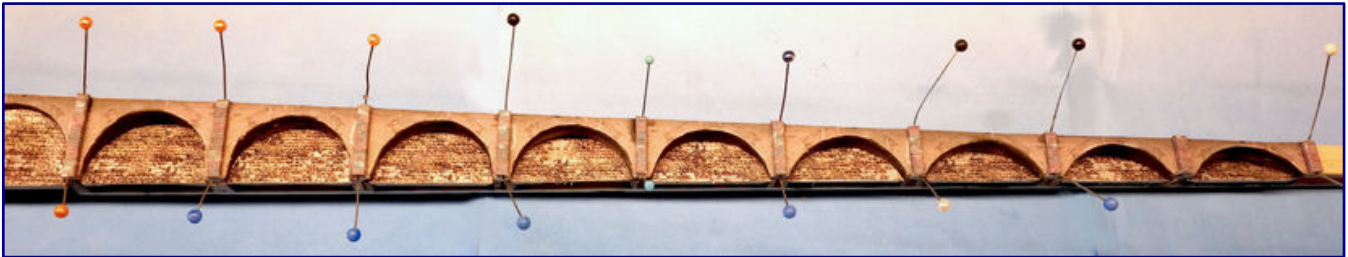

Until the adhesive sets, the pillars are fixed to the arcade base with the help of pins.

Caution: It is easy to align the pillars at right angles to the upper edge of the ramp. However, this leads to them being crooked by the angle of the ramp slope when the model is installed. Therefore, they must always be aligned perpendicular to the lower edge.!

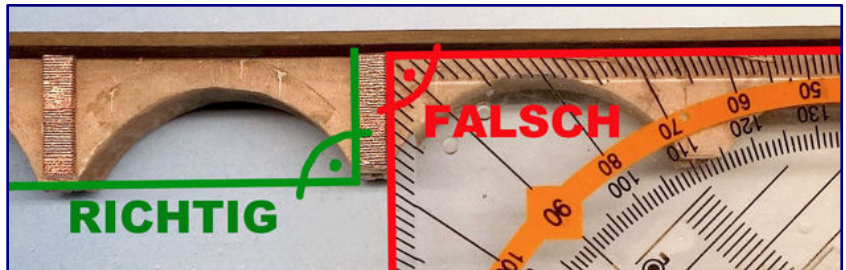

In order to give the “show side” of the ramp some additional structure, I make small cantilever arms from balsa wood that support the widely projecting top plate in the area of the masonry pillars. This proves the need for the pillars and gives the top plate a nice structure on the underside. By the way, this design is statically also prototypical. I cut these parts from a 2 mm. thick balsa wood board in the dimensions according to the sketch (details in millimetres).

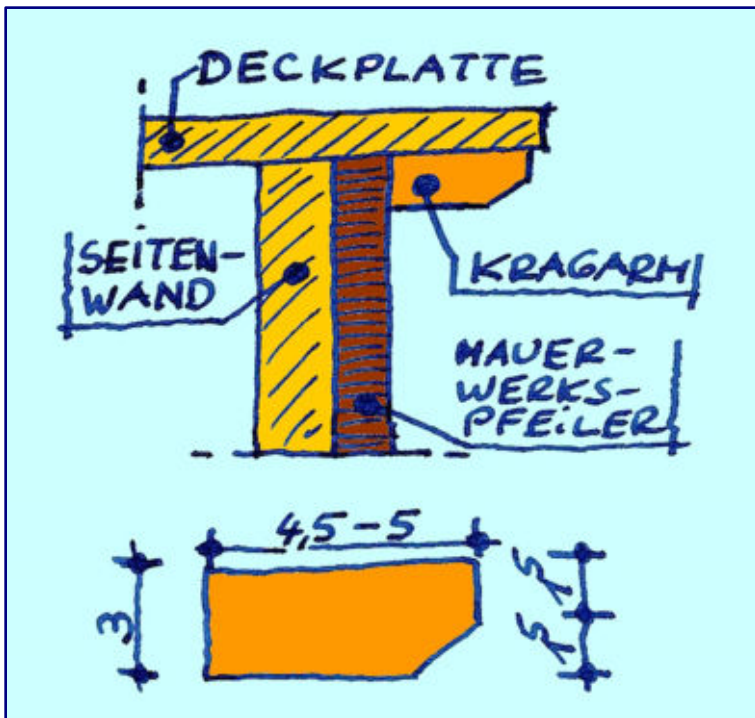

The cantilevers can be painted concrete grey before installation, but with a steady hand and a fine brush it is also possible after installation. I use wood glue to glue them centrally in front of the supports and on the arcade-free surfaces on the side of the wide cantilevered top plate.

Due to the short projection of the cover plate on the rear side of the ramp, cantilever arms are not necessary here, neither for prototypical nor for hobbyist reasons.



The cantilevers are glued on as shown here, but only on the side that will later face the viewer. The other side remains without these cantilever arms.

As already described at the beginning, I choose parapet walls on both sides as fall protection. A natural stone wall would fit in well with the theme of my installation. Due to the construction, however, such walls are relatively thick, unless it is a facing construction: "thin" natural stone slabs on a masonry or concrete core.



The brick look is also used for the parapet walls. In this way, the structure of the pillars is repeated to a certain degree.

However, such elaborate constructions were generally not used for the purely functional buildings of the railway. So that the structure of the pillars is repeated, I also use brick for the parapet walls.

This fits into the overall picture of the layout anyway, because at various points I also use retaining walls with double T-beams and brick masonry panels in between (theme: uniform construction methods and no "architectural exhibition").

Because many parapet walls are needed, I make them rationally in a larger stock. To do this, I print out several sheets on paper (80 g/m²) from the brick masonry template already described and cut them along the masonry structure into strips about 10.5 cm. wide.

I glue these strips on both sides with Uhu glue to a 10 cm. wide, 1 mm. thick and 60 cm. long balsa wood board (3 DIN-A-4 long printouts in landscape format fit on the 60 cm.). A longer length makes no sense, at least on a scale of 1:220, because the fineness makes further handling impractical.

Tip "Avoid bending up with larger components".
As already described above, the soft and open-pored balsa wood very easily absorbs moisture (e.g., from the glue). Because the wood expands on the damp side, this causes the balsa wood to bend upwards, which can hardly be returned to its original flat shape after drying.
Gluing the masonry structure on both sides at the same time already reduces this tendency considerably, but cannot completely prevent it from bending up.
However, because the adhesive diffuses somewhat through the glued paper due to the large surface area, no large-scale weighting can be done during drying (e.g., with books). The thin paper lamination then sticks to the weighting and is destroyed when lifted off.
I therefore take a thicker, stable (balsa) wooden board and fix the balsa wood plate glued on both sides to it with pins. In my experience, the paper does not stick to the underside with this method, because the lack of weight creates a minimal air gap that prevents this and allows the underside to dry quickly.

The Uhu all-purpose glue has the advantage that it "sets" relatively quickly and thus counteracts any curling of the paper due to excessive moisture absorption. However, a suitable spray adhesive can also be used. But because I am working at my desk (for the time being) and want to save myself the work of covering up against spray mist, I reach for the tube.

After the balsa wood laminated on both sides has dried well, I cut strips approx. 5 mm. wide parallel to the masonry structure with the craft knife. In Z gauge this corresponds to a real height of

approximately 1.10 metres. The thickness of 1 mm. represents a scale wall thickness of approx. 24 cm.

A thinner wall (e.g., 0.5 mm.) makes no sense and can no longer be processed cleanly. If you want it even finer, you would have to resort to plastic boards profiled with a brick look.

For the concrete covering of the wall, I take a 0.8 or a 1 mm. thick balsa wood board and paint it in an approximately 3 cm. wide strip on both sides in concrete grey, whereby I tend towards grey-brown due to the degree of soiling. The colour structure may become “streaky”, which emphasises the different levels of dirt. In addition, there will be a colour after-treatment later anyway.



After drying, cut off strips approx. 1.5 to max. 2 mm wide. The cut edges that are still rough from the cut are painted concrete grey to brown (photo above). They can then be glued to the centre of the prepared masonry strips using wood glue (photo below).

After drying, I cut off strips approximately 1.5 to max. 2 mm. wide. I also paint the cut edges that are still rough from the cut concrete grey to brown. Then, I glue the narrow strip in the middle of the prepared masonry strips with wood glue. The wall is now finished and can be glued onto the ramp.

In order to achieve a greater three-dimensionality with the wall disc, I do not glue the wall flush with the edge of the ramp directly at the front, but about 0.5 to a maximum of 1 mm. back (see arrow in the photo on the right).

In this way I create a small protrusion that gives me the opportunity to compensate for minor inaccuracies later and, if necessary, to cover them up with wildly growing greenery (photo on the right).

Because of the great length and the fineness, they cannot always be avoided. By the way, I use express wood glue (Uhu Holzleim D2 Express) to be able to make minor corrections during gluing.

If it comes out on the outside, it should be removed immediately. On the inside, on the





Arcades make no sense in the low ramp area. Therefore, the brick masonry structure is used there again.

other hand, a small groove can be created, because this creates greater stability and will later be covered by ballast or the like anyway.

Small inaccuracies cannot be avoided here and there over the great length with the thin wall strip. Most of the time there is a small gap in some places. I close this gap with wood glue applied with a toothpick. The glue often pulls back quite far after it has set. These areas can then be covered very well with green landscaping or with moss made of green paint of a thicker consistency.

In the low ramp area (beginning of the ramp), arcades make no sense. Here, I cover the ramp walls with the brick masonry structure, printed either on 180 g/m² or 80 g/m².

Because I apply the structure only after gluing the brackets, I have to cut it out of paper. It is easier to glue on the masonry structure before mounting the brackets. With this, the two front ramps are essentially finished, except for colour finishing and landscaping.

Ramp with partially open and closed arcades

I build the rear ramp in the same way. Only the open arcades have:

- A) Closed parapets in the lower area (due to the rising terrain behind),



- B) in the middle area, vertical wall panels in the arches (due to high terrain behind them), and
- C) sloping walls on the right (because the height of the arches is lower here and the terrain behind the ramp is almost at and later even above the top of the ramp).

A retaining wall to the locomotive shed will then be built here at the rear along the ramp.

Although the terrain rises at the back, I leave the three left arcades open in the upper round arch area to emphasise the openness and the detail. Similar designs also exist in prototype.



Retaining wall constructions can also be found on the prototype (photo left). The author took this up and built a passage with stairs to the locomotive depot (photo right).

Here, I will realise a pedestrian passage with stairs between the electric locomotive depot at the rear and the siding in front of the ramp (e.g., for an electric locomotive).

The remaining arcades are given a slightly recessed wall. For this purpose, a vertical wall is built from the left in the 4th to 6th arcade, the remaining arcades to the right of it receive a wall that rises obliquely from the front below to the back above, which particularly beautifully underlines the three-dimensionality of the then free-standing round arches. This construction was also common in the past.

The rear ramp wall does not need to be cut out in the shape of a round arch when the arcades are to be filled, because the substructure of the terrain is against it here anyway. For the infill, I draw the round arches on a 3 mm. thick balsa wood board and cut out the components to fit exactly.



Where the arcades are filled with a wall, the rear ramp wall does not have to be cut out (see right in photo).

Tip "Template"

Because several arch segments have to be prepared as infill, it makes sense to cut out a template of an arcade arch and trace the outlines of the infill from here.

An already completed ramp with arcade arch (without mounted cantilever plate) can also be used as a template, the guidance of the pin must then be carried out somewhat more meticulously due to the thickness of the ramp.

The sloping fillings must, however, be bevelled at the back on the upper and lower edges so that they reach into the top of the round arch and fit tightly there with the front side.

And don't forget to number the parts, as it saves a lot of trial and error when gluing.

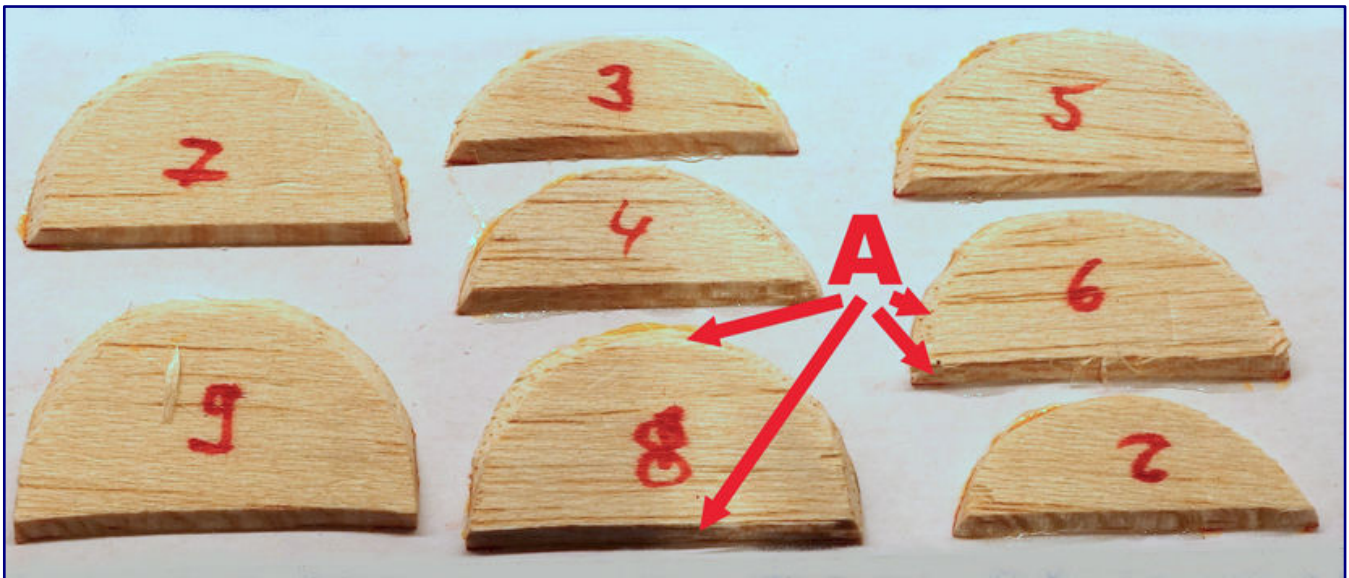

The slanted fillings are bevelled at the back on the upper and lower edges so that they reach into the top of the round arch and fit tightly there with the front side. Numbering the parts helps later in installing them correctly.

In contrast to the piers and the fall protection made of brickwork, I choose a walling of natural stone for the closed arcades. This matches the supporting walls of the stained slate rocks and thus creates the connection to the left side of the layout.



For the natural stone masonry, a photograph of the Zons Fortress served as a template, which was scaled as visibly as possible.

With the three materials (concrete of the arcade arches, brick masonry of the pillars and parapet walls, and natural stone of the wall panels as arcade filling) there is enough “visual” variety, that more is not necessary.

For the natural stone masonry, I am again compiling a DIN A4 page structure of a masonry taken at the Zons Fortress on the computer in an image processing programme. I also offer this structure for free download on my internet pages.

Tip "Paper margin"
There will always be smallest inaccuracies between the arcade round arch and the filling element to be inserted. To avoid gaps between the round arch and the brickwork, I leave the structural lamination minimally over the wood on all sides.
When inserting the filling element into the round arch, I then press the paper, which is soft from the glue, into the slot or against the arcade arch. If there are any small steps due to the thickness of the paper, they are either not visible or will be covered up later with the colour finishing.

Printed on either 80 g/m² or 180 g/m² paper, I glue the structure onto the cut-out filling elements with all-purpose glue. Due to the masonry captured in grazing light and in extremely high resolution, a high optical three-dimensionality is still achieved even with two-dimensional printing in Z.

The segment shown on page 34 has a stone height of 25 - 30 cm. when converted to original size, which is fine for a rubble stone wall, but still leaves the structure visible in Z gauge. Here, too, the use of structural foils is possible, as an alternative.



From this perspective, the versatility of the ramps and arcade arches can be clearly seen. Vegetation overgrowth and ageing contribute their part to the effect.

The rear arcade then presents itself with the left-side connection to the bridgehead of the crossing bridge structure designed in concrete.

As already mentioned at the beginning, I will lay the tracks as centrally as possible on the ramps. In order to meet the safety needs of the figures and the occupational health and safety regulations, I will install safety exits at intervals of approx. 13 cm.

This makes the ramp look more relaxed and is certainly a rather rare feature on layouts. In order not to overload this construction report, I will refrain from describing the rather simple reconstruction of this steel construction with only approx. 7 mm. high exits.

Finally, I weather the whole ramp construction. This includes the ageing of the concrete, dark green water drainage traces, white sintering, mossing and careful greening with hanging and creeping plants. I have already described the procedure in my “Volume I of Practical Instructions” and the subsequent titles.



You will also find further tips, e.g., on rock and path construction in the papier-mâché version and background information on the historic Bw with many old photos and reproduction instructions in the books published so far, which I offer via my website. Now I wish you a lot of fun with the layout to be built according to your own creative ideas.

All photos and drawings: Heribert Tönnies

Pages of the author:
<http://bestagernet.de>

Source of supply for Redutex:
<https://www.1zu220-shop.de>

Adhesive used:
<https://www.uhu.de>

The first driving tests (Part 2)

Curved Tracks on a good Foundation

After basic considerations and introductions to track geometry, today we get down to work. To ensure that the first layout is a success right from the start, Dirk Kuhlmann gives hints and advice for an attractive and successful track layout, as well as successful woodwork that makes a convincing landscape possible in the first place. "Done right from the start" is the goal and result of his instructions in this sequel.

From Dirk Kuhlmann. Welcome to the second part of our fundamentals for a successful specimen of model railway. This time we want to show you a little bit more about working with flex-tracks and the necessary woodwork.

We already noticed in the first episode that the track systems from Märklin and Rokuhan are mature in themselves and leave only a few wishes unfulfilled. However, when it comes to highly sophisticated curves, the finished track bodies reach their aesthetic limits. Here, as with other scales, a flexible and longer track provides a welcome remedy.

Märklin flex track is 660 mm. long and thus combines six straight standard 110 mm. tracks in a single product. Before its use as a generously sweeping curve, however, it is necessary to remove the underside connections of the sleepers reciprocally with a sharp knife so that it can be bent without kinks.

continues on page 39

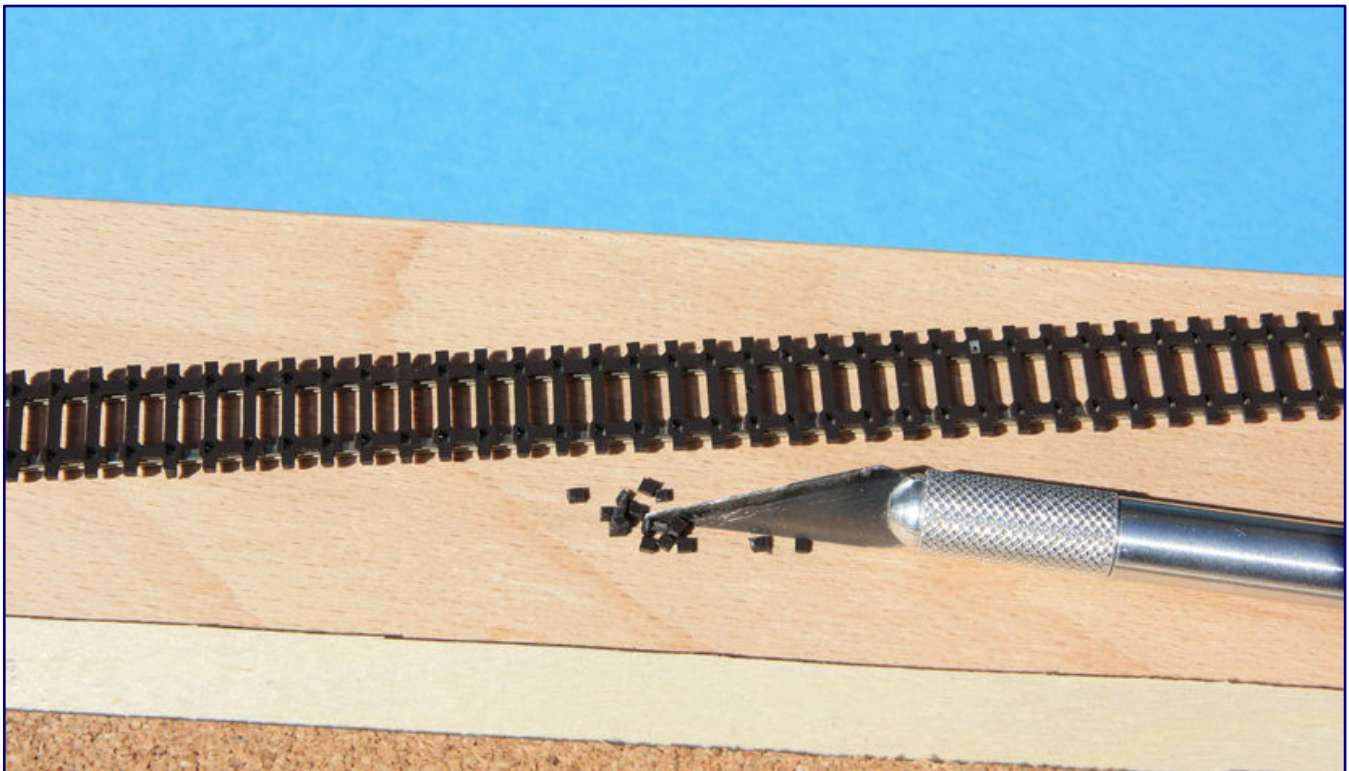

The flex track is perfect for elegant track designs, but handling it needs to be learned: The sleeper band can be opened alternately on the underside.

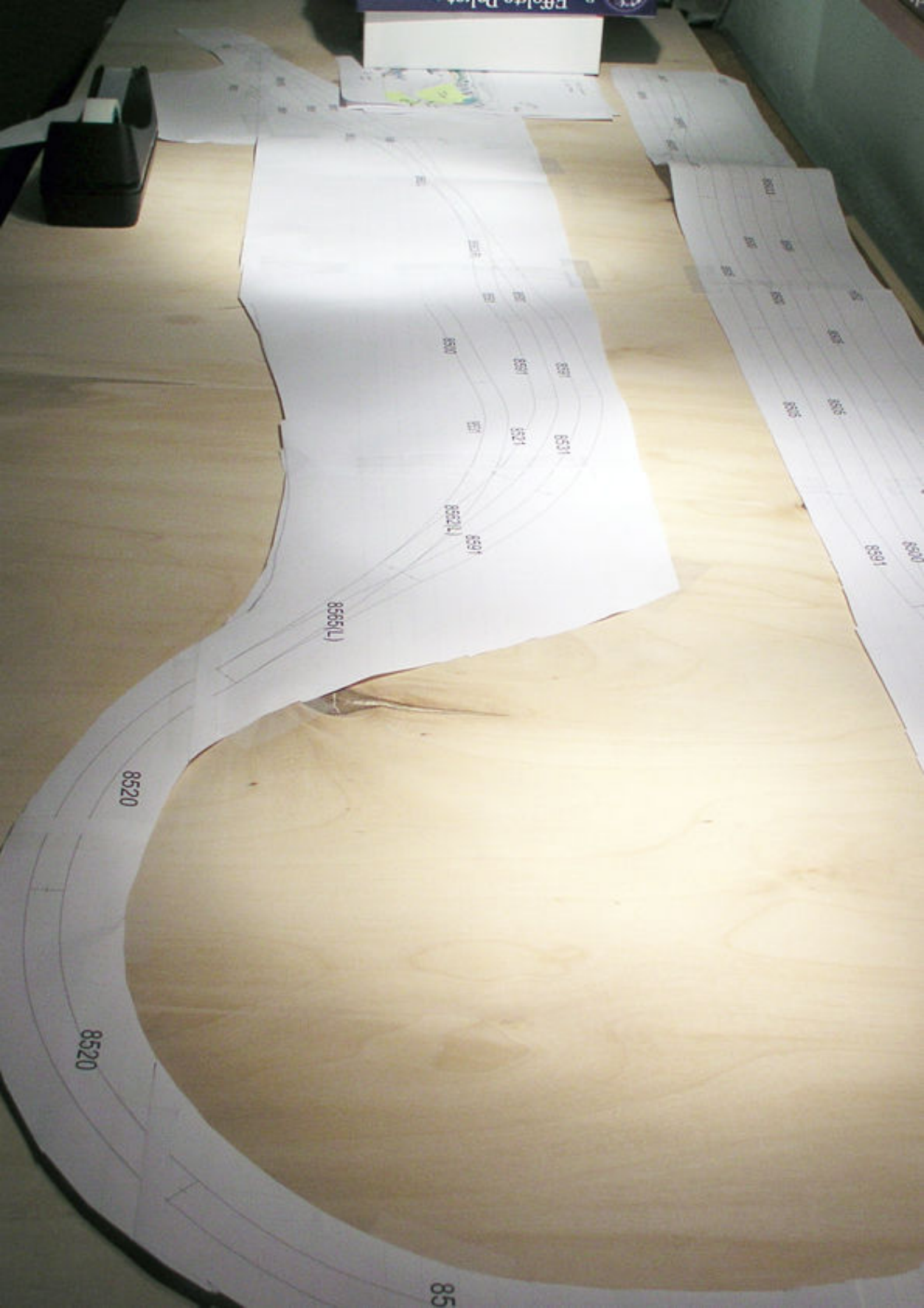

Field Plot

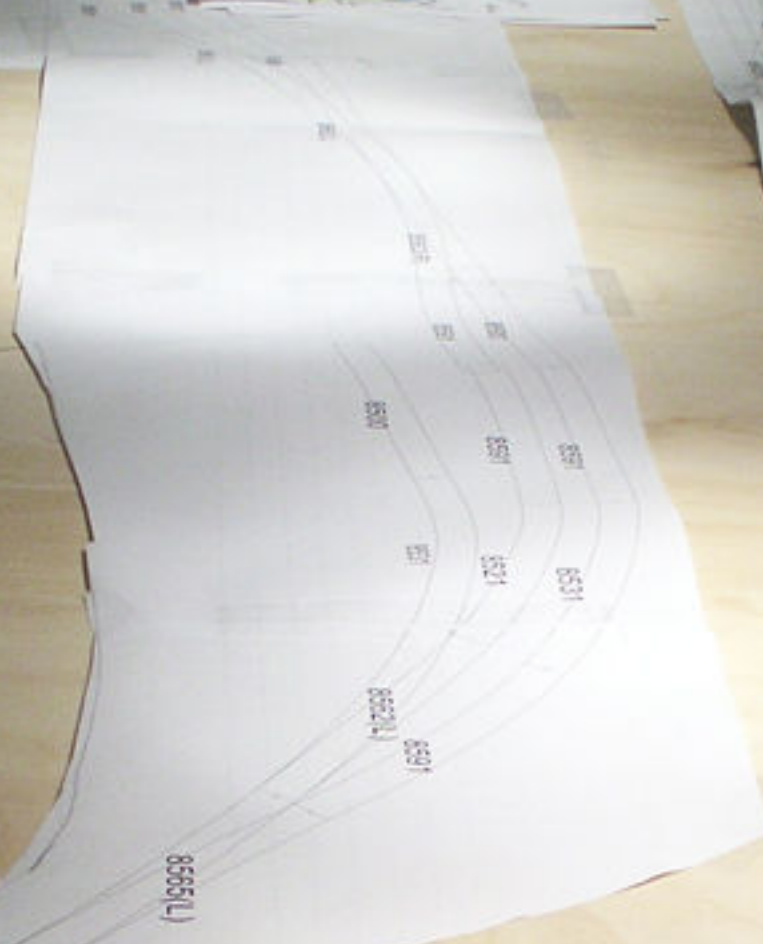

The beginner is now recommended to use a 1:1 printout of his track plan as a useful and feasible template (see photo on page 38). This way, even a (perceived) rather complicated flex track can find its position on the layout.

Since my beginnings, I have been working out a first curve with the help of the tried and tested spacer sticks, steel rulers and pins. The well-known Krause clamps (Fohrmann; art. no. 01 425) retain the track in the desired shape. I see this purchase as an absolute “must have” for this work! They represent a one-time investment that pays for itself quickly and permanently.

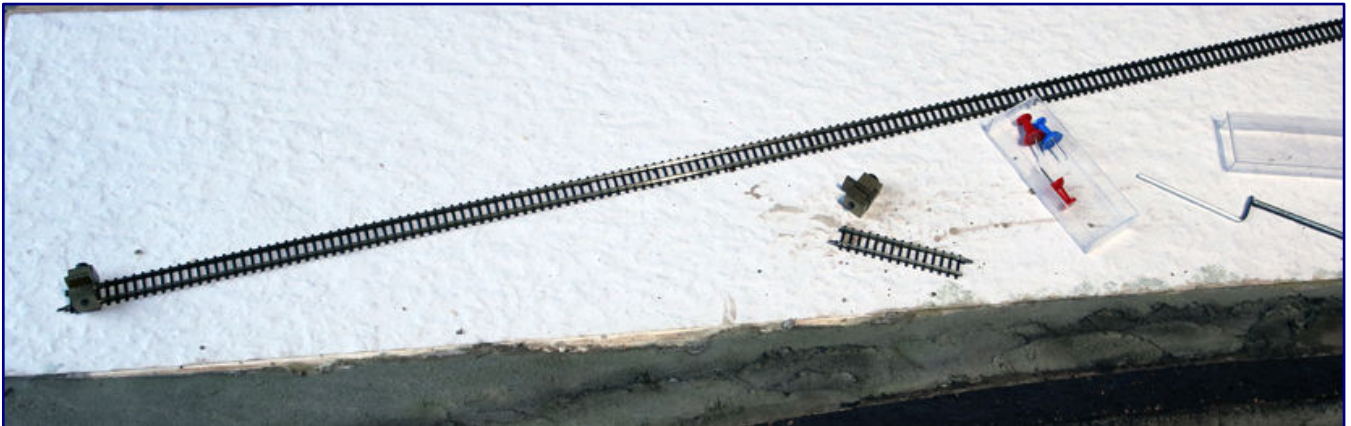

When working with the flex track, there is no way around Krause track clamps (in both photos) in the long run – a good and useful investment.

The subsequent and necessary trimming is done with the help of a jeweller's saw bow and a fine saw blade (32 teeth/cm.), afterwards track fixing nails (Märklin 8999) help to fix the sleeper strip to the base.

A facet-free side cutter also serves its purpose or the rather well-known track saw from Roco helps to shorten the outer rail to the dimension of the inner sibling. Only after the correct installation I remove the clamps. But one hint is important for me: Do some test work with used track, so that the different steps can be learned correctly, before you get down to real work. After the work is done, the big reward is a true-to-scale track layout.

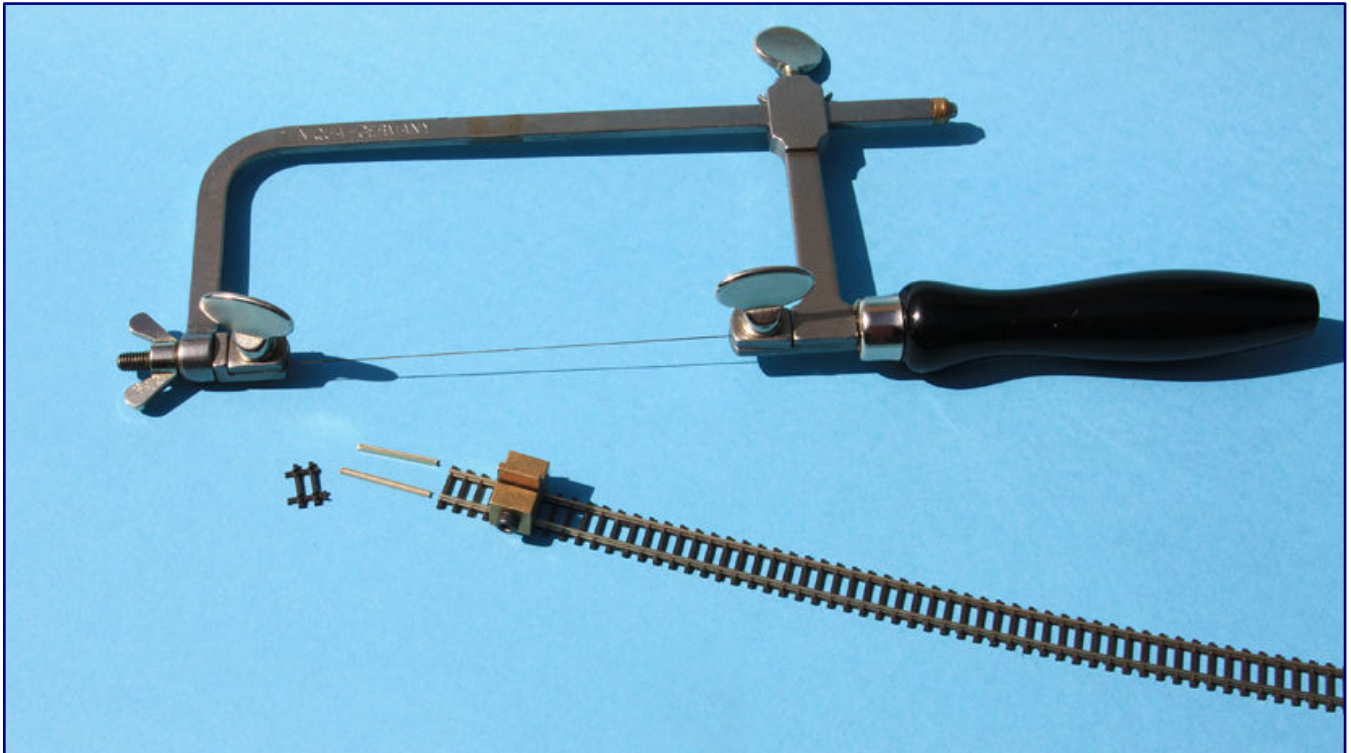

It is easy to see how the flex track was twisted into a gentle curve and fixed with the Krause clamp. The rail ends are now to be cut absolutely parallel and bevel free.

Woodwork with care

Let's now move on to a topic that causes model railroaders much more headaches – regardless of whether they are beginners or “old hands”: The wooden construction for their own small world. It is often simply called the “railway board”. And, all too often this expression is also implemented in this way.

continues on page 42

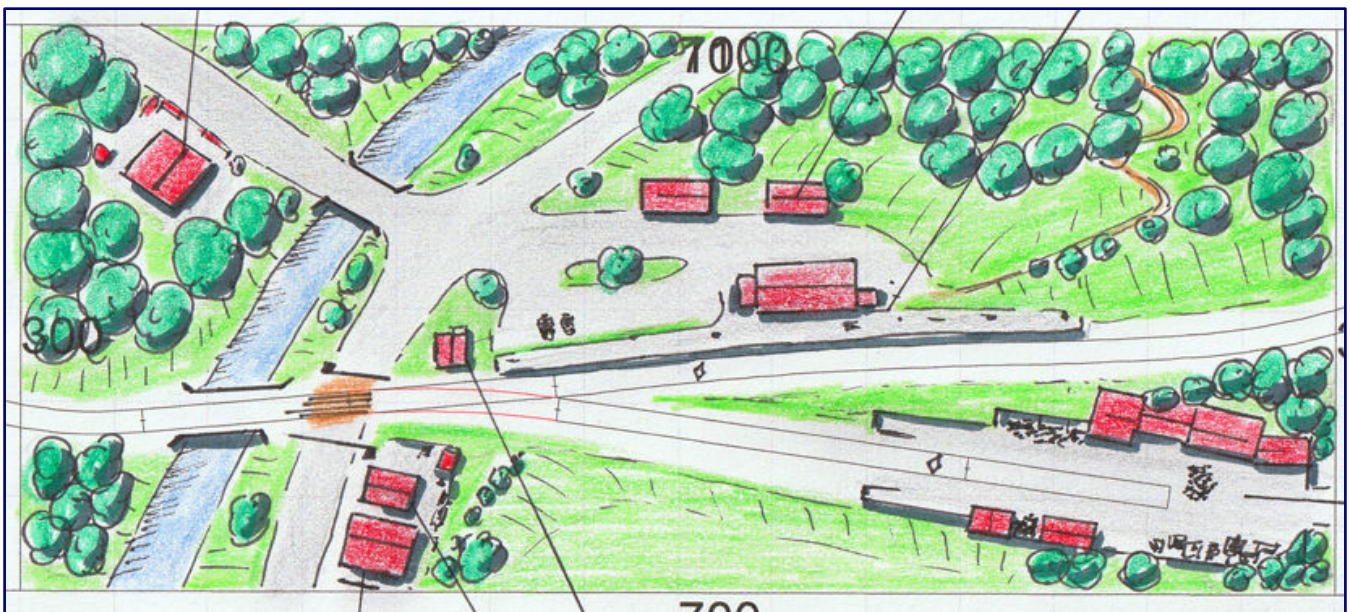

Sketch of the “Upland” exhibition layout.

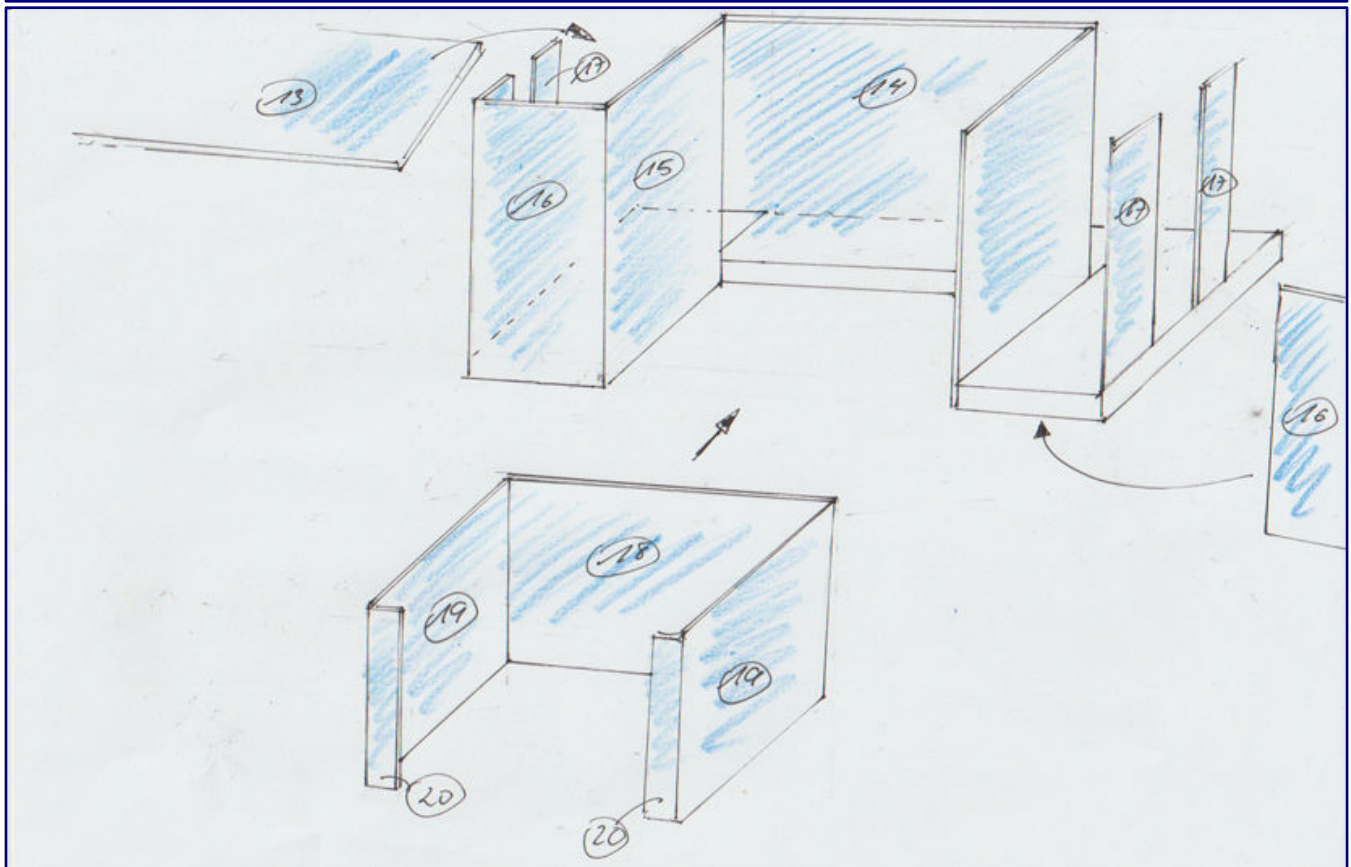
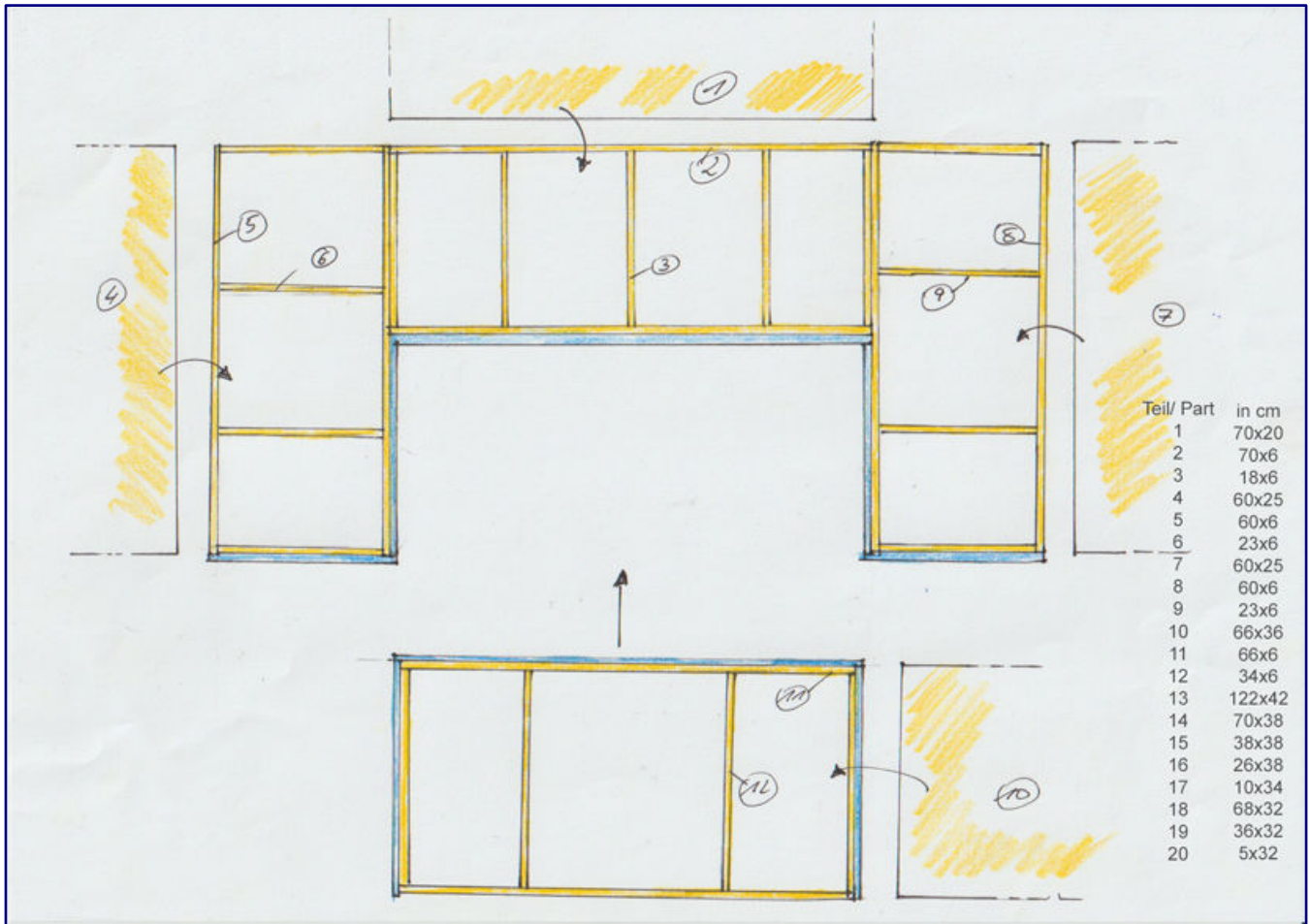

Many results often do not fulfil the final tastes of their builders. Consequently, beginner's mistakes can also be avoided at this point and more appealing results can be achieved with a little thought and planning.

In Part 1 I already recommended a smaller layout for beginners and returners. Now we also want to show the corresponding "railway layout" in its development.

Many readers asked again and again about the current state of an effective presentation in front of spectators. Here, you will find a variation that is very much in vogue. But please, everyone should decide this for themselves!

The basis in this case is of course also the present track plan, which provides the first dimensions. Our showpiece "Upland" will be 66 x 36 cm. in size, taking into account all the desired landscape features. A 6 cm. high box forms its basis.

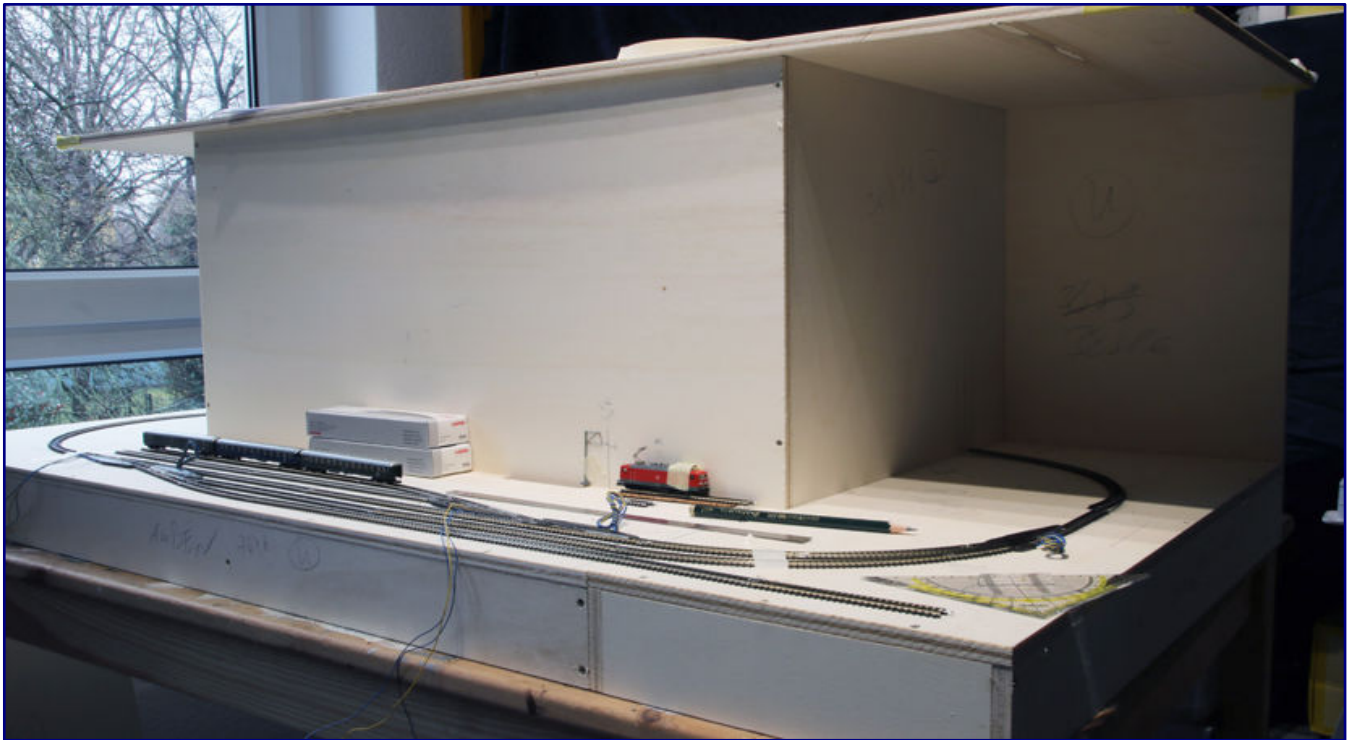

The unfinished box is in place, the first tracks are being laid on a trial basis and even the dimensions of the catenary for later passages are being determined.

With these key data I can now (as always) document the "remainder" in first sketches. Since it is to be a highly modern showpiece, only a "housing system" comes into question. Here, the electrical wiring, luminaries and background scenery are combined in one housing. A clean but scale-independent drawing provides the data for the individual wooden objects (see drawings on page 41).

If the result is satisfactory, a numbered list is used to assemble all the necessary individual parts. In order to save some costs, I create a sawing plan for my carpenter (first sketch and sawing plan see page 43).

continues on page 44

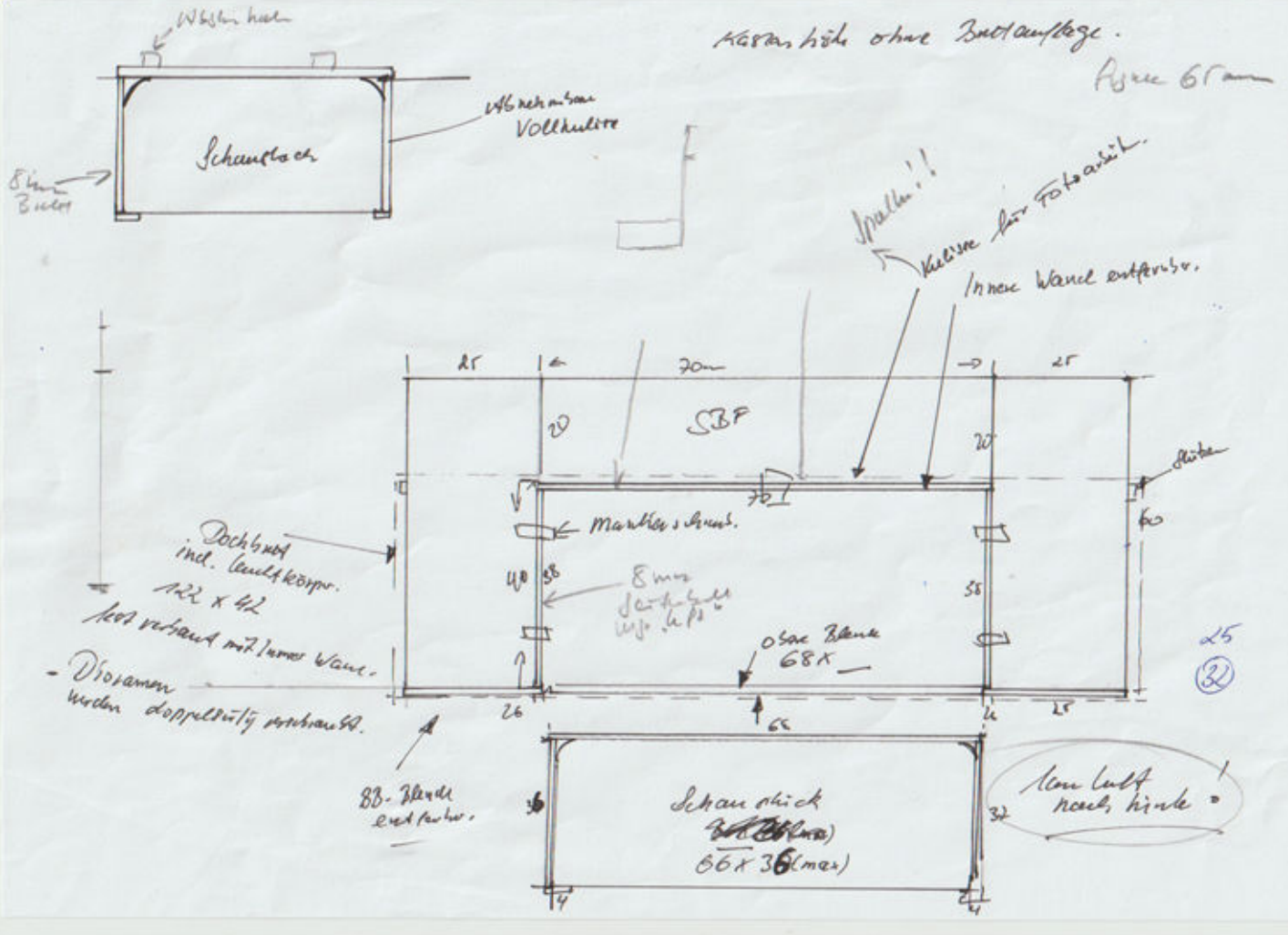

(10mm Poppel) 2500mm x 1700mm
Blatt 1

52x100		52x36		52x36		25x60		1700											
						25x60													
36x66		36x66		36x32		36x32		34x6			38x3 (6x) ▽				38x2 (6x) ▽				
38x38		38x38		38x26		38x26		38x70		38x3		38x3		38x3		38x2		38x2	
6x60		6x60		6x60		6x60		6x70		6x23		6x23		6x23		6x23			
6x70		6x70		6x23		6x23		6x23		6x18		6x18		6x18					
10x28		10x28		10x28		10x28		10x100											
5x40		5x40		5x68		5x100													
6x100		6x100		6x100				6x20		6x20									

A complete board of 10 mm. poplar plywood measures 2,500 mm. x 1,700 mm. as a rule. Please note that the dimensions on my sketches sometimes differ, and should, therefore, only be considered as examples. Thus, even during assembly, deviations from the plan may occur due to new ideas. In this case, a small mitre saw is required as an available tool.

In the case of different types of wood (e.g. beech), I ask my carpenter in advance for the dimensions of a complete board and draw the sawing plan according to the information received. I always take into account the cutting width of the saw blade, because there should be a few centimetres to spare!

I can really recommend that you go to a carpenter's workshop, because the cutting is simply better than in a DIY store. By the way, for insurance reasons, the DIY store (translator: in Germany) is not allowed to cut the wood to a width of less than 10 cm, whereas the carpenter in the specialist workshop is.

After a certain amount of time, the ordered blank cuts are ready and stored in the basement for processing, and sorting is now the order of the day. This takes a few hours.



This is what the box looked like in the summer of 2021, with only landscaping and the electrical installation to follow.

I also usually have leftover wood after cutting, as the carpenter basically sells and saws an entire board. In the further work, all of it is recycled for the landscape work. Larger leftover pieces always serve for the next projects, so nothing is wasted.

I also don't want to hide an important step before assembly. With a 25-mm. Forstner drill, the future cable passages are drilled into the struts. Then, it's finally assembly time.

With various metal angles, wood glue, Spax screws 2.5 x 16 mm. and a cordless screwdriver, it's time to get to work. Allow plenty of time for the wood to find its place at the right angle. The finished construction looks quite simple at first, almost boring.

But the further construction, carried out with sensible steps, comes closer and closer to the objective, and also provides much-needed motivation!

After initially laying out the tracks in the area of the future staging yard, including estimating the dimensions, the next step is to paint them. A 2 mm. thick cork mat serves as an insulating base for my track figures, then the rails are fixed with track nails. Finally, the box is already given its future lighting.



Cable passages and other openings are in place, now the lights will be installed for effective illumination. In the next part, we will get down to the basics of landscaping.

Make sure that the mains voltage connections are always kept separate from the future traction current. If all this has been taken into account and accomplished, you have already achieved a lot. You can look forward to the interim status achieved and part 3 of this series for beginners.

In the September edition we will show you the basic landscape construction and first attempts with the vegetation. From then on, your first work will also have a face and the progress will quickly become visible to outsiders. Until then, please remember: "Good things take time!"

Suppliers for tools and materials:

- <https://www.fohrmann.com>
- <https://www.maerklin.de>
- <https://www.ponal.de>
- <https://www.roco.cc>
- <https://www.uhu.de>

Note for English readers: The literature section that follows is not translated into English because the original texts of the books involved are in the German language. The original German is left here for information purposes only.

Die Geschichte der Baureihe 01

Portrait einer Berühmtheit

Was immer an der Baureihe 01 an Schwächen und Unzulänglichkeiten zu finden wäre, sie ist zweifelslos die Nummer 1 unter den deutschen Schnellzugdampflokomotiven gewesen. Sie war populär wie keine andere und schien lange Zeit überaus präsent, denn ihre Betriebsgeschichte endete erst 1973 bei der DB und 1985 bei der DR. Der EK-Verlag setzt dieser Baureihe nun das noch fehlende Denkmal in würdiger Weise.

Frank Lüdecke / Horst Troche
Die Baureihe 01 – Band 1
Der Star unter den Schnellzug-Dampflokomotiven der Deutschen Reichsbahn-Gesellschaft

EK-Verlag GmbH
Freiburg 2020

Gebundenes Buch
Format 21,0 x 29,7) cm
344 Seiten mit 498 teilweise farbigen Abbildungen

ISBN 978-3-8446-6040-1
Best.-Nr. 6040
Preis 49,90 EUR (Deutschland)

Erhältlich direkt ab Verlag
oder im Fach- und Buchhandel

Null-Eins – zwei Zahlen, mit denen jeder Eisenbahnfreund auf Anhieb etwas anfangen kann! In der Vorstellung taucht sofort die berühmte Schnellzugdampflok mit zwei Meter großen Kuppelrädern auf, die so viele Knaben und junge Männer zu begeistern wusste. Ihre Faszination ist bis heute ungebrochen.

Sie ist die Vorzeigelok der Deutschen Reichsbahn-Gesellschaft gewesen, obwohl sie weder die leistungsstärkste, schnellste oder zahlenmäßig am Stärksten vertretene Lok in ihrem Bestand war. Wie konnte sie sich so dominant und anhaltend im Bewusstsein der Menschen einprägen?

Wir halten also gleich zu Beginn dieser Besprechung erst mal fest, dass ein Baureihenportrait dieser Dampflok mehr als überfällig war, denn sie ist und bleibt für Eisenbahnfreude etwas Besonderes. Dass es so lange gedauert hat, hat aber auch seine Gründe.

Dieses Buch sollte das letzte große Werk von Dipl.-Ing. Horst Troche werden, der sich große Verdienste um die deutsche Eisenbahn und besonders die Dampflok erworben hat. Nach seinem hervorragenden Buch über die leichtere Baureihe 03 wollte er auch ihre große Schwester noch in gleicher Weise würdigen.

Doch daraus wurde nichts. Bevor sein großes Werk fertig wurde, verstarb er. Frank Lüdecke konnte sein Werk nun zu Ende führen und auf seine Manuskripte und Unterlagen zurückgreifen. Er würdigt seinen Vorgänger entsprechend in angemessener Weise als Mitautor.



Auch dieses Buch ist wieder, so lautet das Gesamtfazit, in nahezu perfekter Weise gelungen: umfassend aufgearbeitet, interessant präsentiert mit vielen passenden Fotos bester Wiedergabequalität und dazu auch einige überraschende Informationen. Das tolle Werk wird der historischen Vorlage mehr als gerecht!

Fast 100 Jahre ist es her, als die Baureihe 01 auf die Schienen kam und zusammen mit der 02 die Geschichte der Einheitsdampflok einleitete. Und auch, wenn sie nun fast schon vierzig Jahre abgeschlossen ist, bringen heute zugängliche Quellen noch Neues ans Tageslicht. Frank Lüdecke entwirft daraus im geschichtlichen Kontext gekonnt ein detailliertes Panorama dieser bemerkenswerten Lokomotive.

Werfen wir einen kurzen Blick darauf: Die Vorgaben für die Einheitslokomotiven waren eine deutliche Leistungssteigerung gegenüber Länderbahnmaschinen, ein Vereinheitlichen von Teilen als Beitrag für Rationalisierung und höchste Wirtschaftlichkeit. Anders als bei europäischen Nachbarn ging es nicht um eine reine Leistungsmaximierung.

Untrennbar mit der Einheitslok verbunden bleibt der Name Richard Paul Wagner als deren „Vater“. Viel zu lange hielt er jedoch an den zu Beginn der Zwanziger aufgestellten Grundsätzen fest, auch als sie erkennbar und nachweisbar überholt waren. Dieser Persönlichkeit, weiteren Beteiligten sowie auch dem Nachfolger Friedrich Witte wird ebenfalls ein Abschnitt des Buches gewidmet.

Das hilft beim Einordnen vieler Details und Merkmale, die im Buch beschrieben und hervorgehoben werden. Überraschend ist jedoch zu erfahren, dass die Deutsche Reichsbahn sich Mitte der dreißiger Jahre intensiv mit dem französischen Dampflokbaubau beschäftigte und sogar noch mehrere Maschinen mit Verbrennungskammerkessel und Vierzylinder-Verbundtriebwerk bauen wollte – verhindert allerdings durch den Krieg.

Das sind Facetten, die bislang nicht nachgewiesen werden konnten und anderswo folglich auch nicht zu lesen waren. Sie machen dieses Werk umso wertvoller, weil dies nicht nur die Geschichte der Baureihe 01 betrifft, deren Höhepunkte in den fünfziger Jahren in Ost und West ebenso wenig vergessen werden.

Natürlich fanden auch Bauartänderungen, Modernisierungen und Umbauten wie das Neubekesseln in Ost und West Eingang in diese Fachlektüre. Interessant ist auch ein Kapitel über das Bespannen des Rheingold kurz vor dem Zweiten Weltkrieg, um diesen Zug zu beschleunigen.

Statistiken, Daten über Laufleistungen oder Kohleverbrauch, Bilder von AW-Aufenthalten und die Betriebsdaten der 241 zwischen 1925 und 1938 gebauten oder umgebauten Lokomotiven runden auch dieses hervorragende Buch wieder ab. Auch den 14 erhaltenen Exemplaren (gezählt ohne die 5 Maschinen der Baureihe 01⁵) oder Anekdoten aus dem Betrieb widmet der Autor in angemessener Weise Raum.

Bei all den guten Worten über diesen Band, fragen Sie sich vielleicht, was vielleicht hätte besser gelöst werden können? Und ganz ehrlich, auf diese Frage können wir keine Antwort geben. In Summe ist dieses Portrait nahe an unserer Idealvorstellung dessen, was wir erwarten möchten.

Zu ergänzen bleibt noch, dass der vorliegende Band 1 vor allem die Entstehungsgeschichte mit der Konkurrenz von Vierzylinder-Verbund- und Zweizylinder-Triebwerk behandelt. Versuchsergebnisse und Vergleichsversuche mit Länderbahnlokomotiven werden deshalb ausführlich beleuchtet, ebenso natürlich die Technik dieser Baureihe.

Inzwischen ist auch Band 2 erschienen, den wir ebenfalls rezensieren werden. Dieser widmet sich dem Einsatz bei den Bahnbetriebswerken und weiteren Daten zu den Maschinen, die nicht in den Band 1 gehören. Zusammen ergeben sie das neue Standardwerk über die Baureihe 01, was nach den vielen lobenden Worten sicher kein Geheimnis mehr ist.

.....
Publishing pages with reference possibility:
.....
<https://www.eisenbahn-kurier.de>
<https://www.ekshop.de>
.....

Die schönsten Bahnepochen Wir wünschen allzeit gute Fahrt!

Eine neue Fachzeitschrift für Eisenbahnen zu gründen, darf sicher als ein mutiges Unterfangen bezeichnet werden. Umso mehr hat uns die neue Zeitschrift Eisenbahnklassik neugierig gemacht. Für unsere Leser haben wir einen Blick in die erste Ausgabe geworfen. Nun halten wir fest, was sie bieten kann und will, ebenso aber auch, welche Wünsche an künftige Ausgaben gestellt werden dürfen.

Robin Garn (Hrsg.)
Eisenbahnklassik
Geschichte • Kultur • Fotografie

Nord Süd Express GmbH
Gröbenzell ab 2021

Magazin mit Klebebindung
Format 22,5 x 30,0 cm
100 Seiten mit über 150 teilweise farbigen Abbildungen

ISSN 2748-6427
erscheint quartalsweise
Preis 12,80 EUR (Deutschland)

Erhältlich direkt ab Verlag
oder im Fach- und Bahnhofsbuchhandel

Während wir uns über viele Jahre stets wachsenden Zuspruchs erfreuen durften, kämpften viele Zeitschriften der Printpresse mit ständig zurückgehenden Auflagen. Als Hauptursache wurde ein schrumpfender Markt ausgemacht, in dem der Altersdurchschnitt der Konsumenten immer weiter steigt.

Und auch angesichts eines offenbar eingetretenen Wandels, wie das Hobby Eisen- oder Modellbahn öffentlich wahrgenommen wird, und einem Beleben als Folge der Freiheitsbeschränkungen in Folge der Pandemie bleibt heute noch unklar, wie nachhaltig zuletzt positive Entwicklungen sein werden.

Mitten in der Phase, die wir hier skizzieren, übernahm Geramond im letzten Jahr die Verlagsgruppe Bahn (VGB). Das gesamte Programm kam auf den Prüfstand, wurde auf Wirtschaftlichkeit und Überschneidungen mit Titeln aus dem bereits vorhandenen Portfolio überprüft.

Als Folge wurden einige Zeitschriften eingestellt und einige ihrer bewährten Kernelemente in andere Titel überführt. Ein Opfer dieser Entwicklung war das Magazin Bahnepoche. Geramond-Chefredakteur Michael Hofbauer schrieb dazu jüngst: „(...) es bestand angesichts der Ausrichtung (...) auf eine hochspezialisierte Zielgruppe leider auch keine realistische Chance, es jemals aus den roten Zahlen zu bekommen.“

Mit Robin Garn als Herausgeber hätte sich Geramond jedoch eine weitere Zusammenarbeit gewünscht, doch es sollte anders kommen. Und genau das führt uns zu dieser Titelbesprechung. Wir gehen unbefangen an diese Aufgabe, denn die eingestellte Zeitschrift gehörte nicht zu denen, die wir regelmäßig konsumierten.

Die von Karlheinz Werner und Thomas Hilge – früherer VGB-Verlagsleiter - neu gegründete Nord Süd Express GmbH möchte an eine Tradition anknüpfen und die Lücke im Zeitschriftenmarkt durch einen



eigenen Nachfolger schließen. Dauerhaft gelingen kann dies freilich nur, wenn sich mit den günstigeren Kostenstrukturen eines kleineren Verlags wirtschaftlicher arbeiten lässt und möglichst auch neue und breitere Leserschichten angesprochen werden.

Der Neuankömmling am Fachzeitschriftenmarkt heißt Eisenbahnklassik, bietet dem Leser einhundert Seiten Fachinformationen und soll künftig vierteljährlich erscheinen. Die hier zu besprechende Erstausgabe erschien Ende Juni und soll vertraut wirken, wenn die Vorgängerzeitschrift bekannt ist.

Das neue Magazin soll die Geschichte, Kultur und Fotografie der klassischen Eisenbahn mit Anspruch und Herzblut vereinen. Sachkundige Berichten, Reportagen und Geschichten von Zeitzeugen wollen Autoren und Redaktion ihren Lesern nahebringen.

Als Zeitreise mit unwiederbringlichen Momenten und neuen Erkenntnissen, epochalen Fotos und seltenen Dokumenten metaphorisch umschrieben, waren wir gespannt, was uns erwarten würde. Und der erste Eindruck passt: Die beiden größten Themen des Hefts, die zusammen fast die Hälfte aller Seite füllen, halten das Versprechen.

Aufschlussreiche Rechercheergebnisse, ansprechende und nicht schon hinreichend bekannte Fotografien sowie bislang kaum bekannte Fakten fesseln den Lesern. So war es bislang kaum bekannt, was die Sowjetunion mit den elektrischen Beutelokomotiven aus ihrer Besatzungszone vor hatte und tatsächlich angestellt hat.

Auch das – für den Rezensenten wegen Heimatverkehrsgeschichte besonders interessante – Titelthema über die von Dortmund aus eingesetzte Schnellzugdampflok der Baureihe 03¹⁰ im Zeitraum 1950 – 1958 war bislang eher ein Stiefkind der Eisenbahnliteratur. Über Fahrleistungsrekorde lässt sich nur staunen und endlich bekommen wir einen Eindruck, wie der stahlblaue Lack diesen Maschinen wirklich stand.

Aber das neue Heft hat auch Schwächen, die sich abstellen lassen, schließlich muss es seine Identität erst finden, wobei wir hoffentlich auch helfen können. Schwachpunkte sind auffallend viele Grammatik- und Bezugsfehler, die den Lesefluss stellenweise behindern und den Eindruck erwecken, dass hier mit massivem Zeitdruck gearbeitet werden musste.

Und Abkürzungen kennen im Deutschen per definitionem keinen Plural, weder mit noch ohne ein durch Apostroph abgesetztes s, das es im Übrigen auch in der englischen Sprache nicht gibt und deshalb auch als „Deppenapostroph“ stigmatisiert ist. Überflüssig in einem Eisenbahnmagazin sind auch politische Seitenhiebe („König:innen der Laufleistungen“) zur Gender-Ideologie.

Viele weitere Themen werden in der vorliegenden Ausgabe noch gestreift, die deutlich zeigen, wie breit die Themen und bunt die Facetten der historischen Eisenbahn sind, die eben nicht mehr bei der Dampflok aufhört! Leider kommen viele nicht über maximal eine Doppelseite hinaus und bleiben dadurch sehr an der Oberfläche. Hier sehen wir die Punkte, wo aktuell noch nach der idealen Ausrichtung und eigenen Identität gesucht wird.

Passende Literaturempfehlungen gehören auf jeden Fall hierher, auch die Rubrik „Fahren und Bewahren“ schlägt eine sinnvolle und für uns wünschenswerte Brücke zum heutigen Museumsbahnbetrieb. Und der Blick ins Ausland über ein ReisetHEMA kann ebenfalls bereichern wirken, wenn der Umfang nicht übertrieben wird, was hier übrigens gut gelungen ist.

Sehr gefallen haben uns übrigens historische Aufnahmen vom Bahnbetrieb in Basel (1932 – 1962), der rollende Legenden und Alltagsbetrieb als Fotostrecke präsentiert. Fazit: lesenswert!

.....
: Publishing pages with reference possibility:
: <https://www.nordsuedexpress.de>
: <http://www.eisenbahnklassik.de>
:



Spende und werde ein Teil von uns.
[seenotretter.de](https://www.seenotretter.de)

OHNE
DEINE
SPENDE
GEHT'S
NICHT

Einsatzberichte, Fotos, Videos und
Geschichten von der rauen See erleben:

    [#teamseenotretter](https://www.instagram.com/teamseenotretter)



Spendenfinanziert

Readers' letters and messages

Zetties and Trainini in Dialogue

Thank you for each letter to the editor and all the feedback that reaches us. Write us (contact details are in imprint) - Trainini® lives from dialogue with you! Of course, this also applies to all suppliers in Z gauge, who would like to introduce innovations here. A representative sample is our goal. Likewise, here we note any events or meetings with significance to Z gauge reference, if we are informed in time.

Praise and understanding around the new pages:

First of all, praise for the new Trainini look! You have to get used to everything new, but it occurs very quickly. Also, a big thumbs up for your magazine, which is steadily heading for No. 200, always great, informative, critical, realistic reports and features! Thank you very much!!!

Since you do this, as we do our hobby, free of charge, I wish all the sick people a speedy recovery and everyone else stay healthy and don't get stressed out, we are used to very different delivery times from our main manufacturer.

So first come family, health, career and then the hobby!

Andreas Schärf, by Mail

Good words from another reader:

It is with great regret that I have learned of the serious problems that afflict you all in the context of your great new appearance of Trainini. Whatever the case may be, I hope not all fears come true, and you can soon get back to your dreams and plans with confidence and health in body and soul.

I'm sure many are now waiting for the next issue of Trainini, but for this dedicated team there are probably more important things to do now. I / we are happy to wait! Stay safe!

Dr. Ingo Patschke, by E-Mail

Approval of the page message of 25 June 2021:

I write to express my sincere concerns and best wishes for your current situation and to let you know all of us here in America are quietly awaiting your return with a fantastic monthly publication.

Thank you and return when you are able. We understand. Take good care.

Dwight Landen, by E-Mail



Great understanding from our readership:

When a large profit-oriented toy manufacturer comes up with “fantastic” delivery date lists, it can get on your nerves.

However, if a small organisation like “Trainini” has to postpone the publication dates of its free magazine for personal reasons, then that is acceptable. We can only hope that good wishes for recovery of all concerned will suffice, and that there are no more tragic reasons.

Roland Graesser, Pincourt QC (Canada)

Editor's reply: We were very pleased to receive a wide variety of letters such as the ones mentioned above, which gave us feedback on the understanding and encouragement of our readers. Unfortunately, the situation is and will remain tense, because these are events and strokes of fate that in many respects will continue to have an impact for some time to come in terms of number, severity and timing. The recent flood disaster has also affected parts of our team at least somewhat and made their work more difficult.

Perfectly successful Leig unit:

A long time ago, the report: “Easy (made) express goods train” was presented in issue 5/2010. Using two of the then museum car 2009, a single unit was made from it.

As a concluding remark it was written: “Our Leig unit was created with quite simple means so that the proposal can be replicated by many model railway enthusiasts. As possible refinements for the skilled craftsman remain the addition of a toilet downpipe, the cutting of windows and the reproduction of window crosses as well as doors at the front sides. However, we deliberately leave this to the imagination of our readers.”

Since I was still missing these wagons and four museum wagons were in the showcase, I set about converting this interesting type of wagon into Z. With the help of the Miba freight car volume 1, I had drawings and dimensions at hand, so I could start.

I chose the unit with 8 m axle distance and formed a true-to-scale underframe by courageous cuts. That was the basis. Then, a total of 20 holes were drilled in the car bodies, which then led to the window/door cut-outs using a key file with the patience of a saint.



The toilet window was not forgotten either. The window/door panels/rungs were then created with PS profiles, the rubber beads were created from MS pipe. (There were both bellows and rubber beading!).



Two Leig units of different designs have been produced by our reader after a contribution suggestion from May 2010 on the basis of the museum wagons 2009. The left of the two has additionally received a roof with beading. Both photos: Dirk Rohwerder

On one unit, the roof beading was also reproduced as a variant and covered with a wafer-thin layer. The distinctive lettering was printed on a decal using an inkjet printer.

After this work was finished, the cars got a patina, the windows were glazed, and one car got end windows. After that the double units were firmly coupled. This tinkering project was really fun, now the express goods train can do its rounds.

Dirk Rohwerder, Sprockhövel

Former dealer and small series manufacturer deceased:

Already on 19 April 2021 Dipl.-Ing. Wilfried Schmidt from Hameln passed away at the age of 79. Under his former company name "Spur-Z-Partner Schmidt," he also took part in the International Spur-Z meetings in Geseke and Altenbeken, as well as in many trade fairs until his retirement.

Long-time model railway enthusiasts will still know him as a model railway dealer, small series distributor, and also small series manufacturer. Michael Bahls, who is well known today, also began his professional career there, before he also started his own business as a small series manufacturer.

With Dipl.-Ing. Wilfried Schmidt, the Z gauge community loses a deserving and committed member of its early days, who was able to give much input and also contributed to the fact that its scene could develop in a colourful and versatile way. Our condolences go to his wife Herta and all other relatives.

New magazine for role model friends:

"Where do railway enthusiasts feel at home? Certainly not between barren noise barriers and overgrown tracks of a railway that stops operating because there are leaves on the track or a switch is frozen."



Cover image: Nord Süd Express

This is how the young publishing house Nord Süd Express (<https://www.nordsuedexpress.de>) from Gröbenzell introduces a short presentation of its new magazine Eisenbahnklassik (Railway Classics), which we also present in a review in this issue.

So it turns back the clock according to its own understanding and wants to make a big promise to its readers: more classic railways, more information from the great times of rail transport than in any other magazine.

Anyone who is interested in the great era of the railway, when different types of traction were still on the road side by side, and the railway became an engine of the economic miracle, is in the right place. According to the publisher, the magazine sees itself as innovative.

The content focuses on the history, photography and culture of 20th-century German railways, but also includes information on today's operators of nostalgic and museum railways as well as other "preservers" of historical relics of rail transport. In future, expert reports, major features and short stories will alternate on 100 pages each.

Change of Management Board at the Spielwarenmesse:

On 1 July 2021, following the retirement of board members

Ernst Kick (chair) and Dr Hans-Juergen Richter, a new management trio took over with Florian Hess, Jens Pflüger, and Christian Ulrich (spokesperson).

All three are very familiar with their areas of operation. In addition to the joint management of the company and the supervision of subsidiaries and participations, the tasks are clearly structured: Florian Hess acts as Board Member for Fair Management, Jens Pflüger is responsible for finance, human resources and information technology, and Christian Ulrich, in addition to his role as spokesperson, is in charge of marketing and public relations.

Märklin new deliveries in July:

Six new items arrived at the dealers in the last few weeks. Among them is the six-piece container wagon set (item no. 82665), a very interesting set for the early Era V, which combines the familiar photo from Bundesbahn times with the beginning age of privatised railways.

It consists of two Sgs 693 carrying wagons and four two-axle Lgjs 598 for combined freight traffic. They transport various 20- and 40-foot shipping containers as well as tank containers. Striking and well-known designs of TFG (Bundesbahn), Hapag-Lloyd or Maersk, still combined with the addition "Sealand," clearly point to the period of operation.

The two double-decker car transport wagons DDm of the ÖBB with patch in pure orange (87095) belong to epoch IV and were also found across borders. They always ran in passenger trains and were not to be found in goods trains, as their classification as luggage wagons already makes clear. They can also be combined with Bundesbahn rolling stock without any problems.



ÖBB's DDM car transport wagons in pure orange also travelled across borders and can thus also be lined up with German passenger coaches without any problems, for example.

The blue-grey paint scheme of the Deutsche Reichsbahn is worn by the express train locomotive E 18 053 (88083), which many friends of Era II will have long awaited. Converted to bell armature drive and illuminated with warm white LEDs depending on the direction of travel, it has become a technically contemporary model.

A Bundesbahn classic in a modern guise is SGL's grey V 270.09 (88205) for Era VI. The former V 2001 of the Bundesbahn is in this design the Nuremberg Fair special model 2021, which unfortunately had to do without its usual exhibition frame.

Further new product deliveries are the annual wagon 2021 for the Märklin magazine (80831), which takes the four-axle self-unloading wagon with hinged cover Tad-u 961 of the DB as a model and the sliding wall wagon Hbbins of the SBB in advertising design of Tela-Kimberly (82385), which is on the road in epoch VI.

Flood Donations via Joswood:

The Bergisch accessories supplier Joswood (<https://lasercut-shop.de>), itself located in the middle of one of the severely affected flood areas, has started a fundraising campaign to benefit institutions that have suffered flood damage or are helping flood victims.

The handicraft business is grateful to have come through this catastrophe without any damage itself and now wants to show solidarity with those who were not so lucky. The recipients are still being selected and will be announced later.

For ten days from 18 July 2021, Joswood intends to donate 50% of its turnover generated during this period to the aforementioned causes. Owner Jörg Schmidt announces this in a video at the following address: <https://youtu.be/TkQ4Ynsa-c4>.

Zetties who want to participate here with a purchase are reminded of our report in **Trainini®** 4/2021, in which we presented wooden overseas boxes of this manufacturer and effectively staged them on Märklin SSy 45 heavy-duty wagons. The good response from our readers strengthens us in the view that friends of our scale can also provide good assistance here.

Loading scene of the Bundeswehr:

Inspired by the latest new products we have presented here, as well as reports and hints from our readers Hartmut Schnittjer (**Trainini®** 5/2021) and Christian Liebau (**Trainini®** 6/2021), we have produced a loading scene of Bundeswehr tanks at a loading ramp, as close to the prototype, as possible.

The heavy goods vehicles SSy 45 (art. no. 82229) and SSym 46 (82352) from Märklin were used, as well as a Leopard 1A1 tank from Z-Panzer, soldiers from a "Accessories Air Force personell" figure pack from Herpa (551663) and the new MAN AE Cargo Bundeswehr (MAN 630 AE; 322.032) from Artitec.



With the help of Märklin heavy-duty wagons, as well as accessories from Artitec, Herpa, and Z-Panzer, a Bundeswehr loading scene in late Era III was created, as further inspiration for our readers.

This scene could be supplemented by other tank and Unimog models from the aforementioned manufacturer, olive green painted vehicles such as the VW Transporter or also the MAN 630 from Ratimo-Z in the three design variations offered.

Shorty-Models of USA classics:

In Japan, which is plagued by a lack of space, so-called shorty models in all common scales are a big hit. This often trivialised and always shortened rolling stock allows many model railway enthusiasts to present their hobby in the home environment. Furthermore, children often feel very attracted to it.

Some years ago, Rokuhan expanded its product line in Z gauge accordingly. After several Japanese models, the US EMD F7 is now the inspiration for the entry into the North American, but also the European market as an A and B unit. Initially, versions of the Santa Fa (Item No. ST012-1) and New York Central (ST012-2) are available.

At Noch, they will certainly be added to the sales programme in the near future. Ex-works, they are painted and printed bodies on a unpowered chassis. To set the models in motion, powered and motorless chassis are already available separately in the Rokuhan range.

We have been told that, if the market is successful enough, matching carriages and conversions based on European models are also planned.

Faller new products available:

Faller is celebrating its 75th anniversary this year, because Edwin and Hermann Faller began in 1946 with the creation of the first construction kits and finished models of the accessories range. The most important new products for Z gauge can, therefore, also be regarded as an anniversary model, because



The recently delivered Oberneulander Mühle (item no. 282789), a gallery Dutchman, is more or less Faller's anniversary model for Z gauge to mark its 75th anniversary, as it is completely in the founding tradition of appealing functional models. Photo: Faller

it is something special in terms of size and function and is very much in the tradition of the company founders.

The Dutch windmill with an octagonal ground plan (art. no. 282789) consisting of 213 solid-coloured hardboard parts in seven colours has now arrived in the shops. Like the prototype, it has a surrounding gallery with railings, which distinguishes it from the so-called smaller earthen windmills.

The functional model is based on the listed "Oberneulander Mühle" in the Bremen district of the same name. With the separately available Faller gear motor (180722), the blades can be set in motion.

Since the design of the mill bonnet (cap), which deviates from the original, caused criticism, we are still planning a construction report including motorisation. In this context we would like to look for solutions on how to bring this part closer to the prototype, without losing its movement functions.

In view of the situation that has already been communicated, however, we assume that we will not be able to fulfil this plan until the 2022 vintage. Since, it is questionable how long the kits will be available, interested parties should stock up early in order to be able to build our proposal in good time.

MTL continues wagon series:

Micro-Trains continues the delivery of the Sweet Liquid series with wagon number 5. The latest model in this series is the light grey example of a 39-foot tank car discontinued by GATX with inscriptions from Domino Sugar (Item No. 530 00 530).

The company to which it is dedicated is now the largest sugar manufacturer in the United States of America.

Micro-Trains products are distributed, among others, by Case-Hobbies (<http://case-hobbies.de>).

Tank and car models, also for Z gauge:

The Dutch supplier Panzer-Shop.nl specialises in tank models and army vehicles in scales of 1:160 and 1:120. However, they also offer interesting vehicles for Z gauge, ranging from the time before the Second World War to the present day, all of which are 3D printed conversions.



The latest offshoot of the Sweet Liquid series is this "Domino Sugar" tank car (Item No. 530 00 530). Photo: Micro-Trains



Ford V3000 (left) and Mercedes-Benz L4500 (right) are two of the vehicles offered by Panzer-Shop.nl for Z gauge, in this case for Era II, and, as war surviving examples, for early Era III. Photos: Panzer-Shop.nl

Sorted by country, individual vehicles can of course appear twice in the range if they are in service with different NATO partners. Construction site vehicles, such as a Caterpillar track excavator or a wheeled loader (earth mover), are particularly interesting.

Civilian commercial vehicles can also be found in the assortment at <https://www.panzer-shop.nl>. The site is available in four languages, in order to be able to obtain information and order easily.

Four new products from AZL in July:

New at American Z Line in July is the EMD F7 as a combination of A and B unit of the Erie Lackawanna (item no. 63012-1). It is complemented by a single A-unit (63012-2). The mighty-looking EMD E7 also rolls in as an A and B unit and now wears the colours of the Missouri Pacific (64615-1 / -2).

The R-70-20 refrigerator cars now pull up in a bright orange Milwaukee Road livery and can be purchased as singles (914811-1), twos (914841-1) and fours (904811-1).



EMD F7A and -B (part no. 63012-1; photo left) of the Erie Lackawanna and EMD E7A and -B (64615-1; photo right) of the Missouri Pacific. Photos: AZL / Ztrack

Also available in the same configurations are the 1917 8,000-gallon boiler cars that belonged to California Dispatch (915008-1 / 915038-1 / 905008-1).

Manufacturer photos of the current deliveries can be found at <https://www.americanzline.com>.



Showcase in the Faller-Miniaturwelten with a selection of different product lines from its 75-year history.

Faller-Miniaturwelten is open again:

What today are the miniature worlds of Faller, as a company museum has a long and special tradition in Gütenbach: everything goes back to a model room, that for a long time was reserved only for business partners.

At times, it was also used to give presents to the children of employees at Christmas time - an event that was certainly very popular with the youngest and gave rise to career aspirations. Today, this room has become a modern company museum that vividly illustrates the 75-year history of the company.

Since the week of 28 June 2021, the Faller-Miniaturwelten (Miniature World) and the factory shop have been reopened. As a little surprise, the garden railway has been redesigned. Admission is free.

Opening hours are Wednesday to Friday from 11:00 – 16:00 and on Saturdays from 11:00 - 15:00. However, as the building is not barrier-free, visitors with limited mobility are requested to call (0 77 23) 6 51-114, in advance.

A new project from Ukraine:

Our reader Alexey Mark introduced us to a new project that he was able to complete after more than a year of work. He felt there was a lack of buildings and facilities based on industrial models, and this led him to the future theme of a wind turbine.

Sustainability should obviously also be expressed in the model world, and, so, he set to work. The first model was Faller's wind turbine for N gauge, but the drive motor was not placed in the base, but where the generator is located in the prototype.

The search for a suitable motor with sufficiently small installation dimensions and slow but equally smooth running proved difficult.

In terms of the template, the choice fell on the widely used E-82 model from Enercon. Its pylons have a height of 59 to 138 metres, depending on the location, and the rotor diameter is 82 metres. It thus generates an electrical output of between 2,000 and 3,000 kW.



A view of the generator with the self-printed sliding pictures for labelling and the attached element for the functioning beacons. Photo: Zmodell / Alexey Mark

The model height of 59 m should prove to be ideal for the model and so it was time to construct and print the necessary parts using grey coloured resin. It was difficult to find suitable templates for all the necessary views, especially the view from above. The following model dimensions resulted:

- Pylon height 24 cm.
- Rotor diameter 19 cm.
- Total height with rotor blade vertically upwards 33,5 cm.

continues on page 62



Additionally, a flashing electronic of the Hungarian manufacturer Trainmodules (<http://www.trainmodules.com>), and a down converter to control two beacons were used to make the wind turbine visible for aircraft.

Their parts were placed inside the column, the red LEDs (SMD type 0402) are placed in prototypical holders. In the future, however, the use of an in-house developed holder is planned.

Refined with applied etched parts, the assembled object was finally ready for painting with Tamiya colours in various mixing grades. Extensive and repeated masking was part of the necessary preparations. Base colour was LP-35 "Insignia white".



Several masking operations, colour tinting and painting were necessary to bring the mast base in colour to the original. The access door to the mast, which is necessary for maintenance and repair work, was not forgotten. On page 61 the completed and electrically driven wind turbine can be seen in full. Photo (also page 61): Zmodell / Alexey Mark

The rings on the mast were tinted from various shades of green from the Tamiya range. Other colours such as aluminium and red were also used. Alexey also made the necessary decals for self labelling on a Mimaki UV printer.

Finally, the completed wind turbine was screwed onto a circular base plate of 10 cm. diameter, connected, and the small plate was landscaped to present it effectively. Its rotation speed is set to twelve per minute, which is the average of the prototype rotation (6 - 18 revolutions/minute).

If our readers are interested in this development, they can contact us by e-mail ([zmodell\[at\]ukr.net](mailto:zmodell[at]ukr.net)) or through social networks (<https://www.facebook.com/Zmodelltrains/>).

Quietly continues with NoBa models:

After three weeks of relaxing holidays on the boat, things are a little quieter at NoBa-Modelle (<https://www.noba-modelle.de>) than we have been used to in recent months. Nevertheless, the creative duo has presented some extremely interesting new products.



Two versions of the bus Büssing BS 110 V (item no. 6379RF; photo above) and the tram T2 (5706R; photo below) as a still unpainted model. Photos: NoBa-Modelle

With the Büssing BS 110 V bus, another important model for Era III is now available. It is available as a moving model (item no. 6379R / 6379RF), and with open doors at the stop (6380R / 6380RF), each as a resin print blank and as a finished model.

For fans of street car themes, a catenary measuring car (5707R) and a rail grinding car (5708R) of the SBB are now in the programme. Meanwhile, the programme has been extended by the two-axle railcar T2 (5706R), and a motorised finished model of the already known articulated railcar GT4 (5703RF).

As a preview for the next few weeks, NoBa-Modelle has named a maize chopper that will be seen again in the fields of Europe in about two months.

New model at WDW Full Throttle:

At FullThrottle (<http://www.wdwfullthrottle.com>) a new model of the bulk goods wagons with cylindrical container is on offer. Painted bright yellow is the example posted under ACFX with advertising slogan "Old Dutch Cleanser" (item no. FT-1042-3).



Cylindrical Hopper "Old Dutch Cleanser" (art. no. FT-1042-3; photo left) and of the C&O/CSX (FTPZ-8022-1; photo right). Photos: WDW Full Throttle

Also released in June was the black 100-ton bulk freight hopper wagon with three discharge chutes and outside box struts (FTPZ-8022-1) of the CSX or C&O. Both of the above-mentioned wagons are delivered in double packs with different service numbers.

DDR roll-off container new at Schrax:

A roll-off container for the W50, a typical truck of the former GDR, has been available for H0 scale for some time. Now, it is also available from Schrax (<https://www.schrax.com>) in Z gauge.

With a cable winch, its prototype was pulled onto or off the transport vehicle via lowered telescopic rails. After the fall of the Wall, both these containers and their transport vehicles quickly disappeared from the traffic scene in the east of the Republic.

Voting for the EM diorama competition is underway:

It's the turn of the readers' jury, the editorial team of the railway magazine announces. Among the 39 exhibition layouts submitted for the adult category, there are also three works for Z gauge. In the youth category (ten participants), unfortunately no one took part this time in the smallest scale.

We are thrilled by the 15 x 30 cm. dioramas shown in a magazine insert and we are sure to recognise the handwriting of at least two of the three participants. Of course, we will not reveal them so as not to call into question the neutrality of the votes.

However, we hope that the members of our scale community will also participate actively in the voting and help to put our representatives in a good position. The following works are competing for the 1:220 scale:

- E03 "Timber loading" (removal of storm-damaged timber on the Ilztal railway after the winter of 2018).
- E17 "Loading ramp in Z" (lovingly designed loading road and ramp with locksmith's shop and forge)
- E20 "Raiffeisen Warehouse" (scenically designed agricultural warehouse with truck ramp and track).

Many attractive prizes will be raffled among the participants of the voting: three shopping vouchers of different traders worth between 250 and 500 EUR, wagon models, accessories, books and calendars.

Votes can be cast in writing using the voting coupon in the supplement of the 8/2021 railway magazine or electronically at <https://eisenbahnmagazin.de>. The deadline is 31 August 2021. Each reader may cast three votes in the adult category and one in the youth category.

Imprint

ISSN 2512-8035

Bibliographic information of the German National Library: The German National Library lists this publication in the German National Bibliography. Detailed bibliographical data and editions can be found in the DNB catalogue at <https://portal.dnb.de>.

The publication of **Trainini Praxismagazin für Spurweite Z** is voluntary and non-commercial. **Trainini German Magazine for Z Gauge** does not aim for any sources of income. This publication is governed exclusively by German law.

Contributions marked by name exclusively reflect the personal opinion of the author. This is not necessarily the same as that of the editor or publisher. Unless otherwise indicated, photos are taken by the editor.

Board of Editors:
Holger Späing (Editor-in-Chief)
Dirk Kuhlmann
Joachim Ritter

Correspondent North America:
Robert J. Kluz

English translation:
Alexander Hock, Christoph Maier, Martin Stercken

Further voluntary work: Stephan Fuchs, Torsten Schubert

Licensed **Trainini Discussion Group** (<https://www.facebook.com/groups/1597746057122056/>): Michael Etz (**Trainini Locomotive Doctor**)

Publisher and V.i.S.d.P. is Holger Späing, Am Rondell 119, 44319 Dortmund; Contact: 49 (0)231 9598 7867 or by e-mail to [redaktion\[at\]trainini.de](mailto:redaktion[at]trainini.de).

Advertisements of events and advertisements of third parties are free of charge, but will only be accepted after availability and recognisable track Z reference. They appear separately from the editorial part on the sole responsibility of the advertiser. Advertisements from small series providers always have priority.

Letters to the editor must be submitted in writing by post or e-mail to [leserbriefe\[at\]trainini.de](mailto:leserbriefe[at]trainini.de), stating the full name and address of the responsible reader, and are always welcome. Publication is reserved to the editorial staff. The editorial team always endeavours to present a representative picture and therefore to take every submission into account.

By submitting pictures, photos and drawings, the sender agrees to the publication and indemnifies the publisher against any possible claims by third parties. This expressly includes a future repetition in the magazine, annual video as well as in brochures and posters.

All company names, trademarks and designations mentioned in this publication belong to the respective manufacturers or rights owners. Their reproduction takes place without guarantee of the free usability. For misprints, errors, price quotations, product descriptions, building specifications or transmission errors of any form whatsoever, the editorial staff and publisher assume no liability.

Trainini Praxismagazin für Spurweite Z is published monthly (without guarantee) and is available to all interested model railroaders, especially friends of gauge Z, to download free of charge and for a limited time from <https://www.trainini.eu>. Downloading may incur third-party connection and network service provider costs. The placement of only the complete magazine on other domains is expressly permitted after it is no longer available on **Trainini**'s own pages, and as long as the download is not offered for a fee.

All contributions, photos and reports are subject to copyright. Translation, commercial printing and any other form of reproduction, even in part, require the prior express consent of the publisher. Unauthorized commercial use will not be tolerated.

Trainini® is a legally protected trademark, registered in the register of the German Patent and Trademark Office (Munich), No. 307 30 512. The trademark is owned by Holger Späing, Dortmund. Misuse will not be tolerated. All rights reserved.