

International Edition

Free,
electronic magazine
for railroad enthusiasts
in the scale 1:220
and Prototype

www.trainini.eu

Published monthly
no guarantee

ISSN 2512-8035

Trainini

German Magazine for Z Gauge



The V 200⁰ of the first construction lot

Starting digital control
Maintenance & care

Introduction

Dear Readers,

October also brought us many warm days, and the foliage of our trees was more colourful than usual in our latitudes.

But nothing can mislead us. The hobby season has long since begun and Christmas is not even that far away anymore. So Rita Kruse-Spiekermann's tree construction article in this issue is a perfect fit, because it is dedicated to the production of spruce using copper wire.



Holger Späing
Editor-in-chief

But also our rolling stock often requires some attention and needs to be cleaned and maintained. This is certainly one of the preparations for the time when we tend to be intensively involved with model railways.

Therefore, after a longer break, we have again launched a new segment of our "Maintenance and Service" series. We have arrived now at the seventh segment, after this series began five years ago.

Our contributions to basic digital knowledge are not so numerous yet, but they will appear at much shorter intervals as being the focus of the year 2018. Today we are digitizing a locomotive model for the first time in order to finally be able to begin operations on our test oval.

And I may already disclose that we will not run out of ideas so quickly! That is also due to your large interest, because its reception as well as requests and suggestions show us, where knowledge is still required. Seldom has a topic engaged our readership in such a way as it is the case with digital operations explained in detail for beginners.

As editors, we are happy about this together with our authors and helpers. Even though the vast majority of people in the Z scale are still using analogue technology, there is a strong interest in the possibilities of the digital world.

However, the current product range should not be neglected. In the last quarter of a year, deliveries (not only) at Märklin increase rapidly and we can always present many new models in the magazine. This is also what we are doing this time in the notifications at the end of this issue.

We would like to and will dedicate ourselves more intensively to some of them. This time it is the freshly delivered V 200 in its original version. There is already a model with this characteristic, but only for club members. So what is the difference compared to this exclusive model? We have reviewed this model and pointed out the differences between the sisters.

Also on behalf of my colleagues, I hope that you have once again found an interesting and multi-faceted issue. If you enjoy reading it and find new things to expand your knowledge, then I hope we have done a good job. Let us know that in the future as well!

Yours,

Holger Späing

Editorial

Introduction	2
--------------------	---

Model

The same but different	4
------------------------------	---

Prototype

Currently no items

Design

Realistic looking conifers	14
----------------------------------	----

Technology

Commissioning of a digital locomotive	22
A puzzle game with many pieces	35

Literature (not translated - only in German)

Egghead story(s)	45
The course book route 224c/284	47

News

Zetties and Trainini in Dialogue.....	50
---------------------------------------	----

Imprint.....	64
--------------	----

We thank Rita Kruse-Spiekermann for her contribution including photographs.

Date of publication of the German language version of this issue: 24 October 2018

Cover photo:

V 200 052 is still in its prime when it crosses the striking viaduct with its long-distance express train. On the hook is one of the famous representatives of the blue F-train system, which is already made up of the modern new passenger cars of Group 63.

The class V 200⁰ of Märklin The same but different

The V 200⁰ is a model railway classic across all gauges and sizes. Therefore a model in scale 1:220 was foreseeable. Märklin initially served the members of its customer club with the 81175 and 81176 train sets. In 2018, the Göppingen company will be offering an Epoch III variant for the first time in its regular catalogue programme. We have taken a closer look at this and answer the question whether it is also worth buying for owners of the two previous versions.

The happiness was high when Märklin announced the 81175 train pack, the first model of the "Wirtschaftswunderlok" (economic miracle locomotive) V 200⁰. Together with the passenger coaches a local train appeared here, as was typical for many years in the metropolitan area of the Hanseatic City Hamburg. The logo known as "DB biscuit" was already emblazoned on the sides of the locomotive designed for the kidney table era.

With the F train "Blauer Enzian" the next version followed, again from Epoch III. In contrast to her sister, which was on the tracks from around 1964, it was at home in the late fifties and represented the original configuration for this series. This also included the "DEUTSCHE BUNDESBAHN" on the sides of the locomotive.



V 200 014 originates from the first construction lot and was manufactured by MaK. In September 1962, the D 93 "Bavaria" travelled to Munich near Harbatzhofen in the Allgäu region to appear in front of the photographer's lens, it had already lost its sublime lettering "DEUTSCHE BUNDESBAHN". Photo: Heinz Hangarter, Collection of Eisenbahnstiftung

Under article number 88203, Märklin announced another Era III version with the same lettering for the 2018 Toy Fair and recently put it alongside its sisters. For the first time since its original appearance, all customers now have access to the original version of this popular series.

But doesn't this thwart the exclusivity of the Insider special series? We answer this with an emphatic “no” and would like to prove this point of view in the following by comparing the models that have appeared so far. In fact, as we will show, the locomotives are different siblings.

Characteristics of the role models

In order to arrive at this conclusion, we will first make a brief effort to recall the model history of the V 200⁰. In 1953, the Munich locomotive factory Krauss-Maffei supplied five locomotives with the operating numbers V 200 001 to 005. Their design language, in keeping with the spirit of the times, and the paint finish in RAL 3004 purple red and RAL 7021 black grey, separated by aluminium trim strips that converged to form a “V” at the ends, was also adopted for the series machines.

Some details such as the horn hidden behind small openings above the lights (instead of a whistle in front of the driver's cab), the shape of the lamps, an additional third peak light, the smaller engine room windows or the roof design, which was influenced by the fans, changed. At the same time, the performance of the engines was increased from a total of 2,000 to 2,200 hp.



On 14 September 1958, V 200 013 had not been in service for two years. Accordingly, it appears in front of the Zurich - Wilhelmshaven express train near Frankfurt-Bonames in its as delivered condition. This includes the “V” on the front curvature of a MaK locomotive, which is wider (see also photo on page 6), which made the locomotive appear much bulkier than its KM sisters. Photo: Brian Bittner, Sammlung Eisenbahnstiftung

After testing, the Bundesbahn initially ordered 50 locomotives of this series, 20 of them from Maschinenbau Kiel (MaK) and 30 from Krauss-Maffei (KM), which were put into service in 1956/57. In 1959 a further 31 machines were ordered, all of which were manufactured by KM (see also the report in **Trainini®** 4/2012).

We previously described the unchanged colour scheme using the example of the preproduction machines, only the protective coating of the roof in RAL 9006 white aluminium remains to be added here. While the locomotives of the 2nd construction order already carried the “DB-Keks” on the sides ex-works,



The V 200 048 from Krauss-Maffei's first delivered series also presents itself to the photographer in the delivery condition with a raised lettering. The smaller radius "V" of the decorative strips has a much more elegant appearance and therefore became the standard for this series. In the picture, she departs across the Hohenzollern Bridge on 11 September 1960 with an express train and travelling to Köln-Deutz station. Photo: W. A. Reed, Collection of Eisenbahnstiftung

all of the first order production were still provided with the raised aluminium letters explained in the beginning.

Since there was a stronger tendency for rust formation in these areas, the lettering soon disappeared and was changed to glued-on logos, as appear on the model in the 81175 package.

A distinguishing feature of the machines of the first construction lot according to their manufacturers was the guidance of the white-aluminium-coloured decorative strips in the front area: the shape of the "V" was flatter in MaK (V 200 006 to 025), i.e. designed in a larger radius, while the narrower curve in KM (V 200 026 to 055) led to a more pronounced and also more elegant point.

V 200 056 to 086 were identical in this point, because they also originated from KM production, but already had a DB logo on the long sides ex-works. The other 50 series locomotives adapted this design from the middle of the sixties. In addition, the locomotives of the second lot differed from their predecessors by larger front flaps.

For most of the locomotives, this also included removing the trim strips and attaching painted decorative lines, all of which were based on the Krauss-Maffei line layout. The larger curve, as conceived by MaK, therefore, only was used for a short time.

After a new colour scheme was introduced in 1974, the V 200⁰, now known as the 220 series, was no exception. Since the striking "V" was now dispensed with on the locomotive ends, the diesel locomotive lost its elegance and appeared thereafter quite bulky. Luckily, with 220 012-9, 220 023-6 and 220 060-8, only three units were painted in ocean blue ivory colours (RAL 5020 / RAL 1014).

With regard to the history of the locomotive series, it should be briefly noted that the V 200⁰ was often overtaxed by the increasing train loads, which led to damage to the engines and transmissions, especially in the early years of service.

This became known as the “V 200 crisis”. The Deutsche Bundesbahn reacted to this by ordering 50 units of the performance-enhanced V 200¹ (from 1968: class 221), which entered service between 1962 and 1965.

Optical comparison of the models

The most recently delivered 220 012-9 (Art. No. 88202) is the only model to have been labelled for Era IV to date and is one of the few examples in the 1974 colour scheme.

Both DB models from the exclusive Insider series, on the other hand, belong to Era III and reflect the delivery condition (88176) or the appearance in the mid-sixties (81175). Common to both implementations, however, was that they came from the first production run of MaK and were produced with the attached trim strips.



With article number 88203, Märklin is offering the first original version of a Bundesbahn V 200⁰ in its standard program. Its prototype comes from the production run of Krauss-Maffei for the first series.

They are therefore unmistakably wearing the “V,” which converges in a larger arc at the point, and by which the 20 examples produced by this manufacturer could easily be recognized from far away, as they appeared much bulkier.

With the newly delivered V 200 052 (88203), other customers now have access for the first time to a model of the popular series in its original colour. As with the “Blauer Enzian” locomotive, this is a replica of its as delivered condition.

On the sides, the blue, round factory plate of Krauss-Maffei already shows where this model originates. It is to be expected that the front part of the shield will also show clear differences in the ornamental lines to those of its two MaK sisters.

But with the comparison of this new product (88203) with the MaK locomotive (from 81176), there is disillusionment in this point, contrary to expectations: The fronts look absolutely identical, except for the different company numbers. Unfortunately, Märklin made a mistake here, which we have already pointed out to the manufacturer. This is surprising because a similar mistake did not occur in H0 scale.

Continues on page 9





In comparison to the more rounded V 200⁰ (front), the nose of the successor V 200¹ (rear), which has a more sharply sloped nose, is also noticeable in the model.

Comparison photos on page 8:

V 200 020 (picture above, left) comes from MaK's delivery lot and correctly carries "wider swingarms", while the decorative trim on V 200 052 (picture above, right), a Krauss-Maffei specimen, should be more pointed. Unfortunately, Märklin made a very visible prototype mistake here, as the comparison of the same model (picture below) with the V 200 150 (Art.-No. 88201) shows. The performance-improved successor series came completely from the Munich factory buildings and was identical in this characteristic with its older sisters.



The round factory plate under the Bundesbahn logo unmistakably assigns V 200 052 to the manufacturer KM. According to the addresses it is assigned to Bw Villingen in the BD Karlsruhe, the date of delivery is 30.4.57.

In order to give our readers an understanding of the differences, we have also put its sister V 200 150 (88201) beside the V 200 052.

This version, built in 1965, also came from Krauss-Maffei and therefore also shows the lines that we would have expected in Märklin's new product.

Their differences consist of round lamps instead of oval ones and a steeper front, which of course also influences the optical impression a little.

The tiny size of the Z model also conceals the error somewhat.



This time Märklin has succeeded very well with the mould separating edge on the sides of the rounding, which is now hardly recognizable in comparison to the V 200 020 (left, from art. no. 81176). Also compared to the V 200 150 (picture on page 8 below), which is already well done in this respect, further progress can be seen here.

Nevertheless, it becomes clear what the V 200 052 should look like when viewed from the front.

Fortunately, we can report that Märklin is now checking whether a correction is still possible for the second batch of the series. So maybe there will soon be two variants of this article number and Zetties that are strictly oriented to the prototype would still get their money's worth.

Another positive point to emphasize is that Märklin apparently reworked the mould or has otherwise adjusted its production methods recently. The shape separating edge, which was previously quite clearly visible on the side edges, is barely visible now.

Märklin deserves praise here, because after the ocean blue ivory coloured 220 012-9 (88202), the latest edition of the already older models of the successor series 221 has now been updated. What has remained is the very clear reproduction of the machine room printed identically on both sides.

Technology under the hood

While the first editions of the V 200 were launched with the classic five-pole motors, both the 88202 and 88203 models benefit from a chassis modification. The previous motors have now been replaced by the bell-shaped armature motor, which works through the same gearboxes.

As with other bogie models, the printed circuit board has given way to a two-part version in the course of model improvements. For the digital supplier Velmo, this means a great challenge, because its previous solutions will no longer fit. However, we are confident that a digital solution for interested customers will follow in this case, as well.

In terms of driving characteristics, however, this would not be necessary at all. Like the 221 series, the 220, which is based on the same chassis, has always been one of the models that runs well and are also recommended for use at trade fairs.



A bell-shaped armature drive with flywheel mass works under the housing of the model to ensure smooth running. This is not only good for reducing background noise, but also for the slow driving characteristics. For the retooling of the drive, however, the circuit board had to be split, as with the model 88202.

However, the conversion to the new motor is welcomed against the background that the low-speed operating characteristics have further and noticeably improved with it. In addition, all the locomotives that have been retrofitted, so far, now run considerably quieter than before. This is also quite noticeable, and opens up additional prospects wherever a Velmo sound decoder could be accommodated, and we are not explicitly referring to the locomotive being discussed here.

Otherwise there is not much more to say about the new model: from the beginning the models of the V 200⁰ were equipped with light emitting diodes. All previous versions benefit without exception from a warm white and clearly visible three-light headlight signal as well as two red tail lights on the opposite end. This is certainly more appropriate, because in the original the V 200⁰ could be operated from either end.

Especially in the greater Hamburg area, this feature was used with quite extensively. The only thing missing from the model is a Hasten box, i.e. a Silberling control car of the original design, or a middle entry car with a control compartment of the same basic design.

Prototypical use

This brings us to our final observation. How can the V 200 052 be used as a prototype? It was designed as a multi-purpose locomotive for medium-heavy service. As a paired locomotive and as a symbol of the economic miracle, however, it was used only sparingly in its early years of service before freight trains.

Instead, it hauled high-performance express trains on all important main lines, above all the blue F trains, which were still the highest quality type of train at the time. However, the model lacks the modern passenger coaches of Group 54 with the large revolving doors, which began to displace the old coaches from the F train service in the mid-fifties.



Creativity is required when creating blue F trains with the V 200, as many of the car designs required for this are missing from the Z-gauge range. For example, we used the passenger coaches of the 8135 Dompfeil package and placed a single A4üm with folding doors directly behind the locomotive. This wagon is only a compromise for a missing one of type group 54, as it was only in service in sufficient numbers in the mid-sixties.

This shortage also exists in the area of ordinary D trains. Here the same new cars would be necessary, partly still filled up by “Hechte” or their welded steel construction successors. Märklin only has the skirted cars which were still used in such services at that time, in its programme.

So compromises are necessary in the model. If you want to use your V 200 in F-train service, you cannot avoid borrowing passenger cars from the former Dompfeil pack (8135) or the Loreley Express (87351). Märklin's new cars, which have been on the market in various versions since 1972, belong to the UIC type X with folding doors and were not on the rails in their original prototype until around 1963.

But by then the V 200 was already slowly withdrawing from high-quality passenger service because the progressive track electrification was displacing it from many routes. This meant that these machines were now increasingly being used for local passenger service and for freight trains.

This part of the operating time can be easily modelled on a scale of 1:220. The range of wagons is sufficiently large with regard to various suitable types. For the 220 012-9 (88202) Märklin has specially designed a Heckeneilzug (87549) consisting only of 2nd class cars.



The V 200⁰ was also used in freight train traffic. For this reason, we have assembled a colourful mixed freight train for you, in front of which the V 200⁰ makes a good impression.

Suitable alternatives for Era IV would also be the 87339 and 87400 wagon packs. Anyone who wants to cover a late Era III D train with the V 200, on the other hand, would go for the single wagons 87101, 87112, 87121 and 87131. Silverlings were also considered to be high quality at that time and could be found in this train type.

Fast goods trains offer an almost limitless selection. Almost anything with wheels can be selected here. There are also no restrictions for the individual types of car as long as no heavy ore train is formed.

The focus should be on new DB cars that were approved for significantly higher speeds, than those taken from Reichsbahn stock. This is very much in line with the V 200, which was approved for a maximum speed of 140 km/h.

In view of the popularity of the model, we believe that more of its sister models can be expected in the near future. This is especially true for the old red paint finish, which was used until the end. Era IV has not yet been addressed by Märklin. Even so, the V 200 is finally approaching significance in this small scale.

Manufacturer pages and dealer directory:
<https://www.maerklin.de>

Making spruce trees from wire Realistic looking conifers

Rita Kruse-Spiekermann's previous tutorials on modelling trees were very well received by our readers. Today she gives, therefore, additional advice on making conifers, using spruce trees as an example. After all, conifers are often considered to be amongst the most difficult greenery items to model in a convincing fashion.

By Rita Kruse-Spiekermann. In order to complete the picture, let us now add a chapter on modelling spruces to our small series on making model trees. After all, whilst we can rarely do without conifers on our layouts, making them poses particular challenges.

Let's start by twisting some tree trunks again today. Because of the long drying times it is recommended to make a batch of several spruce trees at the same time. The wire should be sufficiently strong to support the following steps.



Making realistic looking conifers can be a particularly difficult modelling challenge. Part of the solution lies in individually designed wire armatures for the trees.

As with any other wire trees, we begin by twisting a bunch of wires into the lower section of the trunk of our conifer. We then bend some of the wire sideways into the first branches. This step continues several times: twist the trunk, bend off branches, twist the trunk, etc. Each bent wire becomes a new branch. Once done, we shorten the branches with scissors and leave a nicely looking top of the tree!

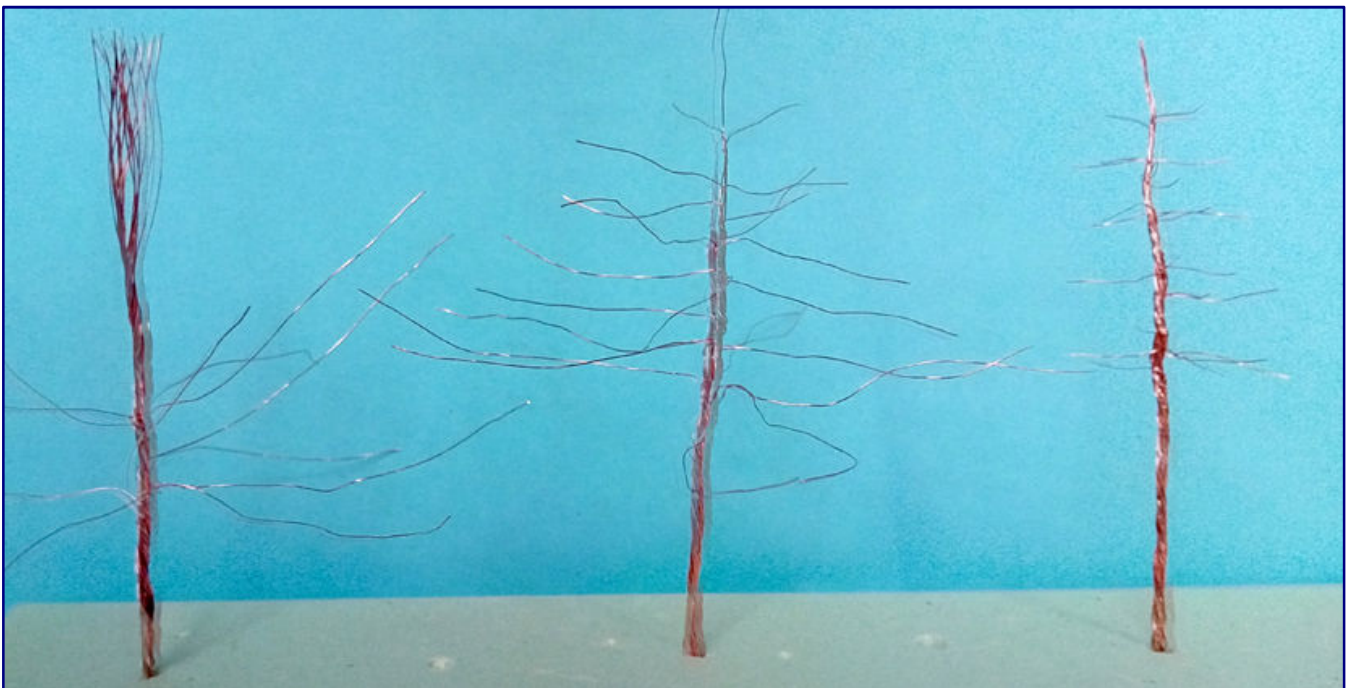
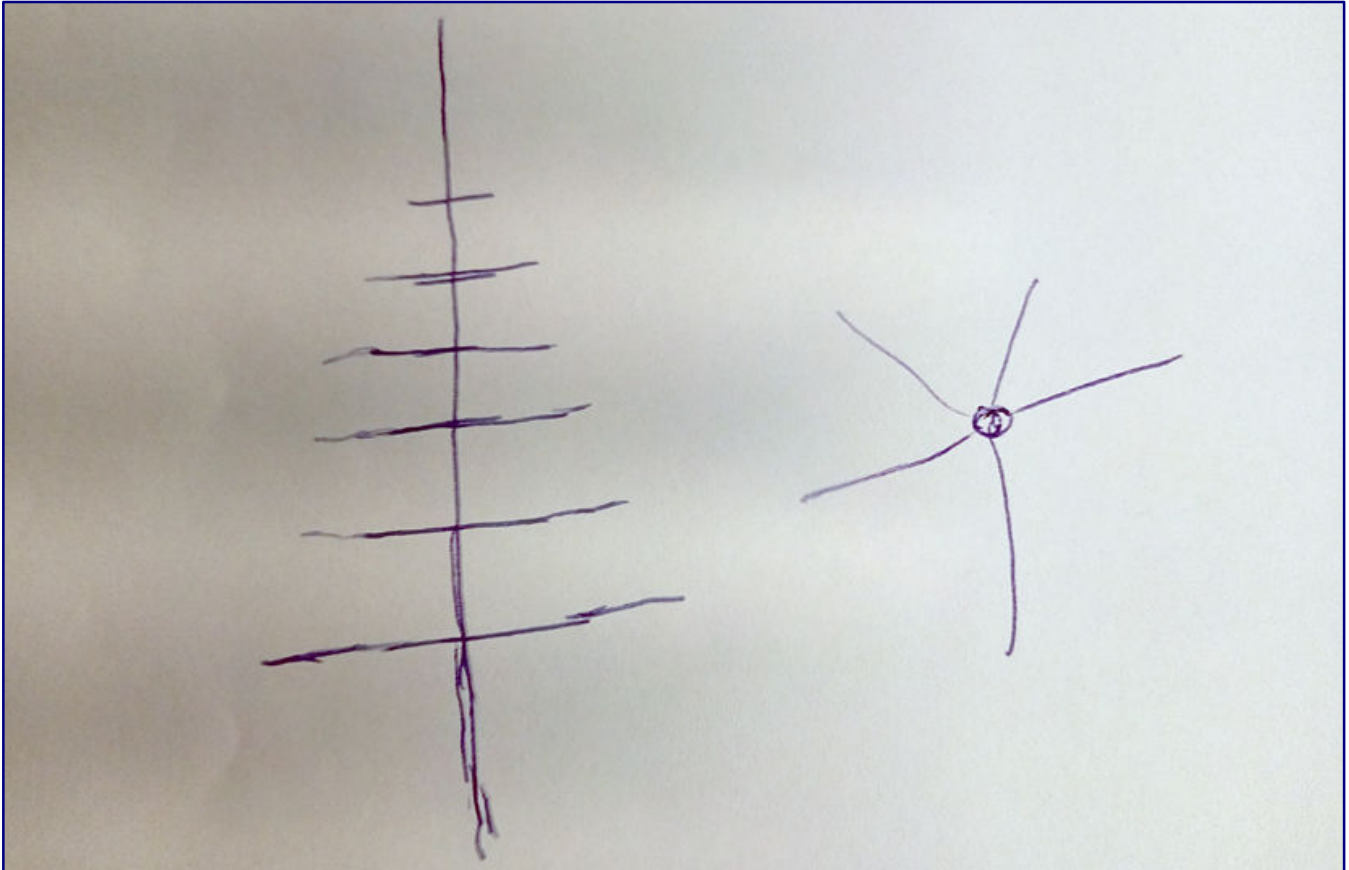

A little drawing (photo top) illustrates how the wire branches should look from the side (left) and the top (right). The wire armatures are bent into shape accordingly (photo bottom).

We now continue with the coating of the wire armature. With a brush we apply glue and sprinkle a mixture of sand and sawdust over it. By the way, for spruces, I use more sand than saw dust, as this gives the surface of the trunk a finer texture.

In the next step, we paint the spruces with tinting colours. Brushing on browns, greens, ochres, and whites, we will try to create a realistic looking bark. The best way to find out what it should look like is to take an attentive walk through the woods — you will find that nature does not do monochrome black trunks. We now let the trunks dry and can still rework them later, if needed.



One important step of the modelling process consists of achieving a realistic looking trunk: The bark consists of a mixture of fine sand and saw dust which is sprinkled onto the glue covered wire armature. Once sufficiently dry, the bark is painted with several shades of tinting colours. The photo shows several states of completion. Consulting photos of real trees helps to assess the result.

As for greening the spruces, I used the spruce material from Mininatur (article numbers 973-26 and 973-22 G). The instructions provided with this product did not work, however, for me.

Further tree building articles by the author:
Rita Kruse-Spiekermann has already described twice in our magazine how to make and design trees by building them herself.
These articles can be found in **Trainini®** 9/2017 und 3/2018, in the licensed archives.

I therefore proceeded as follows: A piece of foliage sheet was cut somewhat diagonally to the direction of the threads of the foliage web and then plucked into small pieces. Following that, I applied some glue with the help of a toothpick on the left sides of the branches and attached a piece of foliage to each.

The reason for first gluing foliage bits to all the left sides of the branches before doing the right sides was that otherwise I would have quickly lost my orientation. If several spruces are glued at the same time, everything can dry at the same time.

Cont. on page 21

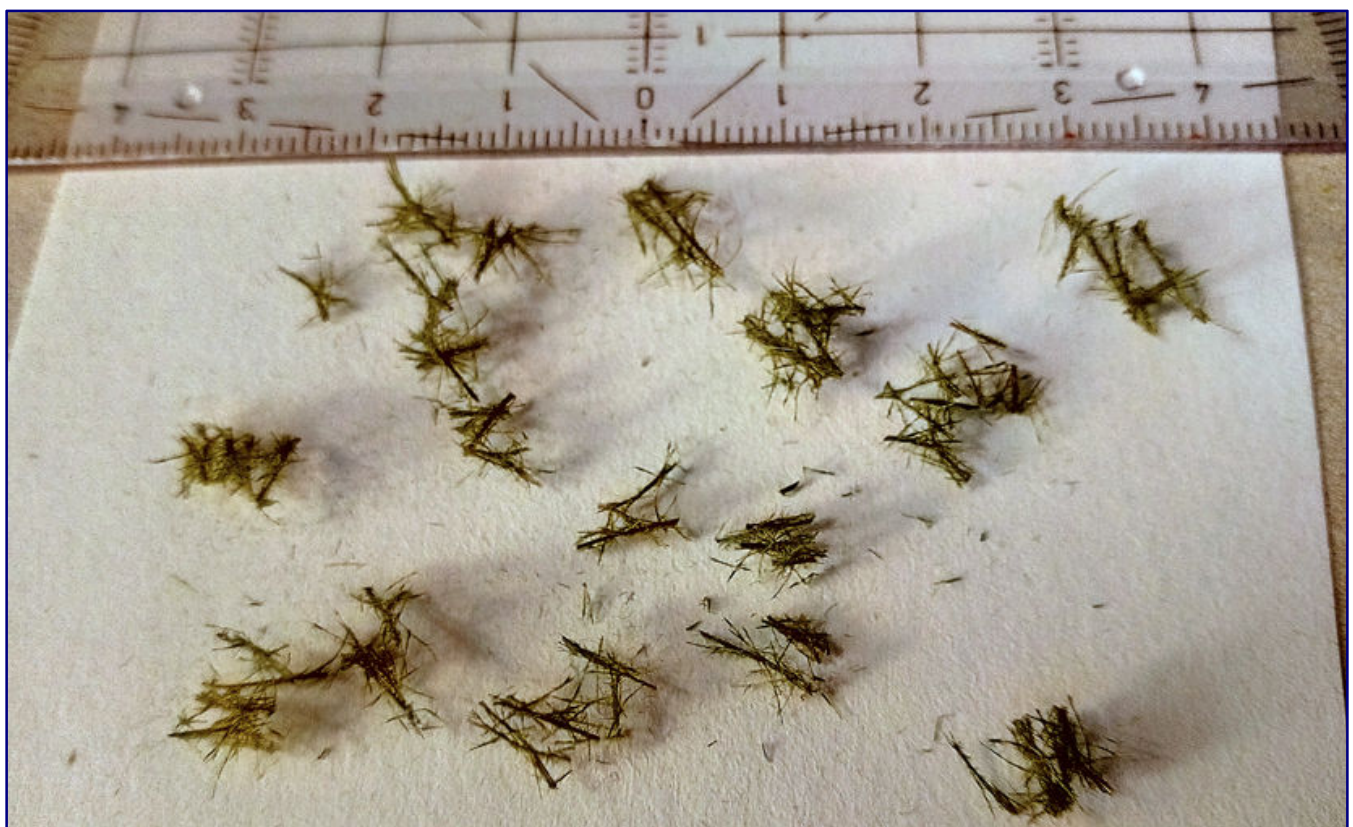



In order to give my forests a more authentic look, I always also prepare some trunks without branches. These can then be cut and used to model a pile of cut timber. Just don't forget to paint the cut surfaces with a light colour! Short pieces of trunk also serve as perfect tree stumps, because without them logged timber probably would not make sense in our forest.



Some additional wire armatures have been prepared, some with, some without branches. Once finished, they will serve as tree stumps and cut timber in the spruce forest.

Photo series on the two preceding two pages:

Page 17 top – For this project we used two types of spruce tree foliage from Mininatur (Silhouette): “Weathered” and “Summer” (Article numbers 973-26 and 973-22 G). The foliage should be cut diagonally to the threads of the foliage web.

Page 17 bottom – The resulting foliage pieces should have a length of a little less than 1 cm.

Page 18 top – With a tooth pick we apply just a little bit of glue to the left side of each branch before attaching the foliage pieces. We then do the same for the right side of the branches. Doing one side first before the other helps to keep seeing the forest for the trees!

Page 18 bottom – It is best to work on several trees simultaneously, in order to save time. Step by step, our spruces grow from bottom to top and start taking a realistic looking shape.

So, regardless of whether you start your tree-making project with a walk in the woods or by jumping straight to the modelling phase, have fun in the spruce forest!

All photos (including page 20): Rita Kruse-Spiekermann



It is not only the self-made spruces that make up the realistic impression, although they undoubtedly account for the largest proportion of the forest's exemplary effect. Not to be neglected, however, is the forest soil, which is not overgrown or only in light areas, the plywood and stumps of former conifers which were broken off by a storm.

Manufacturer pages and sources of supply:

<https://www.mininatur.de/en/>

Adhesives for model making:

<http://www.uhu.com/en/home.html>

Faszination Modellbau

Internationale Leitmesse für
Modellbahnen und Modellbau

1.- 4. November 2018

**MESSE
FRIEDRICHSHAFEN**



Der beliebteste und spektakulärste
Event für alle Modellbauer in Europa!

Öffnungszeiten:

Do. bis Sa. 9.00-18.00 Uhr, So. 9.00-17.00 Uhr

www.faszination-modellbau.de

facebook.com/Faszination.Modellbau

instagram.com/faszination.modellbau

youtu.be/39AKUYOv0M4



35. INTERNATIONALE
MODELLBAHN AUSSTELLUNG



15.-18. NOV. 2018

EIN TICKET 4 EVENTS!

KOELNMESSE

www.MODELLBAHN-und-LEGO.de

Zeitgleich: 10. Kölner



Ticket auch gültig für:
LEGO® Fanwelt
LEGO® Kidsfest
16.-18. NOVEMBER



Öffnungszeiten IMA:

Do. bis Sa. 9.00-18.00 Uhr, So. 9.00-17.00 Uhr

facebook.com/InternationaleModellbahnAusstellung

youtu.be/xHxYqfk9HbE

Showtime!
QR-Code scannen oder Youtube-Link
eingeben für das neue IMA Video:



LEGO, das LEGO Logo und die Minifigur sind Marken der LEGO Gruppe. ©2018 The LEGO Group.

Digital model railway control (part 5)

Commissioning of a digital locomotive

Our test facility is fully wired and equipped, and train operation could begin immediately. What is still missing is a digitized locomotive. Our author Andreas Hagendorf takes care of it in the fifth part of our current series.

By Andreas Hagendorf. What happened so far: The test circuit is set up; the tracks are wired and electrically tested. Now all that is missing is digitised rolling stock in the form of a locomotive, then everything can be put into operation together with the control centre and the digital fun can begin.

Also, for Z gauge there are some suitable small locomotive decoders on the market. Many are standard products with solder points or also cables, which require more or less deep technical knowledge and skill from the user during installation.



Today we want to start the digital driving fun on our layout. Before the first test drives on the test oval, the 218 217-8 must first be digitized with a Velmo decoder. In the following we show how this works.

The Velmo decoders, on the other hand, are tailor-made for the respective locomotive models and are simply exchanged with the original analogue locomotive board. This has the advantage of not requiring changes to the locomotive undercarriage, as could be the case with soldering or milling.

So even for less experienced hobbyists the conversion is done in a few minutes, especially because of the detailed and illustrated installation instructions, for which digital beginners will be most appreciative. The digitized locomotive can also be converted back to an analogue model at any time and without any problems.

The disadvantage is that due to this system, replacement decoders are only available from this supplier for models which have printed circuit boards. Many diesel and electric locomotives are included, as well as a few multiple units, but unfortunately no steam locomotives. The complete, available program can be found on the website of Velmo. Also the 1zu220-Shop offers these decoders, as their distributor.



As an example we will today upgrade the 218 217-8 from Märklin (Art.-No. 8880) with a Velmo exchange decoder for digital operation.

If there is enough space under the locomotive housing for a loudspeaker, you can even find a decoder with sound effects in the delivery programme. A Z gauge diesel locomotive, like the famous “Ludmilla” with engine and other sounds, is always an attention getter at exhibitions and opens viewers' eyes.

All Velmo decoders use the components of Doehler and Haass and therefore offer their extensive functionality. These include multi-protocol capability with DCC, SX1 and SX2, load control SSD (“Super Soft Drive”), diode and ABC brakes as well as an update option without exchanging the decoder.

Selection of the locomotive

For our test facility, we will first digitize a model from the popular 218 series. We chose the purple red ivory coloured 218 217-8 (Märklin 8880). For this locomotive there are two decoder variants in the Velmo range: the type LDS27000 and the “professional version” LDS27000-P.

The first type uses the cables in the roof of the locomotive housing to connect the LEDs of the original lighting. This makes it possible, among other things, to change the light from white to red, depending on the direction of travel, but not to switch off the rear lighting on the side of the driver's cab facing the train in a prototypical manner.

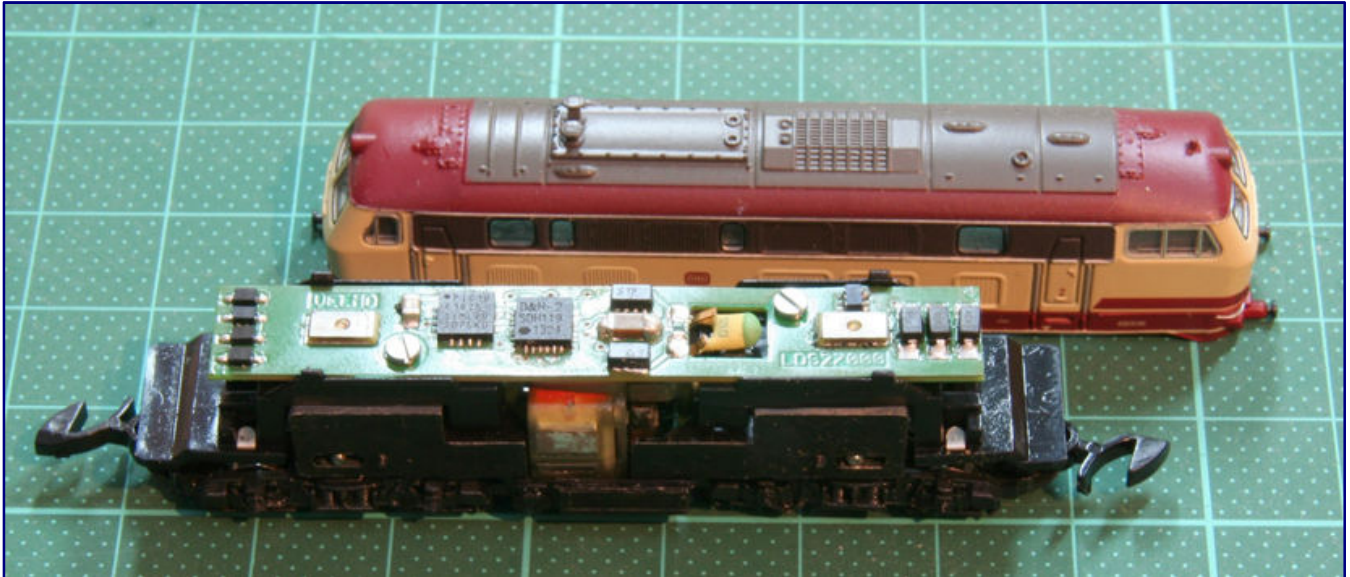

Here 218 217-8 is equipped with the locomotive decoder LDS27000 from Velmo. It uses the original contact in the roof of the housing and therefore has the restrictions described in the text for the lighting functions.

This in turn is made possible by the type with the additional identification "-P", but in contrast to the principle mentioned above, changes to the locomotive are necessary in this case:

The cables in the roof of the locomotive housing have to be removed, and a dismantling would therefore be required together with higher costs and soldering work. This also results in the designation as a professional version.

No matter what type, they always come in environmentally friendly cardboard packaging with printed installation instructions.



The decoder itself and the necessary small screws are sealed in an ESD bag that protects against static discharge. The decoder should remain in this packaging until shortly before installation.

The configuration instructions can be downloaded from the Velmo website. This is also useful and environmentally friendly, as this manual is more comprehensive and covers several decoder types at the same time.

Preparing the analogue locomotive

Before a locomotive is digitized, it should be cleaned as described in the corresponding Märklin instructions, lubricated and operated in analogue for testing.

Factory new locomotives should also be run in for a while before the conversion is begun. The following applies: An analogue locomotive that runs poorly (in analogue) may not run as well or not at all digitally.



After removing the housing, the analogue locomotive appears as shown in this picture: The printed circuit board is held in place by four lugs and a screw (left).

Our series 218 was therefore been cleaned and is ready for digitalisation. After removing the locomotive housing, the analogue circuit board was easily accessible.

The black screw (see arrow in the picture on page 26 above) must be unscrewed, and then the circuit board can be removed. There are four small lugs on the locomotive undercarriage which hold the printed circuit board in place. This resistance can be overcome with slight pressure.

In addition, we must also unscrew one of the screws that become visible after removing the PCB (see arrow in the picture on page 26 below). The three dismantled parts must be stored safely together.

Installation of the locomotive decoder

Before we start and remove the locomotive decoder from its protective cover, it is advisable to dissipate the static charge that may have built up in your body. To do this, we simply touch a radiator or a heating pipe, as these parts are earthed via the house installation.

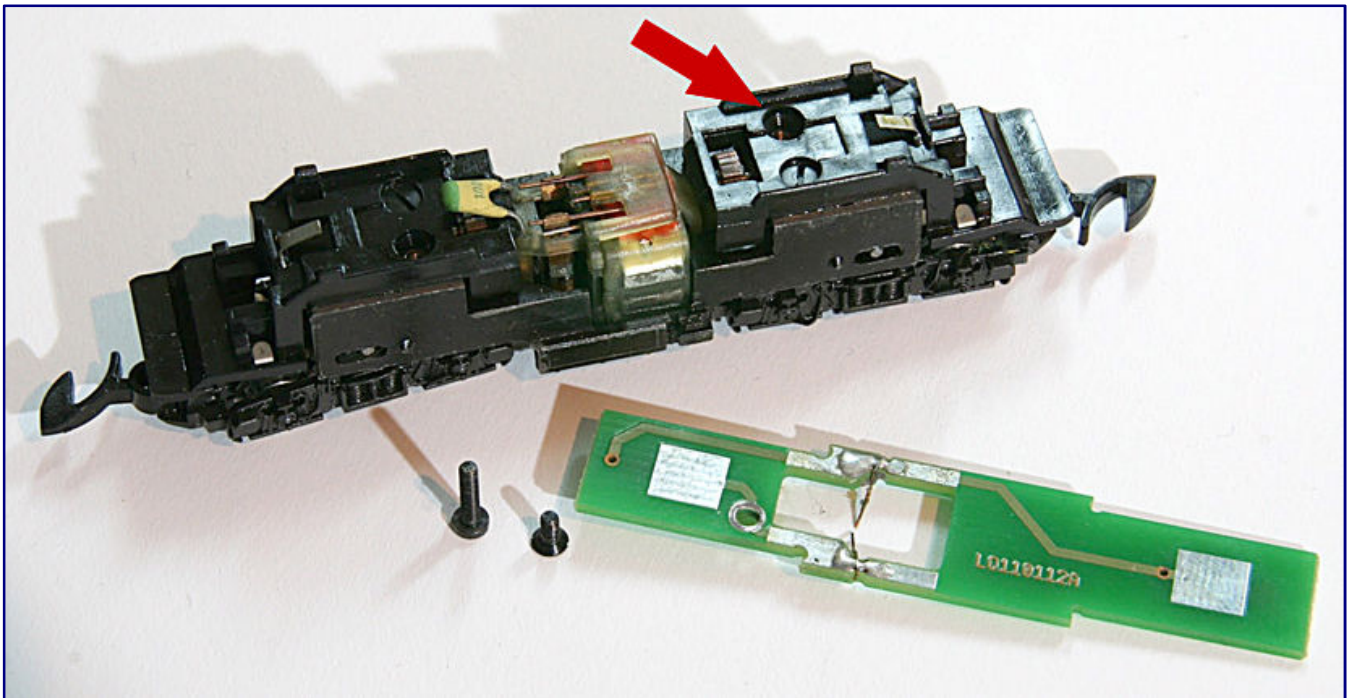

To loosen the analogue circuit board, loosen the first screw (photo above; arrow). After removing the screw, also unscrew the screw on the opposite side (photo below; arrow), which was hidden underneath.

Only then should we remove the locomotive decoder and the two small screws from the ESD bag.

The decoder is inserted in its place in the locomotive undercarriage. The interference capacitor of the locomotive must be located in the cut-out of the printed circuit board. The position of the motor connection wires is also important. They must touch the connections of the interference suppression capacitor to the motor.

However, they must not touch any part of the locomotive undercarriage or each other (short circuit). It may be necessary to adjust with a fine screwdriver.

Then we should check to determine that the interference suppression capacitor is still properly positioned and does not touch the motor pinion below it. This would be noticeable afterwards during the test drive by the resulting noise.

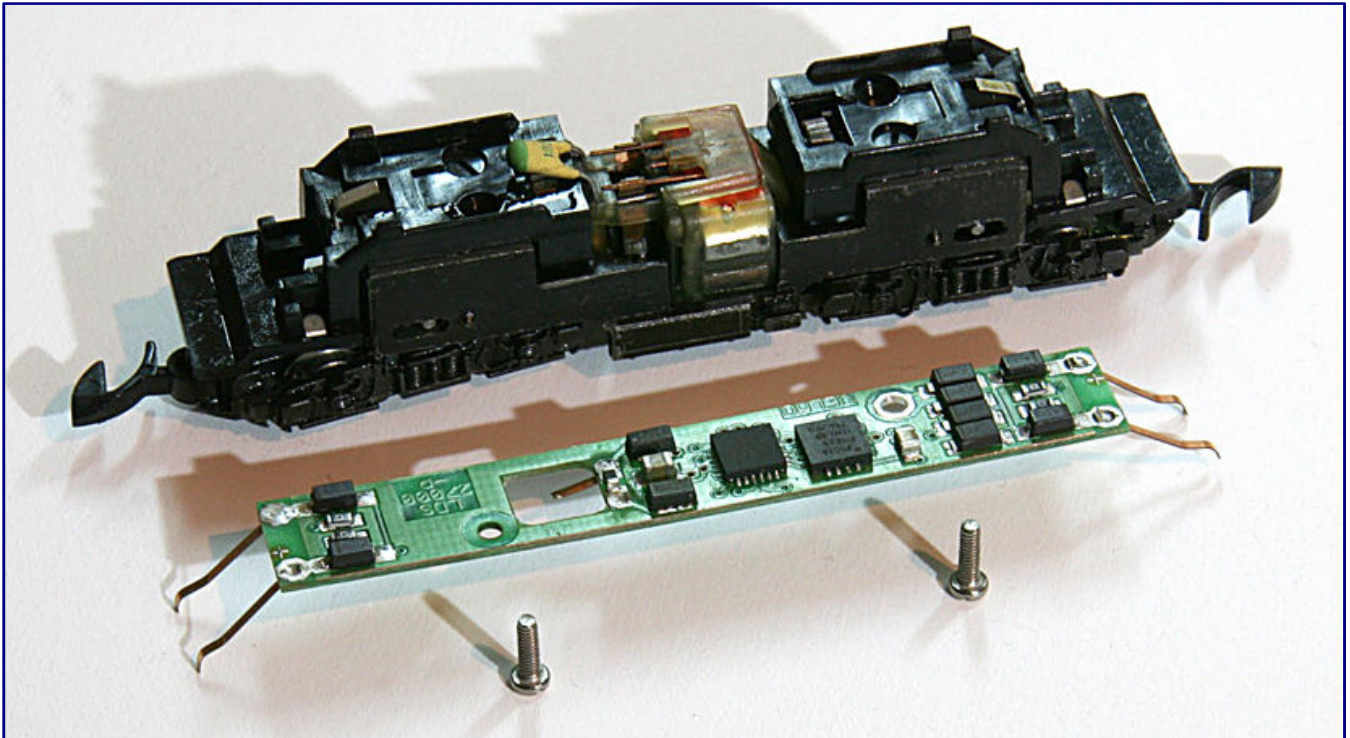

The Velmo locomotive decoder can be seen here in its installation direction with its supplied mounting screws. The opening in the printed circuit board is intended to provide space for the capacitor and the access for changing the brushes, when required.

If everything meets our satisfaction, the decoder is attached through the holes in the printed circuit board to the locomotive undercarriage using the screws provided.

With the decoder version "-P", the four wires in the housing cover must be completely removed from the contacts to the LED boards.

To do this, we cut the wires flush with the solder joints. The contact springs are hot caulked in the roof; they therefore remain where they are ex-works.

We will also keep the wires together with the other removed parts.

While not necessary, but to pacify our "electrical conscience" we have covered the remaining contact springs with insulating tape.

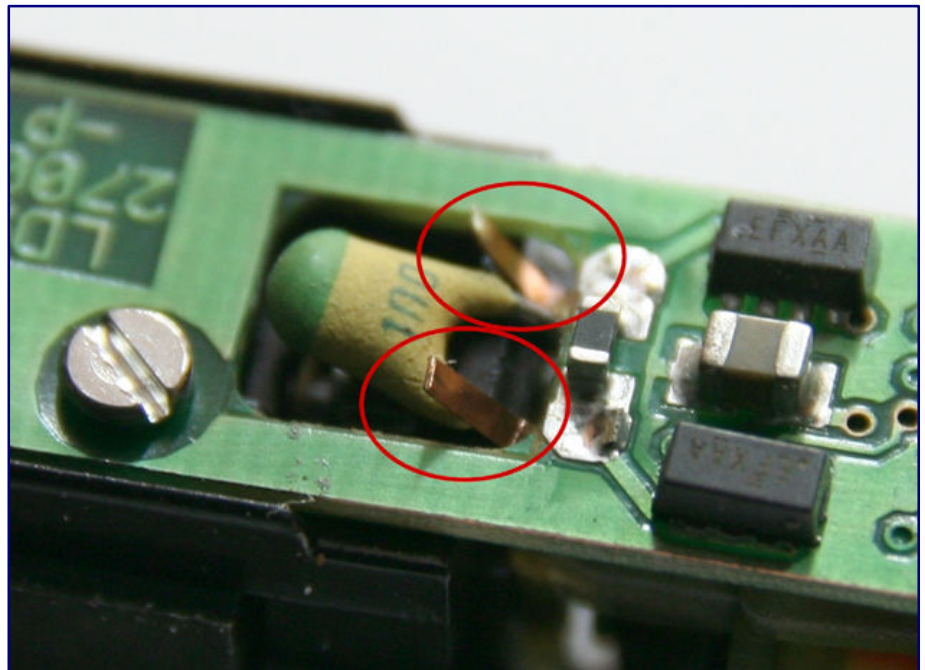

The motor contacts marked in the picture must be checked carefully during installation; otherwise, the model will not work later.

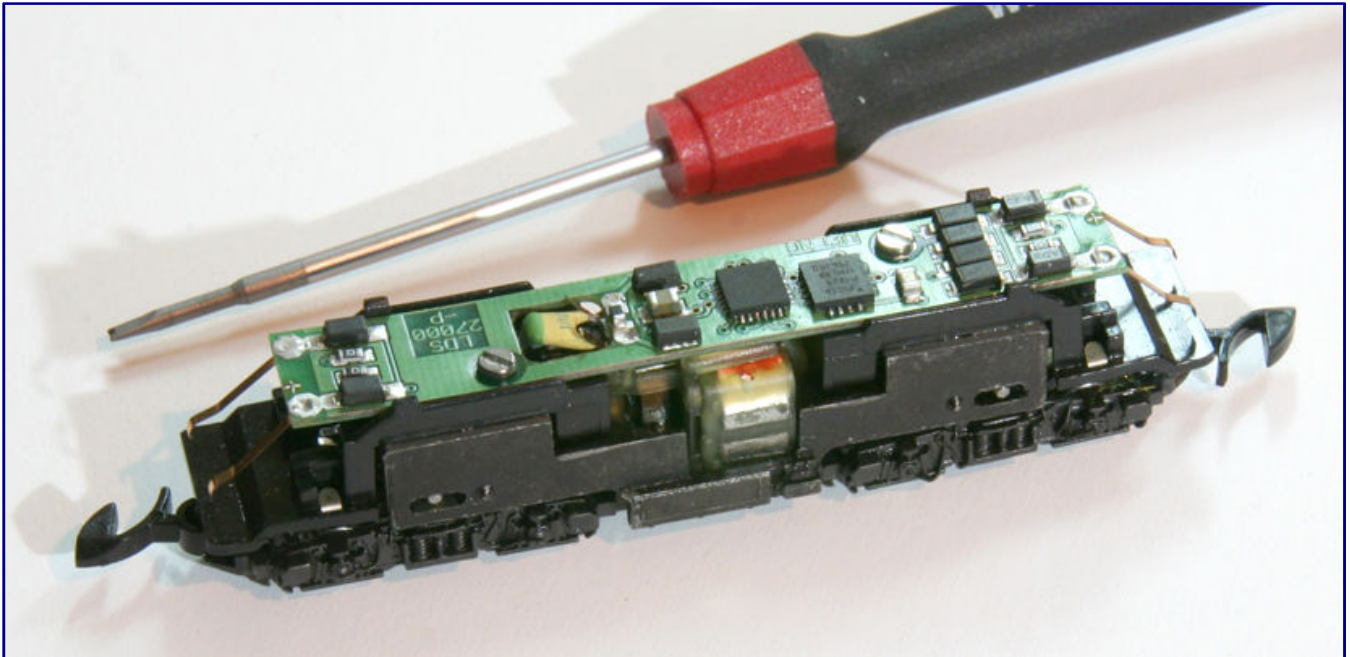

The locomotive decoder is inserted and fixed with the two screws supplied. Also the contact flags at the ends for controlling the light emitting diodes are already in position.

The four copper strips at the decoder ends make new contacts with the LEDs. In order for this to work properly after remounting the body, we carefully bend these contacts into the positions shown in the photo.

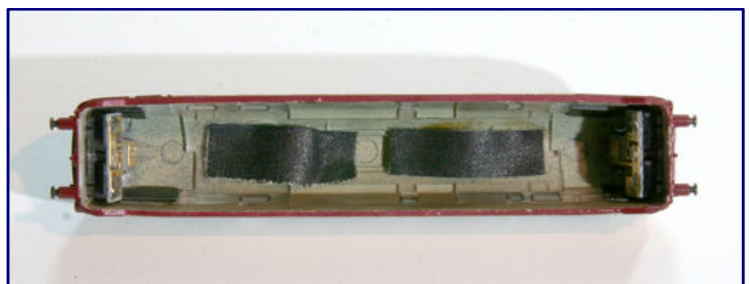
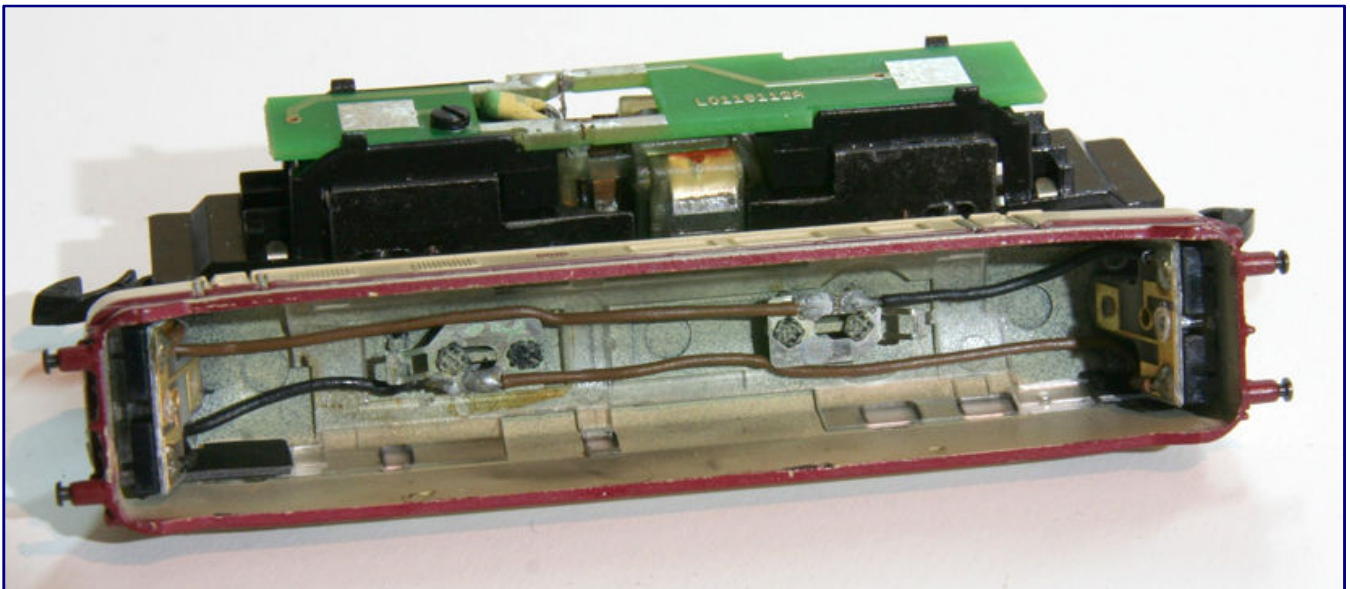

To use the Velmo-Profidecoder, remove the cable connections (middle photo) with the side cutter (bottom left photo) and cover the contact lugs with insulating tape (bottom right photo)

In the installation instructions it says that it might be necessary to shorten the plastic lugs protruding inwards on the housing cover. Our locomotive didn't require such a modification. With the replacement of the body on the locomotive chassis, the conversion is finished.

Programming or configuration?

To put it simply, the decoder software consists of two parts. First, there is the firmware, the basic operating system. Second, there is the part that can be changed by the operator, i.e. from the control panel, with the configuration variables (Configuration Variable, CV).

In this part of our small series, we will restrict ourselves to the DCC protocol, so the configuration variables of Selectrix (here called parameters, abbreviated "par") are not included. However, the functionality is mostly the same; in some cases, both systems even have the same numbers and number ranges.

Almost always one speaks of a "programming of the CV." Strictly speaking, this is wrong, because programming is the creation of software with the help of a programming language. The configuration variables, on the other hand, can influence the behaviour of the decoder firmware, so here we will consistently (and only correctly) speak only of configuration.

There are 1,024 CVs. But don't worry, most numbers are not used, because they are for decoders with operating sounds, concern the SUSI interface, which is also not available, or are manufacturer-specific for deeper functions of the decoder. We do not change the manufacturer's pre-settings.

The most important and therefore in all decoders uniform configuration variables are defined in RP.9.2.2 of the NMRA. Normally, only the following CVs are required:

CV#	CV-Name	Range	Default setting	Note
1	Locomotive address	1 ... 127	3	Should be changed in any case.
3	Start-up delay	0 ... 255	3	The higher the value, the slower the locomotive accelerates and the acceleration distance becomes longer. The value is the time in seconds from standstill to maximum speed.
4	Brake deceleration	0 ... 255	3	The higher the value, the slower the locomotive brakes and the braking distance becomes longer. The value is the time in seconds from maximum speed to standstill.
5	Highest speed	0 ... 127	92	So that a shunting locomotive does not run as fast as an ICE at the same speed level, the maximum speed can be specified here.

What the many other CVs mean, how to work with them and what can be done with them, can be found in the detailed Velmo configuration guide and will also be the subject of a focus article in an upcoming issues of **Trainini®**.

On to the test drive

The FCC of our test circle is now connected to a PC in the form of a netbook under Windows 7. The programmes freely offered by Doehler and Haass (D&H) for controlling the FCC and an updater for the FCC, the Trix-MS1 and all D&H decoders run on it.

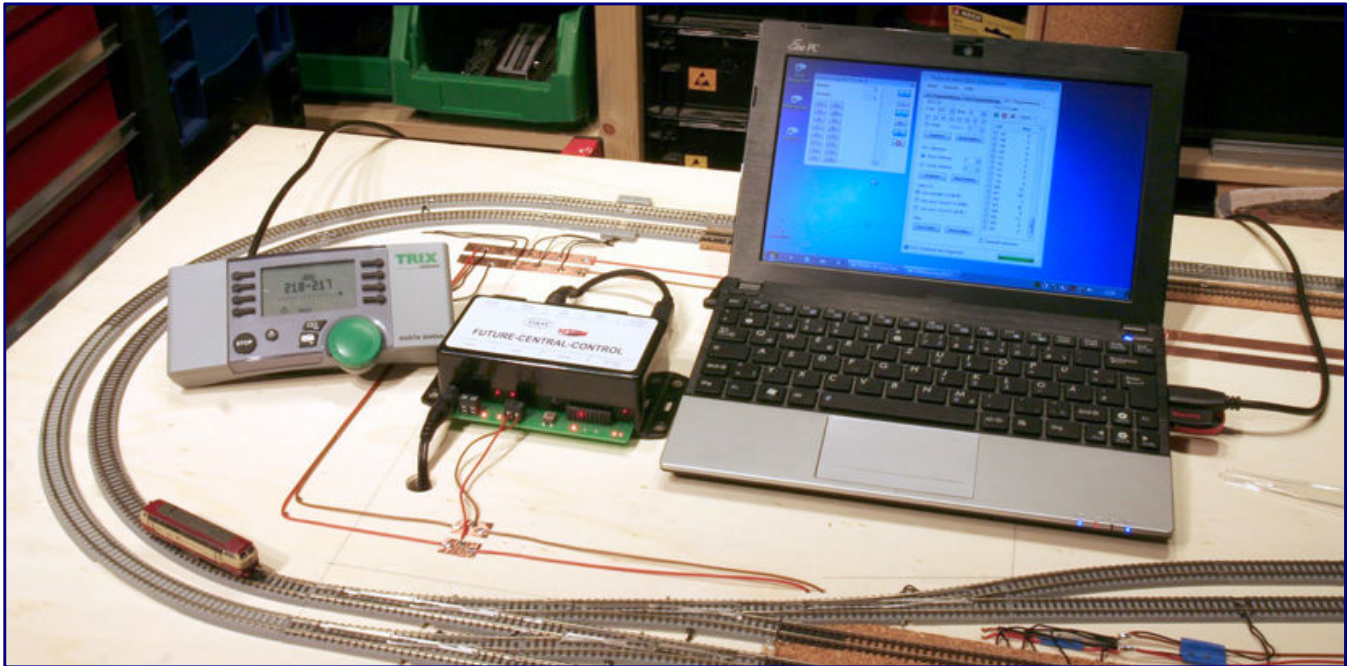

The current state of the test circuit can be seen here. However, the MS1 and the folding computer only stand for the photo on the disk, since the connection cables would interfere with operations.

If we connect the FCC to the PC after the installation of the programs, a driver for the USB connection will be installed first. When starting the FCC program, it asks for the (virtual) COM port, and for us it is COM3. In the status bar at the bottom left we can see the successful connection.

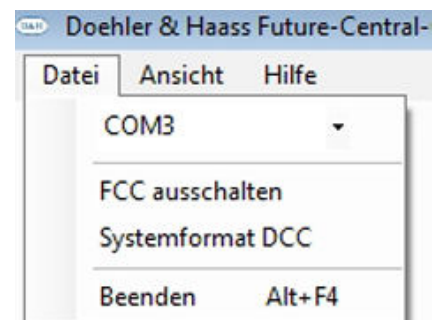
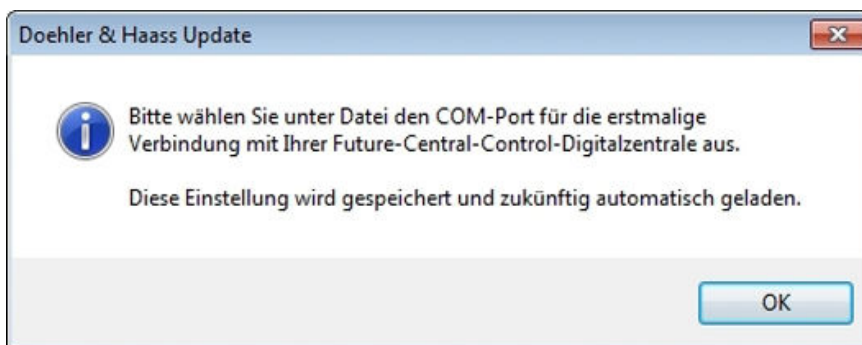

In order to control a locomotive, it must first be newly created in the control panel. The new locomotive is set to the DCC protocol with 28 speed steps and address 3. A click on the green dot with the tick saves everything and the locomotive control appears (see photo sequence on page 31 above).



The controls in this dialog are almost all self-explanatory. The slider changes the speed setting, the two arrow keys are for changing the direction and the star key switches turn the lights on and off.

This is also the first test to see if the installation of our decoders worked. The locomotive must switch on the lighting on command and change according to the direction of travel. If this is not possible or if the locomotive does not react to any command at all, then in almost all cases there is a faulty connection of the motor contacts.

The locomotive control opens as a new window and remains operable next to the FCC program (fig. on page 32 above). In this way, up to 32 locomotive controls can be kept open at the same time and extensive systems can also be operated (Fig. on page 32, centre), if we don't lose track of what's going on

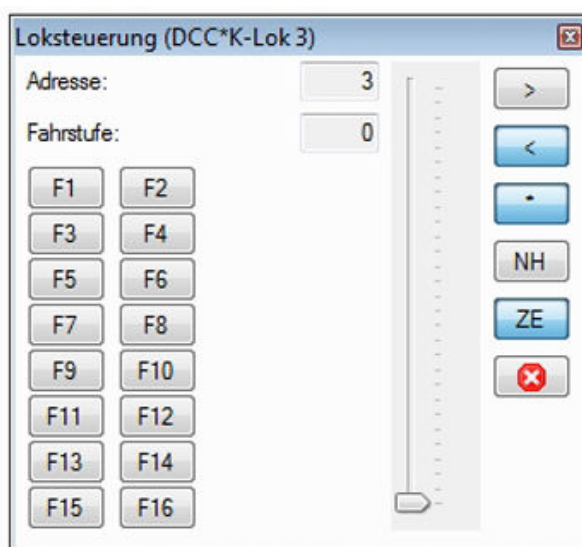

All changes made via the locomotive control are immediately visible on the MS1, and vice versa. Parallel operation of the FCC PC program and MS1 is possible without any problems.



Switching on the front lighting and changing red tail lights are part of the functional tests after the decoder has been installed. If we do not find any faults, we start operations.

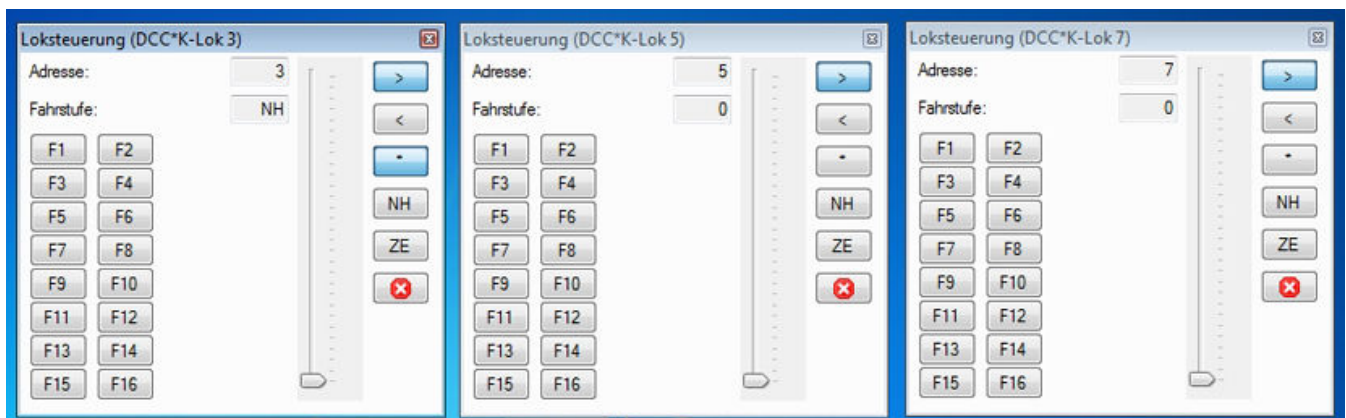
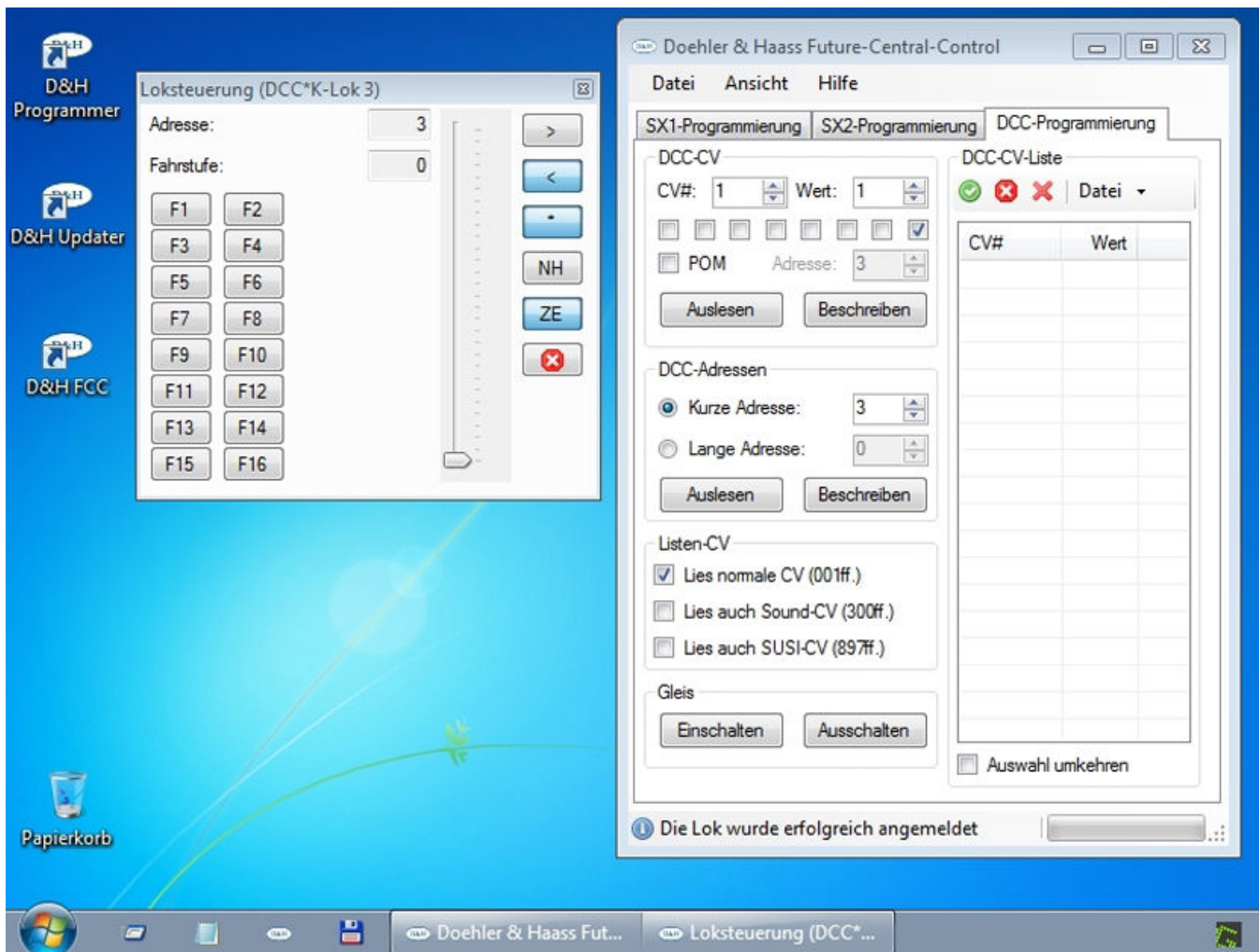

An important feature of the FCC program is the program item "View → Vehicle Decoder Programming → Register DCC Programming" (sic).

How this looks on the screen is shown on page 33 (left) right. Here you can configure the decoder for the selected locomotive. The operator can read all CVs, one after another, and save this list to a file.

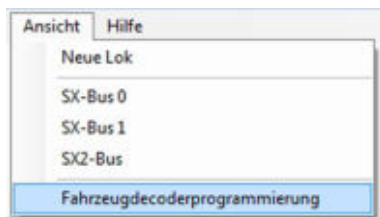

We do this right now with the newly digitized locomotive, and in this way have a backup copy of the factory settings, which we can use again even after a complete “misconfiguration”:

“Start Read all DCC-CV” (see screenshot), the locomotive responds with short engine noises as confirmation. Reading the CV takes quite a long time, but a status bar keeps us informed of the progress. In the list, the display moves from CV to CV and enters the current values there.

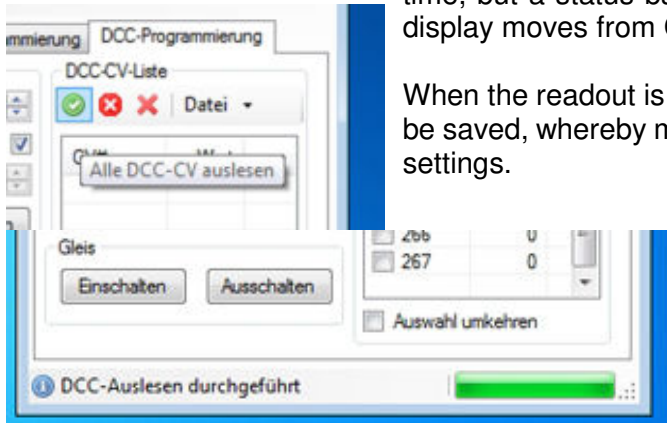

When the readout is finished, a status message appears. Now the list can be saved, whereby meaningful file names facilitate the later retrieval of the settings.

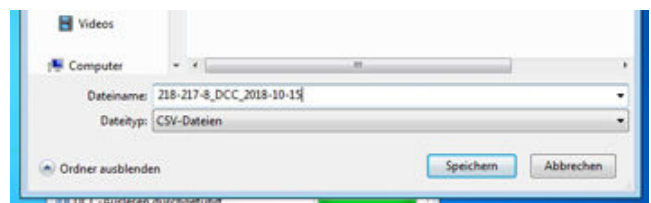

Need for adaptation of the test layout

After the first test runs, our test oval underwent minor changes. The originally installed Rokuhan curved tracks on the left side have been replaced by normal track sections. There are (still) no transition tracks, so that there were permanent problems at the immediately following turnout, which could only have been solved with significant effort.



The transition from the elevated to the level tracks causes problems, as shown here by the example of the Silverlings: They bump over the insulation, which can lead to derailments. As Rokuhan does not offer transition tracks, to date, we replaced their curved track.

In addition, the optical appearance of the elevation in radius R220 is not really that good. What is possible with short freight cars looks terrible with long passenger cars. With flex tracks in a larger radius, and with a slightly less pronounced elevation, a much more realistic effect can be achieved.

We had to improve the transitions from Rokuhan to Märklin track in the area of the fictitious station because of electrical contact problems, which was done with the help of short soldered wires. After intensive track cleaning our test locomotive 218 217-8 is now making its rounds without any problems.

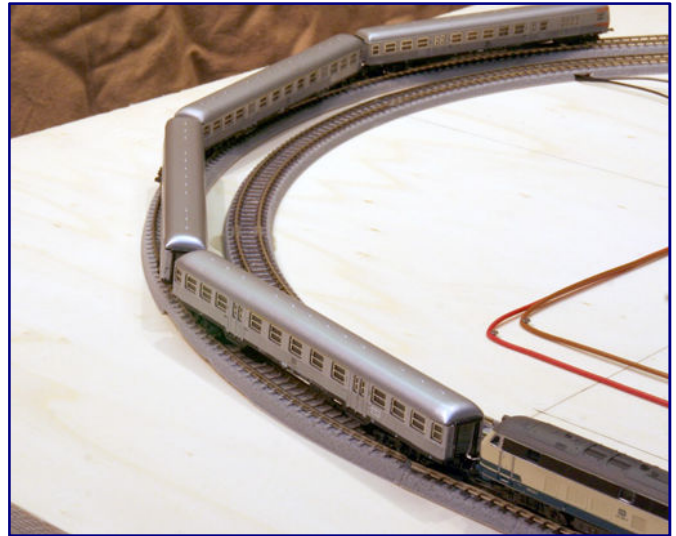
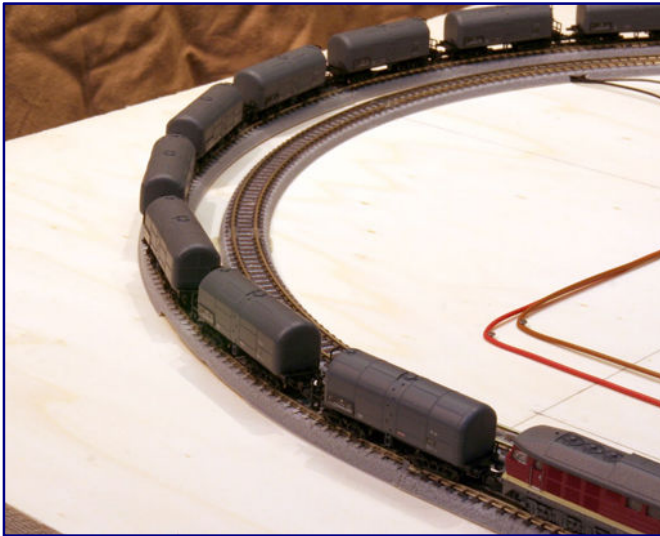

Depending on the passage with rather short freight cars (picture left) or long passenger cars (picture right), the elevation has a different impact on the viewer. Against the background of a loss of operational reliability, we were not convinced, which is why the decision explained in the text was made.

All photos (except page 22) and illustrations: Andreas Hagendorf

Further pages to the article and materials used:

[http:// www.Velmo.de](http://www.Velmo.de)

<https://www.1zu220-shop.de/VELMO-Decoder:::1000038.html?MODsid=19b5a89aac1f90c79099051a0f248eb4>

<https://doehler-haass.de/cms/pages/downloads/digitalsystem.php>

Z. Scale. Hobo

 by ARCHISTORIES®

USA-Type Train Station 'Goldtree' · Z Scale

A world-wide *exclusive* offering from Z.Scale.Hobo, USA

Track Side

City Side

www.zscalehobo.com · +1(949)981-7643

Maintenance and care of small trains (part 7)

A puzzle game with many pieces

Our “Maintenance & Care” series has been running for five years now. At irregular intervals, we announce tricks and tricks to help with cleaning, maintenance and assembly. We are also gradually increasing the level of difficulty of the challenges. Today, the three-axle bogies of modern locomotives are our subject.

Anyone with little experience in handling three-axle bogies will be grateful for a constructive change that Märklin has made to the East German V 300 in particular. In the locomotive better known today as “Ludmilla”, the middle axle is no longer driven, but runs loose within the bogie.

Other popular older models, including the former Paradelok Series 103, operate with three driven axles in the bogie. The 151 series is also such a candidate, as is the older 150 of the model. However, the middle wheels do not provide traction, because when correctly mounted the middle wheels are slightly higher than their outer neighbours, and therefore have little rail contact.



Regardless of whether we look at a class 103 from 1974/75 (right) or the 151 from the first decade of the new millennium (right): The drive principle of these six-axle locomotives, and their derivatives on the same chassis, has remained unchanged for decades

This special feature, which is usually unknown to beginners, and therefore unrecognised by them, can only be seen on closer inspection and poses particular challenges to the reassembly of the bogie. An incorrect assembly sequence causes increased friction on the gearbox. To the owner's surprise, the freshly serviced model then runs worse than before the service.

Before such a phenomenon gives rise to a puzzle, we would like to give some instructions and practical tips today. These are intended to enable our readers to safely master and understand six-axle bogie locomotives as well. There is only one way to easily assemble the inner workings of the bogie frame.

To illustrate the construction of a three-axle bogie of the series 103, 151 and some other models, we have numbered the axles and gears starting at the track (below). Here we count from the front to the back and continue the counting sequence for the higher gear wheels.

The axles with the gears pressed on therefore have the numbers 1 to 3. To ensure that they all have the same direction of rotation, they must not mesh with each other. This is done by the intermediate gears 4 and 6 in the higher plane. They in turn make the connection to the spur gear 5, which forms the top end of the bogie drive, and into which a worm engages.

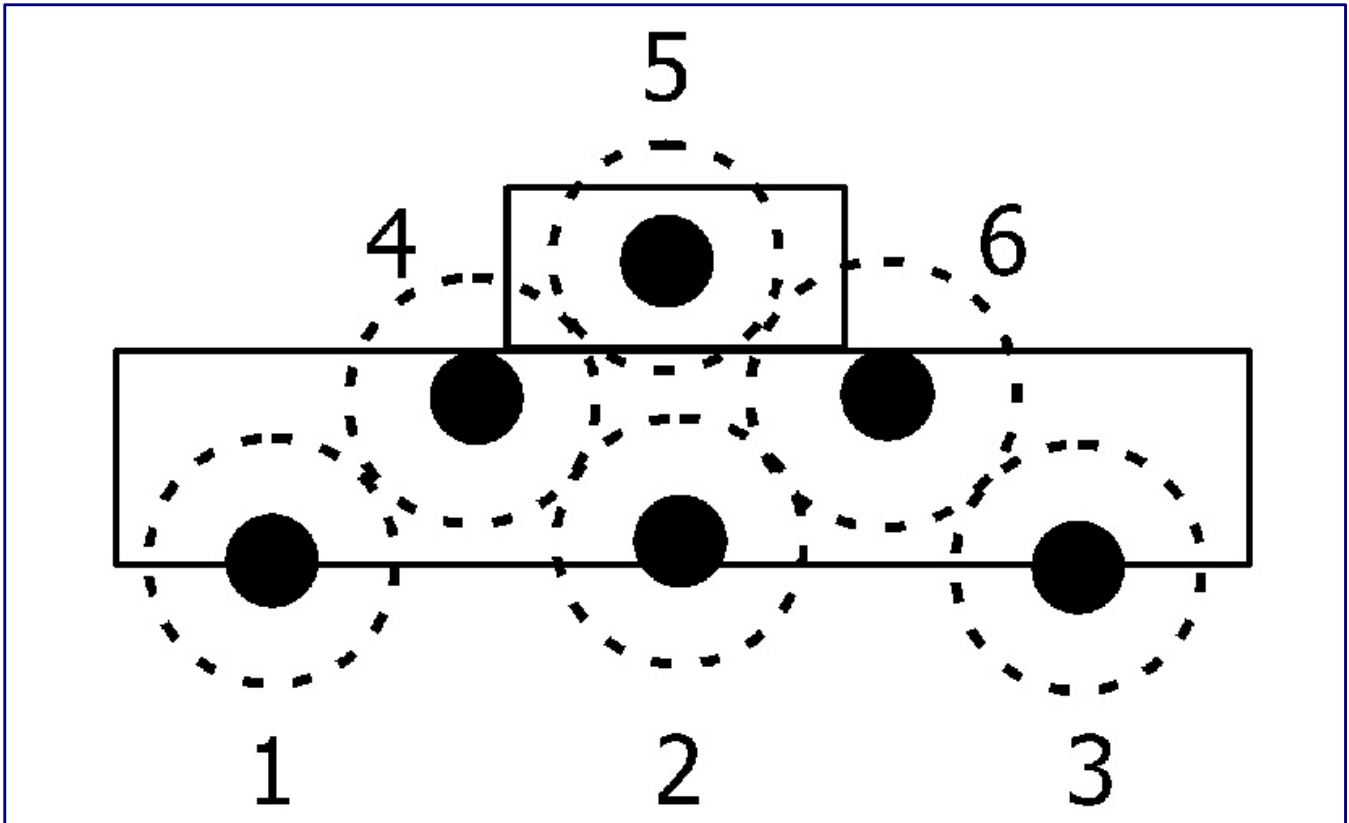

Our instructions for re-assembling the bogie refer to the numbering of axles and gears shown here. Drawing: Peter Grundmann

If the bogie is dismantled to clean its components and lubricate them again later (see also previous parts of this series), the owner is inclined to reinstall the three axles 1 to 3 first and then to work his way up, i.e., to let the intermediate gears 4 and 6 follow in order to place the gear 5 on them.

Because of the teething, however, it will not be possible to return the spur gear to its original position. The bogie then works with increased friction and it is not uncommon for the suddenly poorly running locomotive to land on the used goods market. Those who recognize the cause of this phenomenon will be offered a real bargain instead of a seemingly worthless spare parts store for cannibalization.

The only correct order of installation is as follows: The first step is one of the two intermediate gears (4 or 6), which is placed in its intended bearing from above. Already now follows the spur gear 5, which is also fixed with an inserted axle.

Our reader Peter Grundmann has built himself an extremely helpful maintenance tool, consisting of a base plate with receptacle and a mandrel with handle. During the work it offers lateral support against tilting and is also a positioning guide.

Continues on page 38

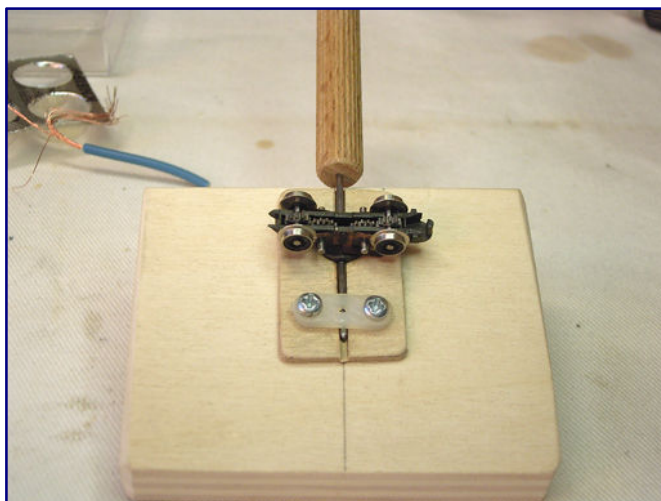
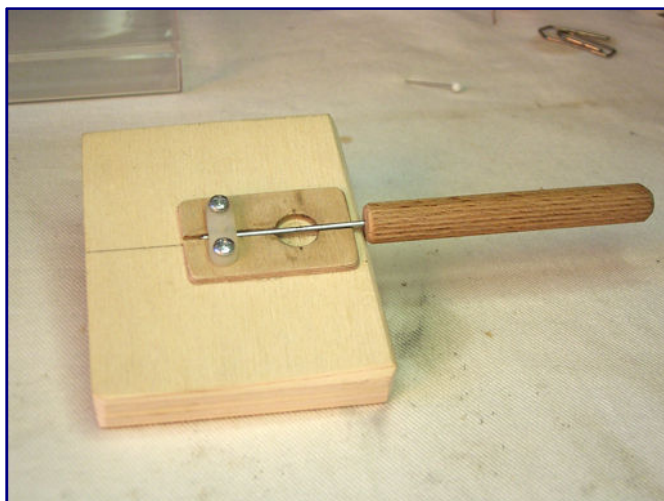

With this self-built auxiliary tool it is possible to fix an inverted bogie, so that it is easier to clean and maintain. Photos: Peter Grundmann

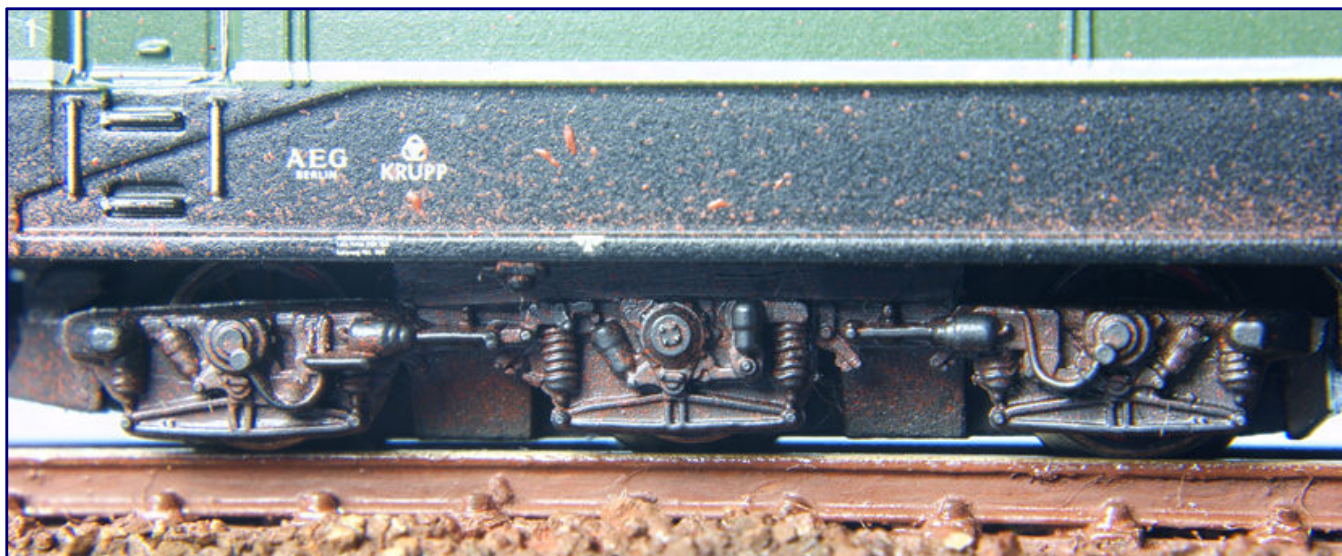

If a six-axle bogie with driven centre axle is not correctly assembled, all three wheels can usually be seen at the same height (middle picture). If the assembly is correct, however, the middle wheel is slightly higher (picture below), so that its tread has no track contact, as can be seen here in the macro picture.



It is easy to check whether the middle axle is driven by placing the locomotive on its side or turning it upside down: It then shows a completely covered central axis or, as here, a sprocket at this point.

If the model railroader works without such an assembly aid, much more care and experience are required, because one of the gears slips quickly out of its bearing or the wheel grinders jump to the outside. Coupling and pressure spring also disappear from the still open coupling shaft. We must not be discouraged by such problems.

But Peter Grundmann's auxiliary tool not only replaces a third hand when re-assembling a bogie. Smooth-running turning can thus be checked in freewheeling mode, and it also facilitates cleaning and, above all, lubrication activities.



This photo shows the construction of the bogie. It is important that the two models are not interchanged, as they differ in the bronze spring contacts to the chassis. When assembling, make sure that the wheel grinders are returned to their original position before the bogie is completely re-assembled.

But back to the assembly of the bogie: In the bogie that is still equipped with only two gear wheels (4 or 6 and 5) we now insert the middle axle 2, which can only slide so deep into the bearing in this step that it has no subsequent track contact. The second intermediate gear may follow next. After that, only the outer axles 1 and 3 are missing, the assembly of which does not require a fixed sequence.

Careful, crocodiles!

If our instructions apply to all six-axle bogie locomotives of older construction dates, there are also some models that were also equipped with three-axle and four-axle bogies, but which are technically different.

In this part of the series we don't want to go into all their special features and only give two basic hints. Thus we find two four-axle bogies on the steam locomotive of the class 96 (ex Bavarian Gt 2x4/4) contrary to the model; the Swiss crocodile Ce 6/8III comes closer to the model from this consideration. The latter locomotive is widely used in its green version (Art.-No. 8856), as it represents Märklin's "heraldic animal" in the scale 1:220.

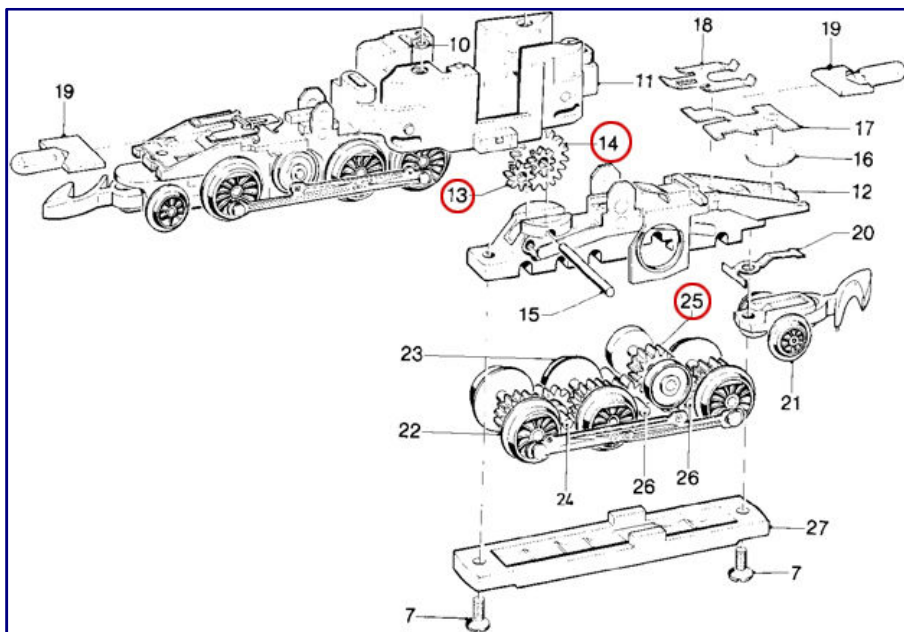

The gearbox in the bogie of the Swiss Crocodile is more complicated than that of other bogie models, because of the parts 13, 14 and 25 marked in red. When disassembling and re-assembling, this exploded view enclosed with the model is therefore a welcome aid. Exploded view: Märklin

Both locomotive designs have in common the rod connections between the axles, which in the case of crocodiles also includes a high mounted blind shaft.

The Swiss articulated locomotive has additional intermediate gears, one of which also has two sprockets (part 14 in the explosion drawing).

Here the disassembly should take place step by step and each one should be well observed as well as marked.

The production of photographs of the individual phases and an accompanying look at the exploded view drawing enclosed with the models or to be found on Märklin's web pages is particularly helpful.

The correct seating of the gears is also responsible for smooth running, as all gear teeth must point in exactly the same direction. Misaligned gears lead to problems in the drive, and cause the model to stall later. Therefore, smooth running should be checked before the top gear meshes with the worm.

Sometimes, several corrections are necessary before everything is properly positioned. Here, it is important not to be discouraged. Although a lot of time goes into the first "walking attempts," personal experiences also grow with them.

The fact that we too are not spared from mishaps should be proven by another construction. While preparing this article we have maintained a German crocodile of the class 194, which was listed in the program under the article number 8822. The model of this articulated electric locomotive also works with bogies.



As a demonstration example for the cleaning and maintenance of a more complicated bogie locomotive, we selected the German Crocodile with the article number 8822. Finally, it showed its very special pitfalls.

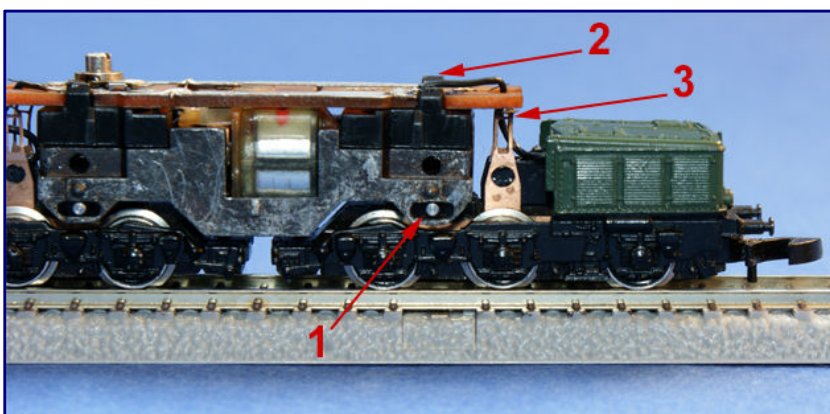

As soon as the guide axis (1) has been removed, the bogie can be removed downwards. Special attention should be paid to the stranded wire (2) soldered onto the printed circuit board. In our case it proved to not be very strong. Also the contact spring to the chassis (3) should not be bent or damaged during maintenance work.

The presentation copy for this contribution was an older copy from the long construction period between 1983 and 2000.

Typical defects of older electric locomotive models are shrunken and nonflexible roof conductors, which usually stand out due to a pink colour cast, and insulators sitting at an angle.

Fortunately, this was not the case with the test candidate, but it exhibited something comparable in its interior.

There some wire connections turned out to be weak. They make the electrical connection from the circuit board to the light bulbs in the ends. Because

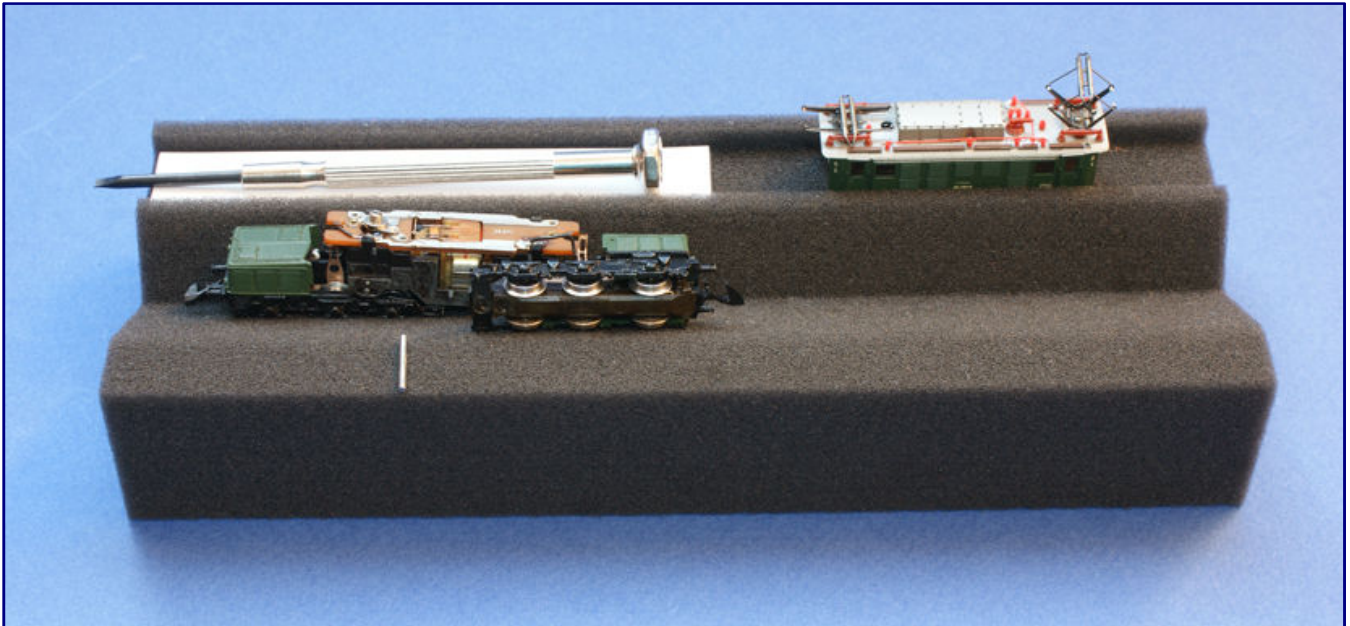

If everything goes well, the bogie is placed close to the trolley block after loosening and is accessible there for maintenance work. If the access options are not sufficient, the stranded wire should be better de-soldered from the printed circuit board..

the bogies do not sit under the locomotive body, but are pushed forward, the front lighting is not part of the locomotive body, as is the case with the 103, 150 or 151 series.

If we remove a bogie from this locomotive by pulling the axle for the large gearwheel from the casting block, the strand still provides a firm connection between the two parts, even if it cannot be subjected to load. It can either be loosened by de-soldering from the circuit board or well secured during maintenance work so that it cannot tear off.

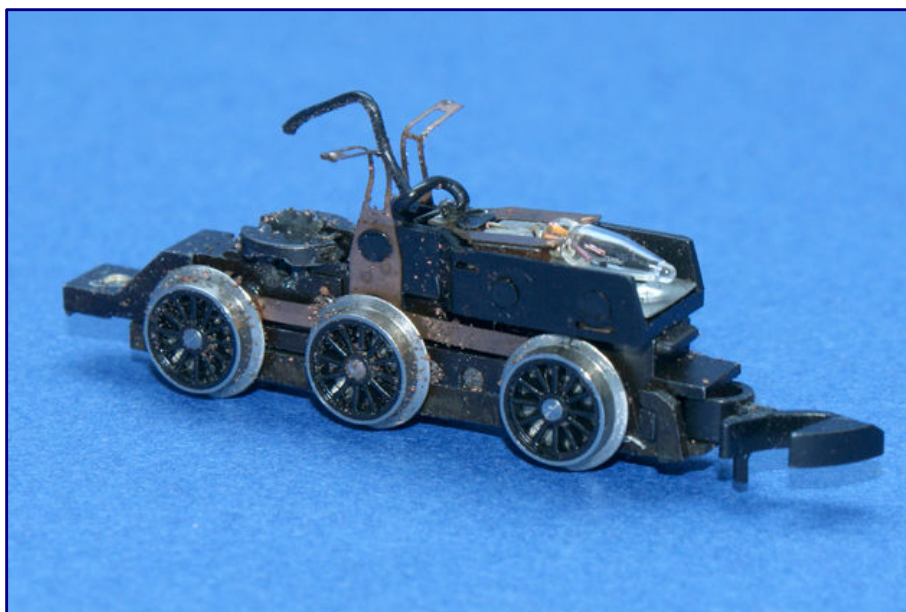

Misfortunes happened and so one of our bogies landed in the gutter because the strand on the printed circuit board broke. Instead of being freshly cleaned, it now turned out to be heavily soiled. The thorough inspection also revealed cracks in one of the contact springs, replacement was required.

For the necessary cleaning we have decided to save time by securing the cable connection. In the locomotive service bed, this does not cause any problems.

For the necessary cleaning, we have to go through the already indicated mishap when we spray clean the gearbox of the model to remove adhering dirt and used lubricant.

The work is carried out by an open window so that vapours can be easily extracted. During spraying we have to work around several times to reach all corners of the gearbox.

But a single mistake is enough, and the bogie hangs "by a silk

thread," i.e. the connecting wire. Since the inner copper wire was obviously already quite weak, it

immediately tore off at the soldering point to the circuit board. The bogie lands on the roof and slides down into the gutter.

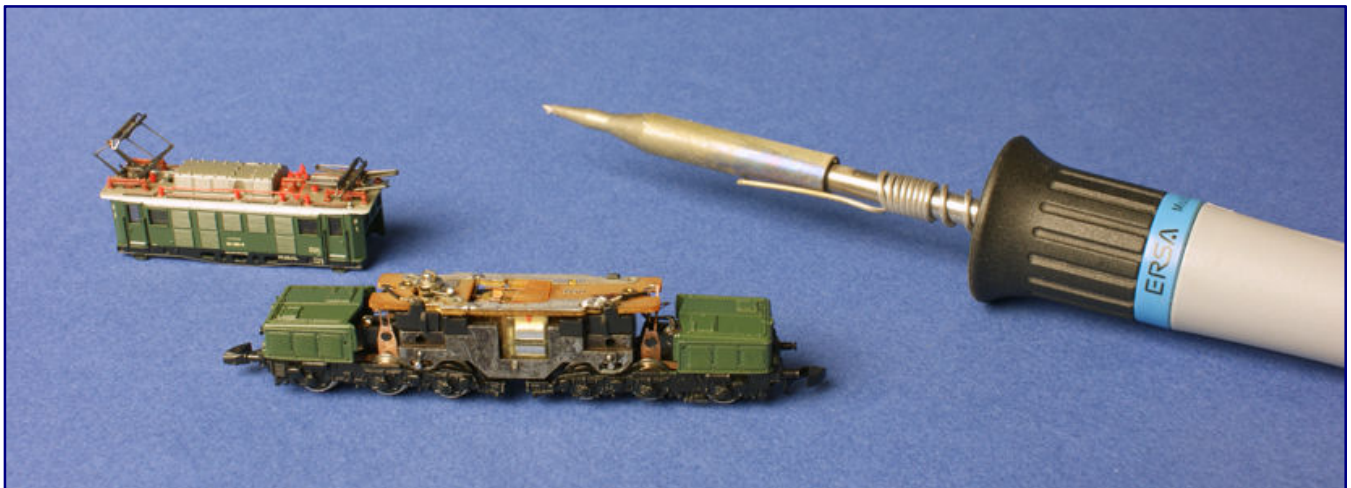

Photo above:

If all parts, as shown here, are laid out and photographed according to their location and correct positioning, the photograph can be a valuable aid in re-assembling the locomotive. If parts are not clearly identifiable and assignable, they should be marked in an appropriate manner. We have protected the coupling and pressure spring from loss in a small box. Our bogie is already waiting for assembly and new lubrication.

Photo below:

If the bogies have also been de-soldered, restoring these connections is the last maintenance step. In order to avoid accidental swapping of the two bogies, we recommend never loosening both bogies at the same time.

Although it can be recovered quickly thanks to a sufficiently long ladder that hastily arrived, the spring bronze brackets, which form a sliding contact with the underside of the circuit board, are now bent.

When attempting to straighten them, one of them also tears them down immediately. The bogie is therefore no longer usable. The manufacturer Märklin, Ersatzteile-1 zu 220 by Axel Reimann or also Spur Z Ladegut Josephine Küpper can be used as a source for quick replacement. We, too, can be helped so quickly.

Please note that the two bogies of the German crocodile, but also of many other models, are not completely identical: Not without reason do they have different numbers in Märklin's exploded views and parts lists!

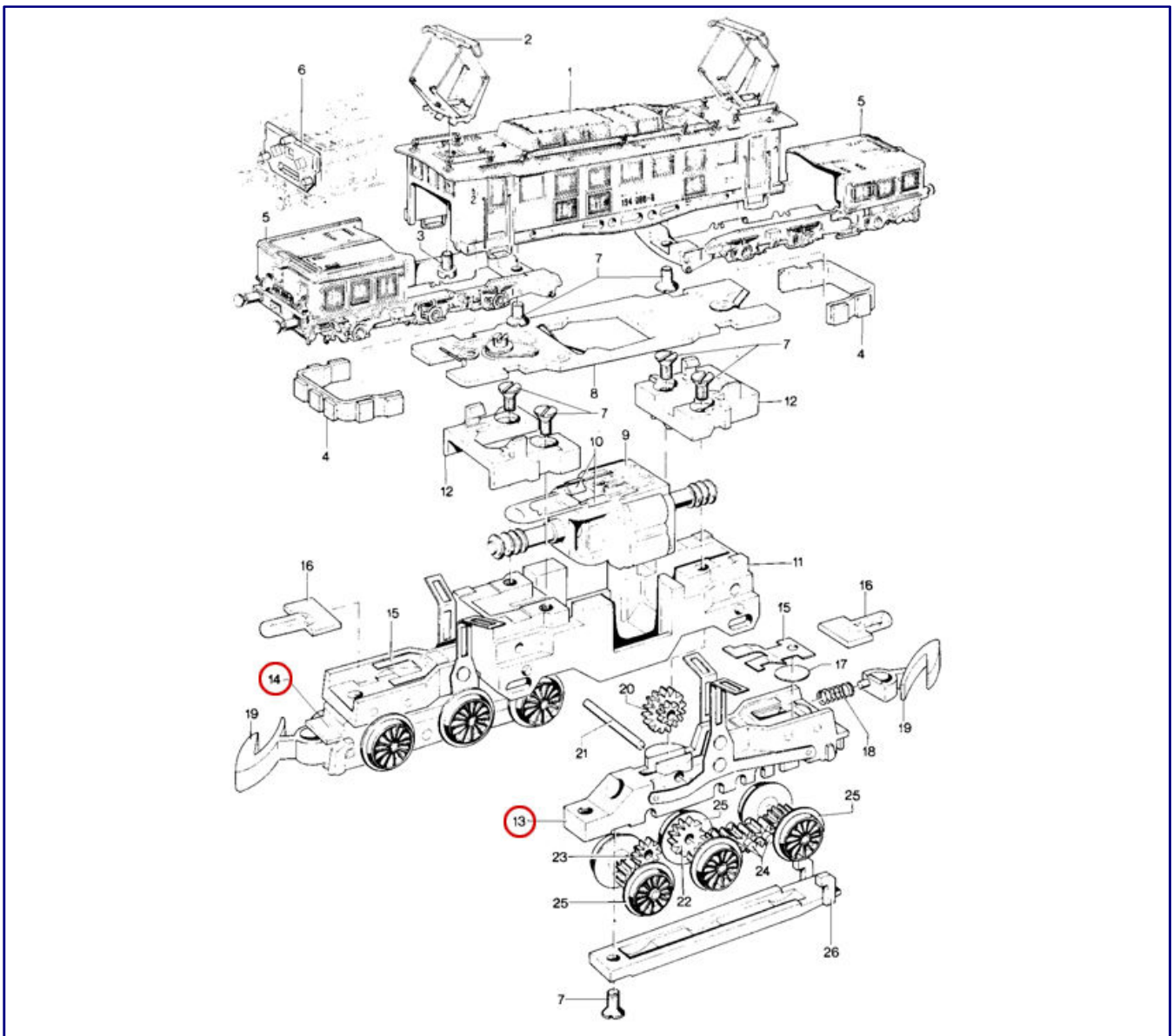

Attention, source of error: The two bogies of the 194 series have different part numbers in the exploded view as well as in the parts list for a reason (see red markings). Exploded view: Märklin

If they are only swapped, there is no short-circuit, but the pre-defined driving direction changes and they no longer fit with other models. The locomotive with the exchanged parts always runs in the opposite direction to all other vehicles with the same polarity of the driving voltage.

In the Märklin model with article number 8822 and all identical variants, however, accidental interchange is usually not possible due to the stranded connection. In our special case, however, it must at least be ensured that the wrong bogie is not ordered by mistake and that two identical bogies are mounted at the end.

With this in mind, we build up a new bogie on the basis of the newly purchased frame with still usable parts, re-assemble the gearbox and lubricate its components.



In the meantime, our 194 series has also been returned to layout operation after cleaning, maintenance and repair, and is now in use in front of one of the first container trains.

After the reassembly of the assembled component, only the wire remains to be soldered to the circuit board and our German crocodile is almost like new again. With a little practice and patience this should not cause any problems for our readers in the future.

Helpful exploded-view drawings and parts list:

<http://www.maerklin.de>

Sources of supply for (used) spare parts:

<http://www.ersatzteile-1zu220.de>

<http://www.spurzladegut.de>

Tools, cleaning agents and lubricants:

<http://www.lokliege.de>

<https://modellbahnambulanz.de>

<http://www.viessmann-modell.de>

<http://www.z-hightech.de>

Note for English readers: The literature section that follows is not translated into English because the original text of the books involved are in the German language. The original German is left here for information purposes only.

Die VT 08⁵ und VT 12⁵ der DB **Eierkopfgeschichte(n)**

Wer hoch aufsteigt, der kann auch tief fallen. Diese Weisheit trifft auch auf den VT 08⁵ der Deutschen Bundesbahn zu. Als Paradezug der jungen DB bestimmt und zum Abholen der Weltmeister aus Bern erkoren, verschwand er schnell aus dem hochwertigen Reizzugverkehr. Der EK-Verlag hat dem Eierkopf zusammen mit seinem Bruder VT 12⁵ für den schnellen Bezirksverkehr ein literarisches Denkmal gesetzt.

Heinz R. Kurz
Die Baureihen VT 08 und VT 12⁵
Die „Eierköpfe“ der Deutschen Bundesbahn

EK-Verlag GmbH
Freiburg 2018

Gebundenes Buch
Format 21,0 x 29,7 cm
248 Seiten mit 372 S/W- und 40 Farabbildungen

ISBN 978-3-8446-6033-3
Best.-Nr. 6033
Preis 49,90 EUR (Deutschland)

Erhältlich direkt ab Verlag
oder im Fach- und Buchhandel

Vor Ausbruch des Zweiten Weltkriegs war der deutsche Fernschnellverkehr wegweisend. Das sternförmig auf die Hauptstadt Berlin ausgerichtete Netz war hinsichtlich seiner Reisegeschwindigkeiten weltweit einmalig. Grund dafür waren kurze und beschleunigungsstarke Einheiten in Form der zwei- bis vierteiligen Dieselschnelltriebwagen.

Sie nutzten die elektrische Leistungsübertragung, was schließlich auch an aus der Oberleitung gespeiste Einheiten denken ließ. Immerhin gab es in Schlesien und Bayern schon zusammenhängende elektrische Netze. Der aus dieser Entwicklung hervorgegangene, spätere ET 11 markiert hier den Höhe- und vorläufigen Schlusspunkt, denn der Krieg sorgte für ein jähes Ende und eine Zäsur.

Das neue EK-Baureihenportrait zu den Eierköpfen der Bundesbahn setzt genau in diesem historischen Kontext an, strukturiert die Entwicklungen wie auch Ausgangspunkte und zeigt das Ziel der modernen Zugförderung ab 1949 auf.

In eben dieser Linie stehen die beiden Dieseltriebwagen VT 08⁵ und VT 12⁵, mit denen die DB einen Neuanfang wagen wollte. Ihr Konzept wurde mit Hilfe von Versuchsfahrzeugen entwickelt, darunter der bekannte „Kartoffelkäfer“ VT 92 501, und die neue Leistungsübertragung in modernisierten oder fertiggestellten DR-Schnelltriebwagen betrieblich erprobt.



Schon damit wird klar, dass es eines Signals des Aufbruchs bedurfte: Der VT 08⁵ sollte die Nachfolge der SVT antreten, um Geschwindigkeit und Komfort zurück auf deutsche Schienen zu bringen. Auserkoren als neues Paradedfahrzeug der Bundesbahn, stand sein Bruder VT 12⁵ für den schnellen Bezirksverkehr stets im Schatten.

Doch auch die Blütezeit des VT 08⁵ währte nur wenig mehr als zehn Jahre. 1952 mit großen Erwartungen in Dienst gestellt, war es der dreiteiligen Einheit aus VT 08 502, VM 08 509 und VS 08 502 vergönnt, die Fußballweltmeister von 1954 zurück nach München zu bringen. Doch schon drei Jahre später stand dieser Zug selbst im Schatten des TEE-Triebzugs VT 11⁵, nachdem er zeitweise noch als Ersatz oder Verstärkung für ihn einspringen musste.

Unaufhaltsam begann nun sein Abstieg und die Einheiten wurden sukzessive bis Anfang der Siebziger zu Nahverkehrstriebzügen umgebaut, denn der schnelle Fernverkehr war längst Sache elektrisch bespannter Wagenzüge geworden. Fahrten ins westliche Ausland nach Paris, Amsterdam, Oostende oder Zürich waren nun endgültig Vergangenheit.

Gemeinsam mit dem VT 12⁵ wanderten die einstigen Hoffnungsträger und Wirtschaftswundersymbole in die „Provinz“ nach Niedersachsen und Schleswig-Holstein ab. Das vorliegende Buch spannt dabei einen Bogen über rund vierzig Jahre Eisenbahngeschichte.

Sie berücksichtigt die technische Entwicklung der Triebwagen ab 1948 ebenso wie Beheimatung, Umlaufpläne oder das sich wandelnde Einsatzbild. Auch die aus ihnen abgeleiteten sechs für die US-Armee gebauten Salon- und Lazarett-Triebzüge VT 08⁸ finden hier ihren Platz.

Da die Dieseltriebwagen mit dem viel zu engen Führerstand längst einen Kultstatus bei den Eisenbahnfreunden erreicht haben, wovon auch die Modelle im Maßstab 1:220 zeugen, wurden zuletzt auch die beiden Museumszüge des VT 08⁵ und VT 12⁵ nicht vergessen.

Damit wird das Buch zu einer runden Sache in gewohnt hoher Bearbeitungsqualität. Das gilt auch für die Bildauswahl und deren Wiedergabe. Alle in den Texten behandelten Entwicklungs- und Einsatzphasen werden mit geeigneten Aufnahmen und Dokumenten untermauert.

Die Struktur des Buches folgt einer chronologischen Abhandlung, in der Autor Heinz R. Kurz die einzigen, vermeidbaren Schwächen des Titels hinterließ: Einige Male verlässt er diese Spur und schweift in Jahre ab, die erst Gegenstand eines folgenden Kapitels sein sollten und dort meist auch wieder auftauchen. Das führt bisweilen dazu, dass der Leser irritiert wird und dem Geschriebenen stellenweise nicht folgen kann.

Glücklicherweise beschränken sich diese „Ausrutscher“ auf die Betriebsgeschichte und erweisen sich für das Gesamtverständnis daher auch nicht als nachhaltig störend. In Summe ist bei alledem ein lehrreiches, vielseitiges und durchweg lesenswertes Portrait eines beliebten Zuges herausgekommen, das ohne jeden Zweifel wieder seine Liebhaber finden wird.

••••• Publishing pages with reference possibility: •••••
••••• <https://www.eisenbahn-kurier.de> •••••
••••• <https://www.ekshop.de> •••••

Rheinische Eisenbahn über Coesfeld Die Kursbuchstrecke 224c/284

Die Rheinische Eisenbahn-Gesellschaft stellte einst eine Verbindung zwischen Duisburg und Quakenbrück her. Ein aktueller Band aus der Reihe Sutton-Zeitreise zeichnet die Geschichte dieser Strecke zwischen Oberhausen und Rheine nach. Sie führte einst abseits der großen Hauptstrecken über Dorsten und Coesfeld, ist heute aber nur noch in Teilen vorhanden.

Manfred Diekenbrock / Daniel Michalsky
Die Eisenbahn zwischen Ruhrgebiet und Münsterland
Oberhausen – Dorsten – Coesfeld - Rheine

Sutton Verlag GmbH
Erfurt 2018

Gebundenes Buch
Format 17,0 x 24,0 cm
120 Seiten mit ca. 160 teils farbigen Abbildungen

ISBN 978-3-95400-938-1
Preis 19,99 EUR (Deutschland)

Erhältlich direkt ab Verlag
oder im Fach- und Buchhandel

Die beiden Autoren Daniel Michalsky und Manfred Diekenbrock sind Mitglieder der Eisenbahnfreunde OnWheels e.V. Zusammen veröffentlichten sie bereits einen von uns ebenfalls vorgestellten Bildband über die Marschbahn, die DVD „Lebendige Eisenbahngeschichte“ sowie zahlreiche Artikel und Zugbegleithefte zu Sonderzugfahrten.



Im vorliegenden Band präsentieren sie nun rund 160 faszinierende, historische wie auch aktuelle Aufnahmen, mit denen sie den Bahnverkehr zwischen Oberhausen, Dorsten, Coesfeld und Rheine dokumentieren möchten. Dieser Abschnitt der ehemals Rheinischen Eisenbahn-Gesellschaft zwischen Duisburg und Quakenbrück ist heute nur noch in Teilen vorhanden und lohnt daher einen geschichtlichen Rückblick.

Beeindruckende und gut wiedergegebene Aufnahmen zeigen die eingesetzten Fahrzeuge und den mit ihnen einhergehenden Wandel im Zugbetrieb. Auch die Betriebswerke entlang der Strecke, die Bahnhöfe und Anschlussbahnen finden (überwiegend) ihren Platz.

Wenn wir an dieser Stelle unsere Ausführungen einschränken, dann liegt das an einem ganz speziellen Knackpunkt der Lektüre: Der Schwerpunkt ist nämlich auf Dorsten als Kreuzungsbahnhof gelegt worden, der heute einen ganz besonderen Wandel erlebt. Von dort richten die beiden Autoren ihr Augenmerk besonders auf den südlichen Streckenabschnitt, der heute noch befahren wird.

Der nicht mehr vorhandene nördliche Abschnitt kommt dadurch leider zu kurz, was sich vor allem darin zeigt, dass die beiden einst wichtigen Bahnhöfe Coesfeld und Rheine kaum berücksichtigt werden. Das ist insofern sehr schade, weil gerade Rheine einst ein sehr wichtiger Knotenpunkt für den Güter- wie auch Personenverkehr war.

Die in diesem Buch behandelte Bahnstrecke führte direkt am ehemaligen Betriebswerk Rheine R vorbei und hatte dort auch einen betrieblichen Haltepunkt für die dort Beschäftigten. Fragmente des Bahnsteigs

lassen sich noch heute im Gestrüpp der Vegetation finden und der einstige Streckenverlauf in diesem Bereich daher gut abschätzen.

Gut hätte dem Buch hier auch eine größere Streckenkarte getan. Ebenso wäre der Leser, neben dem viel zu klein abgebildeten für Dorsten, für weitere Bahnhofsgleispläne dankbar gewesen, stellen sie doch einen Anreiz und auch Hilfen für modellbahnerische Umsetzungen dar.

Ausdrücklich gelungen ist, dass auch die Gegenwart ausführlich behandelt wird, denn der aktuelle Betrieb ist doch eher selten ein Thema von Streckenportraits. Hier zeigt sich auch eine Stärke des Autorenduos: Trotz ihres Interesses für die Streckengeschichte liegt ihre Kernkompetenz doch eher auf dem aktuellen Geschehen

Zur Betriebseinstellung zwischen Coesfeld und Rheine schreiben sie richtig, dass der letzte Personenzug aus Rheine den Bahnhof Coesfeld am 28. September 1984 erreicht hat. Das ist auch auf dem Schild des geschmückten Dieseltriebzugs Baureihe 624 abzulesen, der hierzu im Buch gezeigt wird.

Der aufmerksame Leser wird aber auch ohne exakte Kenntnis bemerken, dass in der Chronik am Ende des Titels das Betriebsende zwischen Rheine und Lutum schon für den 31. Mai desselben Jahres angegeben wird. Dies ist aber nicht schlüssig, weil Lutum in dieser Fahrtrichtung vor Coesfeld liegt.

Eine große Stärke des Buches und damit ein entscheidendes Kaufargument liegt in der Auswahl und Wiedergabe der historischen Fotos. Sie bilden neben den ebenso gut wiedergegebenen Aufnahmen jüngerer Zeit eine hervorragende Orientierung auch für den Modellbahner.

Schließlich sind auf ihnen viele beliebte Fahrzeuge zu sehen. Nicht abschließend zählen wir auf: Baureihe 012, 042, 38, 50, 65, 78, 93, 94, V 90, V 100, Steuerwagen VS 145, 216, 221, 515/815 oder auch 624.

Im Fazit ist dieses preisgünstige Buch nicht nur ein Muss für Bahnfreunde und Technikinteressierte mit regionalen Themen, sondern auch für alle Nichteisenbahnfreunde aus dieser Region.

Publishing pages with reference possibility:
<https://verlagshaus24.de/sutton>

1zu220-shop.de

Ihr Fachhändler im Netz
für die Spur Z

Exklusiv beim www.1zu220-shop.de

ArchiStories 404181 - Kirche 'St. Johannes Paul II

Den Namen des Jahrhundertpapstes trägt die neugotisch gestaltete Kirche 'St. Ioannes Paulus II.' Mächtig und schlicht wirkendes Sandsteinmauerwerk in Kombination mit feinsten gotischen Maßwerkfenstern zitiert einen weit verbreiteten Kirchenstil des 19. Jahrhunderts, der sowohl in ländlicher als auch in städtischer Umgebung häufig zu finden ist. Aufwendig erarbeitete Details wie vier feine Turmuhren, vollgravierte Dachflächen, Echtholztüren und Fensterflächen mit teilweise bunter Bleiverglasung bieten faszinierende Eindrücke. Das Wappen über dem Eingang sowie die Losung 'Totus Tuus' verweisen auf den Namenspatron, Papst Johannes Paul II.

Bausatz aus hochwertigem, durchgefärbtem Hartkarton. Abmessungen: ca. 105x55x114 (LxBxH in mm)



54,95€



Archistories 705141 - Dörpeder Wassermühle Archistories 706141 - Wassermühle im Kallental



Bausatz enthält einen Motor für den Antrieb des Mühlrades.

**49,90€
je Variante**



ArchiStories 128171 - Viadukt 'Altenbeken'

Viadukt kann sowohl ein- als auch zweispurig gebaut werden. Mit dem Erweiterungs-Set können Sie das Viadukt um zwei Bögen erweitern.



**Grundbausatz: 59,99€
Erweiterung: 39,99€**

ArchiStories 101161 - Stellwerk "Dörpede" ArchiStories 102161 - Stellwerk "Kallental"



32,95€ je Variante

Maße ca.: Länge 66mm, Breite 24mm, Höhe 45mm



ArchiStories 405171 - Kallentaler Hof ArchiStories 406171 - Dörpeder Hof



54,95€ je Variante

Zweiteiliges Set: Hofgebäude und Scheune.



Readers' letters and messages

Zetties and Trainini in Dialogue

Thank you for each letter to the editor and all the feedback that reaches us. Write us (contact details see imprint) - Trainini® lives from dialogue with you! Of course, this also applies to all suppliers in Z gauge, who would like to introduce innovations here. A representative image is our goal. Likewise, here we note any events or meetings with a significance to Z gauge reference, if we are informed in time.

Further information on the last issue:

The last issue of Trainini was again very interesting. In the article about the grassing of the railway embankment, the conversion of the Viessmann signals is briefly mentioned. Perhaps you could publish more detailed instructions in one of the next issues. Thank you very much.

Thomas Oblak, Amsterdam (Netherlands)

Answer from the editors: From our point of view, there is not much more to explain, and there is also a lack of meaningful photos for a separate article. Therefore, we hope to be able to help you with the following explanation.

With the main signal, the side panels of the drive must first be removed. These are two round, black painted sheet metal parts that have been pushed lengthwise into a base part. As long as the actuator is connected to the signal, they cannot be pushed upwards.

If the base (with signal) is carefully pushed upwards, the accessibility is improved. However, this must be done with great care, otherwise the thin strands that carry the current to the LED at the end of the mast could break off. The short length of these strands also limits the path. If the two shell parts of the drive cannot be pushed far enough upwards, we are looking for a way to grab them and lever them to the side in order to lead them out.

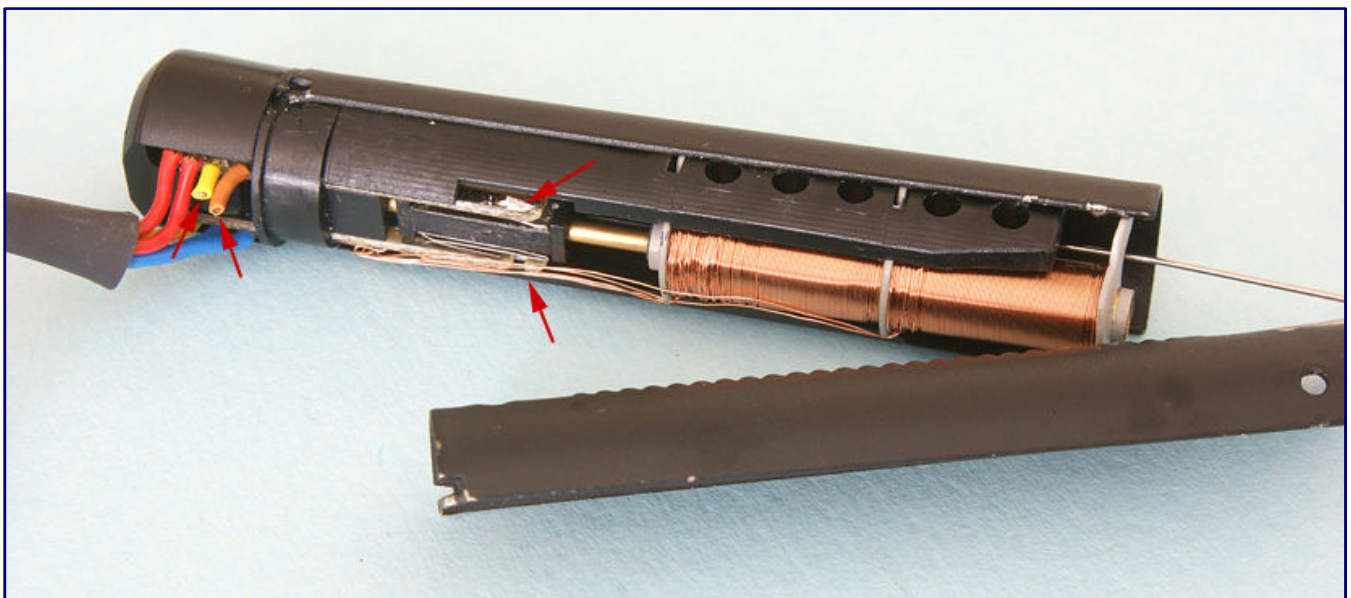

The four red arrows mark the separation points for stranded wire and cables inside the Viessmann signal drive. This is helpful if the signals are to be used on a diorama as an illuminated dummy or if the drive is to be converted to a servo, for example.

Once access to the cable feeds is opened from the signal, they are cut as close as possible to the drive. The same applies to the wires from the drive that lead to the bottom of the transformer. The drive can then be carefully removed from the signal socket.

In this step you have to make sure that the adjusting wire at the upper end of the signal is also pulled out of the plastic holder without disassembling the mechanics. Otherwise it would have to be reassembled with a lot of sensitivity, which experience has shown may not suit every model railroader.

Before the signal is installed as a luminous dummy at a new location, the loose ends of the strands have to be reconnected by soldering. The correct polarity should be determined beforehand with a measuring device due to the series resistor and diode or with the help of a transformer after provisional connection.

Interesting details about the new "Ludmilla" from a lover of this locomotive:

Interesting details about the new "Ludmilla" of a The Railion-Ludmilla 88135 is delivered some time. Now you can take another look at the older siblings and compare them with each other.

Rather inconspicuous on the underside we find now again the chassis of the 1st ICE-V-Triebkopf, which has the arrow (actually for the overhead line operation) in the other direction pointing.

The editions 88134 (BR 132 of the Deutsche Reichsbahn) and 81451 (BR 233 of the DB Bahnbau "Tiger") were the only ones to have the chassis of the 2nd ICE-V powerhead, but the ride quality is comparable with these recent editions and puts the first edition (BR 232 DB Cargo in the train set 81450) loosely in the shade.

At the front windows we find a real pressure progress. The window frames are now red and the windscreen wipers black. For the edition 88133 everything was black, which shows a front window bordered with rubber, for the edition 81450 the window frames were red, but the windshield wipers were not highlighted.



Our reader compared the Märklin 232 series models from the 88135 (left), 88133 (centre) and 81450 (right) packs and found the differences described. Photo: Torsten Scheithauer

Not quite so beautiful, but it is lost in the overall impression:

- Not quite so nice, but it works in the - The white ring in the porthole has not been applied since the 81450.
- The rain gutter of the locomotive should be traffic red, as also with 81450. The rain gutter of the new locomotive is grey however.

In the printing of the frame 81450 and 88135 are equal, only the 88133 looks a bit more economical here. It's also nice that with the 88135 for the first time a traffic red Ludmilla also carries square buffers, so a third face comes into the round of DB locomotives.

I'm curious whether Märklin will be able to conjure up more Ludmilla variants from the hat or whether there will be a dry spell. In my collection there would always be a place for a new Ludmilla. Relatively popular model engines, like the traffic red 234 292 (a main locomotive of the IC 118/119) or the 232 571, which is still equipped with old fans, still offer variants.

Torsten Scheithauer, by E-Mail

Only Märklin connects generations:

Following last year's campaign, in which Germany was looking for the Märklin treasure, the traditional Göppingen-based manufacturer came up with a new campaign running until 30 November 2018, which certainly has what it takes to go viral and inspire people and make them think.

The goal is the generation of parents and grandparents aged 40 and over with a high affinity for multimedia offers, which are to be reminded with a lot of emotionality of the communal experience of model railways that once united grandpa, father and son and founded a common hobby.



Photo: Märklin

The central element of the campaign is a two-and-a-half-minute advertising film, which so far can only be found on the Internet and cleverly interweaves memories, melancholy, waiting for Christmas, the great role model and the Märklin model railway into a story.

The central role for Märklin is played by a blue track H0 transformer, as many of today's fathers certainly know it from their own childhood. The final message is: Märklin connects generations.

In the credits, this film finally refers to the campaign page (<https://www.maerklin.de/gleis1>), where it can also be specifically accessed and viewed. Those who are interested, may register themselves there, in order to acquire in the starting package from this campaign with a price discount of 70,00 EUR.

The Tenderdampflok class 74 and two Donnerbüchsen are given an oval track layout and a mobile station 2. The action price of the packing is tempting, particularly regarding the equipment with a small mobile station instead of the usual remote control.

Already thought of a calendar for 2019?

Slowly the year 2018 is drawing to a close, as we can see not only from (chocolate) dominoes and gingerbread in the supermarkets. There are only two months left until Christmas and already one week later we are starting into the year 2019.

This is also the beginning of the new calendar year with which publishers have been courting their customers for a few weeks now. There is a choice of photo calendars with historical or current railway motifs, including very special country or route themes as well as, of course, various offerings exclusively related to model railways.

Among them we find colourful compilations as well as specific editions according to builder or theme. Not to be forgotten are photo calendars with trams, buses, tractors or other commercial vehicles.



For a brief introduction, we have again picked the calendar "Modellbahnen 2019" (order no. 5825 / ISBN 978-3-8446-5825-5) from EK-Verlag. 13 coloured, spiral-bound calendar sheets on art paper in the format 48.0 x 30.0 cm ensure every month for joy and a seasonally suitable motif.

The pictures alternate between scenic and more railway like scenes. In contrast to the edition two years ago, unfortunately no Z scale motifs have made it into the selection, but this will only bother a very few interested parties.

New items from Micro-Trains in October 2018:

The EMD SD40-2 now follows at MTL with two Union Pacific operating numbers (Art. No. 970 01 221 / - 222). This means that this topic is obviously gaining momentum now that the largest competitor in the American market is suffering from replenishment problems.

It's also already time for the 2018 Christmas car (548 00 120), a 51-foot refrigerated car with a house motif deviating on both sides in a wintry landscape, complemented by the mascot Micro-Mouse.





EMD SD40-2 "We will deliver" from Union Pacific (picture page 53 below), MTL Christmas wagon 2018 (picture above) and bulk wagon from Rock Island. All photos: Micro-Trains

The Heinz series is continued with a yellow wagon under number 2, bearing the company number HJHC 424 (518 00 640).

The Swift Live Stock Express 40-foot cattle wagons with opening doors are offered with two car numbers (520 00 261 / -262), which also applies to the open 33-foot bulk wagon with external struts and two discharge bars (534 00 091 / -092). They bear the addresses of Rock Island and an appealing blue turquoise coat of paint..

In Germany, MTL models can be purchased from Case-Hobbies (<http://case-hobbies.de>), among others.

The time comes for autumn fairs:

The first event on the agenda is Faszination Modellbau (<https://www.faszination-modellbau.de>) in Friedrichshafen, where ZFI has assumed responsibility for the Z-gauge. In this respect, the fair is definitely

also interesting for the Zetties, although we have not yet experienced the systems shown.

A visit to Cologne (<https://www.modellbahn-koeln.de>) in the middle of November should also be worthwhile for Zetties. The ZFI will also have a booth there measuring 8 x 10 meters, where several systems will be on display: A nostalgia system built in 1985 can be seen there for the first time, and the "Metal Luggage Railway" suitcase system will also appear there for the first time.

In the Altenbeken Report we reported about the museum station "Almstadt-Segeste" with shadow station for six train sets. In addition there is the dream loop module system by Gerhard Maurer with a part of the near distance between Heimbach/Nahe and Kornweiler from the railway line Saarbrücken - Mainz.

We would also like to take a look ahead to spring 2019: Faszination Modellbahn (<https://www.faszination-modellbahn.com>), the first public fair of the New Year, will move to Mannheim and open its doors from 15 to 17 March 2019.

From the point of view of the organisers, this trade fair location is ideal for trade visitors and families because of its transport connections to public transport, including rail, and its accessibility by car: the Maimarkt site is located directly next to the A 656 motorway, and there are plenty of parking spaces available for visitors.

And again a new product in the 1zu220-Shop:

Exclusively in the 1zu220-Shop (<https://www.1zu220-shop.de>) a further Archistories model appears in the coming weeks, with which the Kallental and Dörpede series are continued. It is a village church in the typical architectural style made of quarried natural stone.



The church "St. Johannes Paul II" (Art.-No. 404181) fits to the building series "Kallental" and "Dörpede". In addition to the fine sandstone masonry, it also impresses with partly coloured lead glazing. Photo: Archistories

The church "St. John Paul II" (Art. No. 404181) serves both building series and has a neo-Gothic design. The mighty and simple-looking sandstone masonry, combined with the finest Gothic tracery windows, cites a widespread 19th-century church style that can be found in both rural and urban surroundings.



Fully engraved roof surfaces, real wood doors and the slogan "Totus Tuus" above the entrance are further characteristics of the neo-Gothic church building. Photo: Archistories

The details that make this model so special are elaborate and numerous: Four fine tower clocks, fully engraved roof surfaces, real wood doors and window surfaces with partly coloured lead glazing offer equally fascinating images.

Above the entrance of the cathedral building, which is again made of dyed hard cardboard, there is a coat of arms and the slogan "Totus Tuus," which refer to the patron saint Pope John Paul II.

Autumn for Ladegut Küpper:

Autumn with load the remaining leaves of the trees are wrapped in red shades and they are also on the rails again, at least when it comes to Spur-Z-Ladegut Josephine Küpper (<https://spur-z-ladegut.de>).

The specialists from Aachen have rusty steel scrap both for Märk

lins open two-axle Omm 52 of the old construction (Art.-No. Z-182-2) and for the Eaos 106 (Z-183-2) in the assortment.

Useful seasonal novelties at Noch:

As every year in the meantime, the Christmas market is still being used for interesting seasonal novelties and targeted advertising campaigns.

Three Christmas trees of different sizes and heights of 5, 8 and 12 cm are interesting for Zetties. They are not snow-covered, but illuminated with yellow LEDs. The smallest specimen carries ten of them (art. no. 22111).

Small projects that are tackled spontaneously and completed quickly usually do not require large quantities of work equipment and supplies. This is still taken into account with the offering of a 25 ml bottle of "Modellwasser (model water) mini" (60876). In terms of properties and application, it is identical to the product that has been available for some time.

Under the motto “The forest is calling”, the Wangen based specialist is inviting dealers to an advertising campaign in which customers can win various prizes with a total value of EUR 1,000.00 in a tree lottery. The action runs only with participating dealers up to 6 January 2019.

The special offer goods from well-known trees of the regular catalogue programme have been newly compiled and, depending on the tree type and size, assembled into three to fifteen copies in “tree cubes” in blister packs. Each package offers a price advantage of 20% over the regular packs and includes a coupon for participation in the lottery.

And because order is half of life, there are also still empty storage boxes, each of which is combined into two copies of different sizes. The storage boxes “Colours & Adhesives” (08081; 250 / 750 ml) have a screw lid with sealing insert, the two copies “Scatter material, grass, gravel & small parts” (08083; 365 / 1,000 ml) have a simple clamping lid. Two labels for labelling are included with each package.

Browse through the new Conrad model railway catalogue:

In the last issue we had briefly referred to the appearance of the new Conrad model railway catalogue. In the meantime it has arrived and we had the opportunity to browse through it.

On the 324 pages you can also find some very interesting exclusive models for Zetties. Märklin produced the yellow designed beer refrigerator of the brewery Engel (Art.-No. 98153), while most of the exclusive products here are the MBZ products.

Here, for example, we found a wagon turntable (without a drive), a skimming system and transport boxes for rail loading. In the model are the overloading crane with drive and the gantry crane with loading gear.



Märklin deliveries in late summer:

Shortly before the beginning of the Christmas season there are again a few deliveries to report. The first is the container wagon Sgs 693 (Art.-No. 82662) of the Deutsche Bundesbahn in condition around 1992 (late epoch IV).



The loaded container wagon Sgs 693 of DB (Art. No. 82662) belongs to the late epoch IV with an operating condition around 1992.

It is loaded with two 20-foot containers from MSC and one of the same size from Hamburg Süd. It should be mentioned that this time the end walls of the transport containers are not printed with addresses. Also already available is the hardboard construction kit of the Kreuztal "Kn" (89601).

In addition, the diesel-hydraulic multi-purpose locomotive of the V 2000 series in its original condition from the first construction lot of Krauss-Maffei (88203) has also arrived at specialist dealers. We have presented the purple-red painted locomotive in detail in a separate article in this issue.

A very attractive model is the crease of the series 1103 (88414) in the blue colour with a continuous fan band of original design and a continuous rain gutter. The handle bar at the front is also correct.



The Nürnberger Messelok 110 365-4 of the Bundesbahn (88414) with its two-part warning triangle on the front is an interesting variant of the crease. And thanks to product updates, this model is technically state-of-the-art.

The model of the Nuremberg special locomotive 2018 was used by DB from the end of the sixties as a test object for an improved perception of rail vehicles in regular operation. It is correctly labelled for epoch IV and has a conspicuous warning triangle of angular lines on the front sides.

The only justifiable deviations from the original are the fairing buffers, but this is only noticeable from a few perspectives. Technically, the model has undergone ongoing product improvements, and, therefore, has the new bell-shaped armature motor, a split printed circuit board inside and direction-dependent peak lighting with maintenance-free light-emitting diodes. The switch-over screw for overhead line operation was moved inside.

A summer splash of colour on airport scenes:

Anyone who owns a modern facility and then travels by train to the airport will be delighted with the following spot of colour in the Herpa programme. Recently an Airbus A320 with the Austrian registration OE-IQD (Art.-No. 559157).



The Airbus A320 with the advertisement for “Eurowings Holidays” (Art. No. 559157) flies for the Austrian subsidiary of the low-cost airline in the Lufthansa Group. In comparison to earlier editions, the aircraft shows deviations in shape, which is also visible in the background in comparison to Borussia Dortmund’s “Team Airbus”.

This aircraft is on the road for the Austrian subsidiary of Eurowings, which is criticised for having been created only to reduce the wage level in this group of companies. The machine shows the fresh standard appearance of the resurrected Eurowings, supplemented by an advertising motif for the company’s own package tour programme “Eurowings Holidays”.



The holiday plane has been turned in the meantime and now rolls towards the runway. Not only does it present its equally appealing opposite side, but it also shows us its very striking satellite dome on the rear fuselage section.

The short- and medium-haul aircraft is not only one of the “volume models” of the European manufacturer, but also has overall dimensions that are extremely suitable for plant operation. In the Eurowings fleet, too, it currently represents the majority of aircraft with more than 50 units.

In the meantime, a large part of the fleet has been fitted with the striking satellite dome on the top of the fuselage, which also is included on this model (in comparison to the earlier Borussia Dortmund “Team Airbus”). It enables the use of WLAN on board.

News also at Bergswerk:

Marco Bergs, through its distribution Bergswerk (<https://www.bergswerk-modell.de>), has expanded its range with new high performance cyanoacrylate adhesives designed for fast and durable bonding of photoetched parts, as well as white metal and resin kits and castings.



The three new products include the cyanoacrylate-based white metal and resin adhesive and a matching filler, which are available immediately. Photo: Bergswerk (Marco Bergs)

These special adhesives are characterized by a high impact and tensile strength as well as an exceptionally high final strength, which was previously only achieved by soldered joints or epoxy resin bonding.

A high strength special filler is also available for reinforcing butt joints and adhesive grooves on the reverse side in thick layers, which hardens hard as stone immediately after contact with the adhesive. The individual products are as follows:

Residual flexible etched part adhesive, medium viscosity (Art. No.: 83108),
White metal and resin adhesive, medium viscosity (83102) and
fine crystalline cyanoacrylate filler (83109).

Out of the **Trainini** Index?

Axel Reimann (<http://www.ersatzteile-1zu220.de>) announced to withdraw from the model railway business and to let his spare parts distribution run out in the next years. Therefore, he no longer has an Adobe Acrobat Pro license, and cannot create the **Trainini** Index at the next turn of the year.

Therefore, we ask our readers if one of you own such a license and can take over the **Trainini** Index in the future? If you are interested, please contact the editorial staff using the contact details given in the imprint.

If no replacement can be found, we will no longer be able to offer the topic search function of the Trainini Index and will remove it from our website.

The latest news from American Z Line:

The EMD SD75i in nostalgic BNSF paintwork (art. no. 6106-1 / -2) is already sold out at the factory. The BNSF has now received the new chassis from 2014 as a reissue with the 2006 housing.



After such requests were addressed to AZL several times, the manufacturer decided to produce this locomotive. The modern chassis also features new bogies.

Die überarbeitete EMD SD75i der BNSF in Nostalgielackierung ist werksseitig bereits ausverkauft. Foto: AZL / *Ztrack*

The 40-foot long, 1937 covered AAR freight cars now run for the Atlantic Coast Line and are available individually (904301-1), as well as in pairs (904371-1), and four combinations (914301-1).

You will find further manufacturer photos of the current deliveries under <http://www.americanzline.com>.

Own catalogue of the Modellbahn-Union:

The complete range from our own production with models and accessories also for gauge Z is now available in the catalogue 2018 of Modellbahn Union / DM-Toys (<https://www.modellbahnunion.com>), which is now available.

ALAN update 1.2.6 from Toy-Tec:

Toy-Tec now offers an update of its control program to version 1.2.6. The focus was on better information and standardization of various dialogs as well as support of digital functions. Details can be found on the manufacturer's website (<https://toy-tec.de/>), we will only give a brief overview here:

- Support the programming mode of accessory decoders,
- Easier handling of programming of DCC decoders with higher operational reliability,
- Control of all functions of locomotive decoders and corrected symbol assignment,
- Control of accessory decoders via the digital traction current output, and
- Full support of digital exit signals.

There has also been a lot of movement on the inside. Not all optimizations are externally recognizable, but every user will be grateful for clear error messages.

Toy-Tec is currently dealing with analogue locomotives that have been fitted with a capacitor for interference suppression. If it tries to suppress the high-frequency PWM of ALAN, it will cause problems with the operation of this control and create higher currents.

Toy-Tec recommends the removal of such capacitors so that ALAN does not indicate a short circuit, but this can lead to the loss of a manufacturer's warranty or warranty claims for the rolling stock.

In a future ALAN version, a low-frequency control should therefore also be offered as a basic setting, which saves de-soldering but is no longer suitable for bell-type armature motors. The driving characteristics will be somewhat worse, but in return there will be no changes to the circuit boards of the models.

Herpa Wings novelties for the beginning of the year 2019:

Among the Herpa Wings new products in a scale of 1:200 for the beginning of 2019, we have identified the following layout compatible models for layouts based on European models:

Pan American World Airlines Boeing 707-320 "Intercontinental Jet Clipper" (Art. No. 556835-001),
Edelweiss Air Airbus A330-300 (558129-001),
French Air Force Lockheed Martin C-130J-30 Super Hercules (559522) und
Airbus A220-300 (ex Bombardier CS300) in factory paint (559515).



Fire-fighting vehicles do not always have to be red. For this reason, the Ziegler Z8 airfield fire-fighting vehicle will be available in a different colour at the beginning of 2019. (Art. No. 532921). Photo: Herpa

A further version of the Ziegler Z8 airfield fire engine in lime green (532921) is also available.

There is also a small selection of the simplified Snapfit models simulated in flight:

Turkish Airlines Airbus A321neo (612210) and
TAP Air Portugal Airbus A330-900neo (612227).

Dad, come and play! -- International Model Railway Day 2018:

In the period from 26 November to 2 December 2018, the International Model Railway Day is intended to bring small trains back into people's focus. On the first Sunday in Advent and the week before, trains in miniature format will be shown and exhibitions organised all over the world.

In addition to many clubs and other groups, model railway manufacturers are also using this occasion to inspire children and acquire customers for the future with them. This also includes the company Noch in Wangen, Germany, which will be offering an interactive discussion with the management on Friday, 30 November 2018.

Between 1:00 p.m. and 2:30 p.m., questions can be asked and answered in a live video on the Facebook platform. The aim is to give as many customers as possible the opportunity to address and discuss their special concerns, questions and wishes.

One day later, on Saturday, 1 December 2018, visitors to the Noch-Modellbau-Welt can expect special promotions and offers. From 10:00 a.m. to 3:00 p.m. all friends of the hobby will have the opportunity to create small winter scenes with Noch products together with children or friends.

On this day, the manufacturer grants a special offer discount of 10 % on its own products in its factory outlet. Further information on the event will be available at <https://www.noch.de> from mid-November.



Model Railroading Day

2. December

Imprint (Legal Information)

ISSN 2512-8035

Bibliographical information of the German National Library: The German National Library lists this publication in the German National Bibliography. Detailed bibliographic data and editions are available in the DNB catalogue at <https://portal.dnb.de>.

The publication of **Trainini Praxismagazin für Spurweite Z** including **Trainini German Magazine for Z Gauge** is voluntary and non-commercial. **Trainini Praxismagazin für Spurweite Z** does not seek revenue streams. This publication is subject exclusively to German law and justice.

Contributions identified by name reflect solely the personal opinion of the author. This is not necessarily identical with those of editors or publishers. Photos were taken, unless marked differently, by the editorial office.

Editors:

Holger Späing (Editor-in-chief)
Dirk Kuhlmann
Joachim Ritter

North America Correspondent:
Robert J. Kluz

English translations:
Alexander Hock, Christoph Maier, Martin Stercken

Further, volunteer work: Michael Etz (**Trainini Lokdoktor**), Bruno Kaiser, Sujin Ritter, Torsten Schubert, Hendrik J. Späing

Publisher and responsible person under German press law is Holger Späing, Am Rondell 119, 44319 Dortmund; Contact: Tel. +49 (0)231 95987867 or by E-Mail at [redaktion\(at\)trainini.de](mailto:redaktion(at)trainini.de).

Events & advertisements of third parties are free, but are subject to availability & recognizable Z gauge relevance. They appear separately from the editorial part at the sole responsibility of the advertiser. Priority is always given to ads from small series producers.

Letters to the editor must be submitted in writing by mail or e-mail to [leserbriefe\(at\)trainini.de](mailto:leserbriefe(at)trainini.de) stating the full name and address of the responsible reader and are always welcome. The publication remains reserved for the editors. The editors endeavour to always give a representative picture and therefore to consider every entry.

When submitting images, photos and drawings, the transmitter agrees with the publication and exempts the publisher of possible claims by third parties. This includes a future repetition in the magazine, annual video as well as in brochures & posters explicitly.

All company names, trademarks, and designations mentioned in this publication belong to their respective manufacturers or rights holders. Their reproduction takes place without guarantee of the free usability. The editors and publishers assume no liability for misprints, errors, price information, product designations, construction diagrams or transmission errors of any kind whatsoever.

Trainini Praxismagazin für Spurweite Z is published monthly (without guarantee) and is available to all interested model railroaders, especially friends of the Z Gauge, free of charge and for a limited time for download at <http://www.trainini.eu>. Download may incur third party connection and network service provider costs. Posting only the full magazine on other domains is expressly allowed after removal from your own pages, as long as the download is not offered for a fee.

All posts, photos and reports are subject to copyright. Translation, commercial printing and any other kind of reproduction, even in part, assume the prior explicit consent of the publisher. Especially unapproved, commercial exploitation will not be tolerated.

Trainini® is a registered trademark, registered in the register of the German Patent and Trademark Office (Munich), No 307 30 512. Brand owner is Holger Späing, Dortmund, Germany. Misuse will not be tolerated. All rights reserved.