

International Edition

Cost-free,
electronic magazine
for railroad enthusiasts
in the scale 1:220
and Prototype

Trainini

German Magazine for Z Gauge

www.trainini.eu

Appears monthly
no guarantee

ISSN 2512-8035



Museum railway at the water edge

Micro layout with a difference
Motor and digital technology

Introduction

Dear Readers,

when the sun is shining outside, and there are no clouds in the sky and we sweat in the shade at 30° C, then we are more drawn to a lake, an excavator hole or an outdoor pool, than to the hobby room.

Who thinks of the model railway in the middle of summer and not of holidays? Although there are only a few weeks separating us from the holiday season until the beginning of the next crafting season, we did not want to give up and have now tried to combine both.

So today we make an excursion to the German North Sea, more precisely to the north in East Frisia - at least in the model. Last year, the Museumseisenbahn Küstenbahn Ostfriesland e.V. celebrated its thirtieth anniversary and a representative of our editorial staff was present.

Our connections to this active association with a tourism focused concept for the preservation of historical materials go back much further, however, as you will quickly notice when reading. Nevertheless, it took more than fifteen years to turn a concrete idea and plan into a finished model. It does not matter to us that the original in its former form is long gone.

So travel with us into the recent past, let the sea wind blow up your nose, and enjoy a Doornkaat with us.

It was a great pleasure to read and hear how well our landscape series from last year was received. Our reader Christoph Maier decided on the nominal size Z for space reasons and gratefully took up our tips to use them for his first work.

The result surprised us so much that we wanted to share it with all readers. Today, he passes on his experience and self-critically analyses the unavoidable errors. Anyone seeking further advice is in good hands with our literature recommendations, which today are dedicated to the handling of paints and spraying equipment.

Rather, the obligatory program includes technical topics, on which we receive repeated feedback on how urgently many model railroaders need them for their projects and planning. This continues with the digital basic knowledge, which deals with other components that are likely to be used in a system.

We also found gaps in our knowledge of engine technology: What is the difference between the engines used by Märklin and those the manufacturer now likes to call high-performance drives? Alex Hock explains how the different types of drives work and describes their advantages and disadvantages.

Equipped in this way, I hope that much in the future will be more understandable, easier to handle and even more fun. We hope to have assembled a versatile edition for every taste and wish the entire editorial team a lot of fun reading - perhaps on well-deserved summer holidays!

Yours,

Holger Späing



Holger Späing
Editor-in-chief

Editorial

Introduction 2

Model

At home on the coast 4

Prototype

Currently no items

Design

An excursion to Tiny Village.....16

Technology

Sequencew of generations in motor technology26

The puzzle fits together.....40

Literature (not translated - only in German)

The right way to deal with colours50

Always dirty fantasies?52

News

Zetties and Trainini in Dialogue.....54

Imprint.....62

We thank Christoph Maier and Alex Hock for their articles.

Date of publication of the German language version of this issue: 25 July 2018

Cover photo:

The MKO museum train has stopped at Westerende, a small station on the East Frisian coastal railway. Behind the club's own V 60 062 hangs the Doornkaat car, a former DB Gos-uv 253. It transports cool drinks for sale to the accompanying tourists.

Doornkaat Wagon of the MKO e.V.

At home on the coast

Good things take time. Rarely is a proverb as true as in the wagon project presented today. Long before Dirk Kuhlmann dared to create coastal motifs, a Westphalian Z-scale group planned a wagon model whose prototype was at home in Ostfriesland. Finding a suitable partner for the required lettering was not easy, but today this project also presents itself in perfect form.

Our construction project to be presented today has a long history - on the prototype side as well as in the model. The foundation of the association Museumsbahn Küstenbahn Ostfriesland e.V. with the main focus of activity in the north represents the origin.

In the extreme northwest of Germany, where the ferries to Juist and Norderney leave in the district Norddeich Mole and the tracks of the Emsland line end, an active association came together in 1987 to preserve the heritage of the coastal railway.



This is condition of the MKO museum train during a visit to the north at the end of the 1990s. The Onno Behrends car was recently rebuilt with financial support from the tea company and also received a brakeman's cab according to Prussian drawings. This wagon will soon succeed the Doornkaat wagon.

The focus was on the remaining western section of this former Emden - Norden - Jever - Wilhelmshaven railway line. At this time only the section north - Hage - Dornum with a length of 17 km was preserved.

The aim was and is to preserve typical vehicles from the region and to make use of the tourist attractiveness in order to raise the necessary financial resources. This means that a historically correct representation of the original wagon is by no means always paramount, but rather the highest possible condition and an appealing appearance are foremost.

After all, this coastal region is a rural and idyllic area with sparsely populated areas. Large cities with sufficiently large commuter areas for high numbers of visitors are too far away. This is why the MKO is primarily aimed at tourists who are primarily looking for a lasting and enjoyable holiday experience and who like to combine a train ride with a bicycle tour.

And so, after the negotiations with the Deutsche Bundesbahn ("DB") (German Federal Railway) had been concluded, the MKO's first special trips took place on 6 and 7 June 1987. At that time, conversion and central entry carriages of the types Byg and Byl were used, pulled by the north station locomotive type Köf 2, but the first club-owned freight car of the type "Dresden," which is still in service today, was also included.



This covered car, which is labelled Dresden 80001, was an integral part of the museum train throughout the years. It can be reproduced based on a Märklin model without any modifications.

Other wagons followed, including the club's own conversions of four and three axles, which are now completely replaced by Donnerbüchsen. There have also been changes in the freight car fleet since then, but more on this later.

In the absence of its own diesel locomotives or for special trips, the MKO often had to make use of borrowed locomotives in its first years. These were a V 60 and also a V 100, which used to be at home in Ostfriesland, as well as the museum steam locomotive 78 468 which was already a guest in the north.

Today, the old red V 60 062 is a shunting diesel locomotive suitable for trackside use, which not only matches the cars and the area in excellent colour. However, it is not a locomotive from earlier DB stocks, even though it is now so painted and labelled.

This now creates a framework for creating museum trains close to prototype, which is largely possible with commercially available Märklin material, except for a very special wagon around which this article is supposed to revolve.

The Z-Friends NRW

When the MKO e.V. pursued its goal with great commitment and built up its own vehicle stock in the former Bw Norden, a group called Z-Freunde NRW (North Rhine-Westphalia) met every two months in Münster, Westphalia, to which around twenty Zetties, most of whom came from the Ruhr area, attended.

At the same time, a covered freight car of the type Gos-uv 253, last used in the express freight service of the Deutsche Bundesbahn, became available to the still young museum railway club. Thanks to its heating cable, it could also be included in passenger trains, and its maximum speed of 100 km/h also met the requirements.



Due to the colour cast of the old photographs, the Doornkaat car appears blue rather than green. Nevertheless, this photograph was an important document for the design of the planned model, as it shows the much better preserved, weather-resistant side of the model.

The MKO was able to take over this wagon and refurbish it. Thanks to a grant from the company Berentzen in Haselünne, this project could be completed and the car could be painted in a dark green. Provided with a red roof, it now bore the lettering "Doornkaat" on all four sides as well as illustrations of the striking square bottle on the long sides.

On the two sliding doors, a historical advertising motif of the former Norden's liquor trademark and its local distillery was also painted. With so much local colouring, the car received a general inspection in 1995 and entered the stock as Gos-253 with the company number MKO-022, and it immediately assumed a permanent role in the museum trains.

Because of its unique and appealing design, Z-Freunde NRW also became aware of it, which together had previously saved a Märklin advertising car and then commissioned it. In the meantime, a new restoration project was underway, and they were looking for a new role model for implementation.

After Era II, the focus was now on the time of the Deutsche Bundesbahn, but they remained on the MKO Doornkaat wagon. This seemed to be feasible on the basis of the Märklin 8605 model, and thus it offered

some variety from the previously customary advertising vehicles. However, it remained uncertain whether Märklin could also be won over for this project.

On the way to this goal, several steps ran in parallel: establishing contact with the MKO and clarifying questions about the templates as well as making their own photographs of the prototype, obtaining Märklin's order conditions and determining the budget, as well as obtaining approval for the necessary brand reproductions in dialogue with Berentzen.



The best colour impressions of the original are provided by this photo, which was taken from the sea side. In the upper part of the car body, the weather influences on the paint are particularly visible on the left, which should lead to the near end of the car in this design. Even from the former traffic red of the roof only a strong pink remains.

The project was facilitated by the focus on a non-commercial and purely private project. A sale of models was never planned at any time, which would have inevitably led to licensing costs.

Contrary to expectations, Berentzen quickly granted permission, but the advertising motif on the sliding doors in particular could not be supplied as a graphic. Here MKO was helpful, and they did not express any objections against producing a model of their wagon.

Meetings were arranged, a sufficient number of complete and detailed photographs were taken, on the basis of which the templates could be prepared later. In the meantime as we had already written in the year 2002, the original had already suffered badly from the rough sea air, a new coat of paint was inevitable, but for the association, not fundable.

In the meantime, another freight wagon was already being refurbished, which is still used today as a "tea wagon" to supply power to the museum train and also for cooling beverages in summer. This G 10 equipped with a brakeman's cab (again), provided with the advertising "Schwarzer Friese" by Onno Behrends, was later converted by Z-Freunde International e.V., as Märklin's annual car.

For their own club project this way should not prove however as the main goal. Nevertheless, there was great joy that the intact (and from the station invisible) eastern side of the Doornkaat wagon could be photographed for the project. The club had vacated the car especially for the photo shoot.

At first, all preparations were made, but Märklin withdrew as a partner, because the required number of pieces could not have been attained by the club, sale of models was excluded, and the focus was not primarily on collectors, either.

But a suitable partner was soon found in Belgium. Now it finally went ahead with the models and first drafts aroused enthusiasm for the planned model based on the base car, which would then only lack the brakeman's platform.

And yet further implementation came to a halt. The drafts were not followed by a release sample; finally, the Belgian partner withdrew from the joint project. In the club, many participants had lost interest in this special car, and so a cash check was made and the remaining funds were distributed to the members.

No other participant stuck to the idea in order to implement it in another way. Since the last photo shoot, 16 years have passed: the old round of group members have long since dissolved, and only a small number of them still meet at irregular intervals at different locations.



The historical Doornkaat advertising motif on the sliding doors, which could not be procured in an electronic form and threatened to become the price driver for the model implementation. By the way, a sliding door with this design has been preserved.



Today the wagon is on the road again under its old company number MKO-022, after being converted into a yellow construction wagon with the ostfriesische (East Frisian) flag as an ornamental ribbon on its long side. On this photo it can be seen in 2014 during a level crossing repair in Westerende. Photo: MKO e.V.

In the meantime, there are other affordable technologies to choose from, and his own skills did the rest. And so today we can present at this point the first Doornkaat wagon that emerged from the project outlined above.

Meanwhile, the prototype is no longer on the road in this design: in 2007, a Donnerbüchsen with the same company number was obtained and integrated into the museum train. However, the Gos-253 was by no means sold, but was refurbished and converted into a construction train car.

Today, the body encloses only two thirds of the loading area, the last third is a covered open area. It also received its old car number again and a ribbon in the colours of the East Frisian flag decorates the now yellow lacquer.

The model is created

As planned from the beginning, the basic model for the conversion was Märklin wagon (article number 8605); portions of a second, identical chassis provided the required extension for the brakeman's platform. In addition, a suitable brakeman's platform was required, which in this case came from a four-axle tank car, and it had to be adjusted after it was detached from the weight plate.

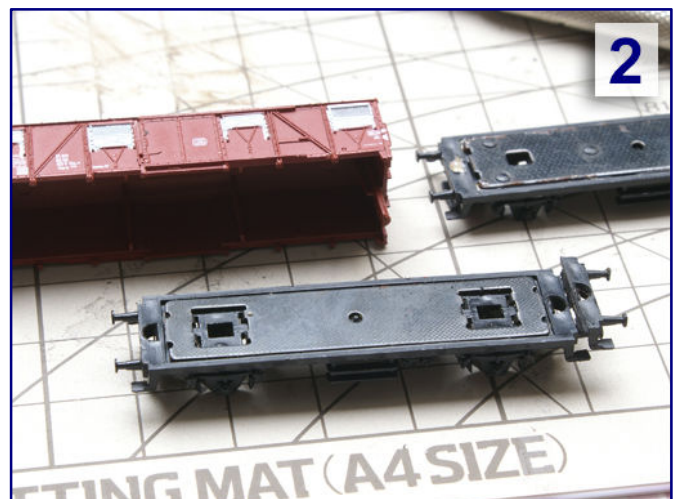
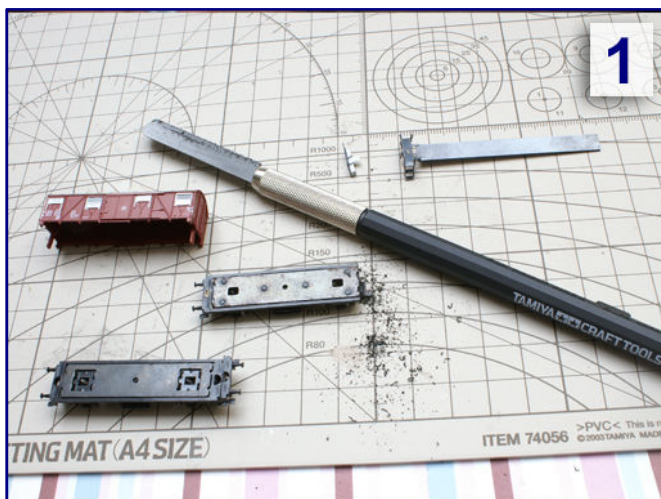

A second, identical chassis served as a source for the frame extension (Fig. 1). The part with the width of the brakeman's platform was cut off with the help of the Tamiya hand saw with their finest saw blades. Subsequently, a first fitting test of the extension was carried out on the running gear (Fig. 2).

This required several fitting samples with running gear, platform and superstructure. But first, the frame extension had to be done. The matching piece was cut to length with a “hand saw with handle” from Tamiya with finely etched, 0,15 mm thin saw blades (“Fine Craft Saw Blade III”) from a defective running gear in the junk box.

The above-mentioned fine saw was also well suited for removing the centrally positioned running boards, as they actually belong to a refrigerated truck, but not on this covered design. A prototypical replacement for these was later added to the superstructure.

At the later end of the body, manoeuvring steps and remains of the coupling box had to be removed. A fine boring grinder, equipped with dental polishing discs, was used. The parts were glued together with “Uhu Hartkunststoff” (hard plastic adhesive).

The new clutch box, which was required at the extension, provided additional stability: a component from FR Freudenreich Feinwerktechnik became available, because components and parts for in-house projects or FR models are now also available as kits. The new coupling box was also attached with Uhu's special adhesive.

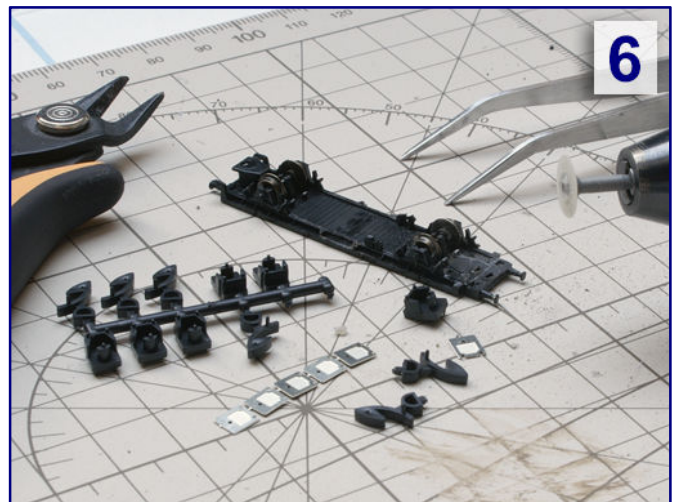
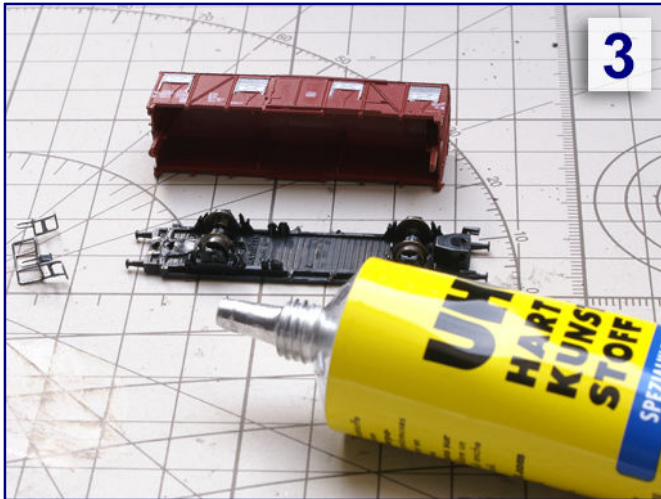

The frame extension has been glued on. Then the coupling box and the manoeuvring steps were roughly removed (Fig. 3). After drying, a sample was taken from a tank wagon with the intended brakeman's platform to determine the parts to be separated (Fig. 5). Finally, the underside of the chassis floor was smoothed (Fig. 5) so that a new coupling box with FR individual parts (Fig. 6) could be attached.

The system couplings should also be replaced, since Märklin's specimens are made of the non-sticky plastic PMO, whereas those from Freudenreich are made of polystyrene, which is easier to process.

The reason for this exchange action was the desire for train separation with the help of a Jörger uncoupler. For this purpose, a piece of magnetisable metal, such as a part of a staple, was glued to the underside of each coupling shear. So that this did not attract too much attention, it was later painted black.

The chassis with the platform railing was also primed in black, from an angle at the top, so that no paint enters the wheel bearings and coupling boxes. The black spray primer from Modelmates was used, which dries up very matt, but unfortunately is no longer available.

Thus it went to the adjustments of the construction. It could remain largely unchanged in its form and therefore received only a few mechanical processes. One of the exceptions was the shortening of one of the two melting cones, of which only a tiny portion was left.

This remaining part was later used to guide the housing on the chassis, because the counter opening was also present and would only affect the underside of the new coupling box. This was also a perfect glue point for a permanent hold of the case on the platform end.

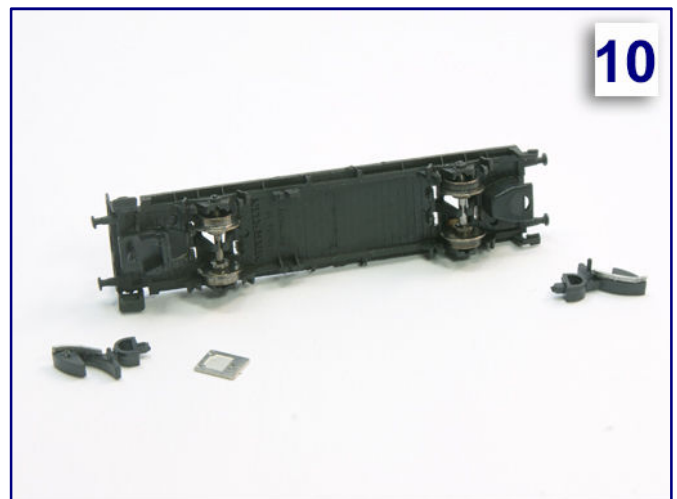

With the tampon printing remover from Prehm Modellbahn, the printed company addresses can be easily removed (Fig. 7). However, before the new colouring could take place, the step on the sliding doors had to be reconstructed from the etching ladders of C-M-K and glued on to the model (Fig. 9). After priming and painting, the body was largely finished (Fig. 9). In order to be able to uncouple the wagon later using Jörger magnets, the scissors were exchanged for polystyrene copies of FR, on the underside of which metal strips had to be glued (Fig. 10).

The body was then prepared for painting. First, the factory-made inscription imprints had to be removed, otherwise, they could later appear as raised letters on the body. The tampon printing remover from the garden railway specialist Prehm Modellbahn did a good job here. Applied with a micro-brush, it was allowed to react briefly until the printed letters could be wiped off.

Now it was time to apply the only change in shape of the body: On the side of the locking lever below the sliding door there is a narrow step, which Märklin also replicates in its later versions.

We still had to reach for our own construction and used an etched brass ladder (Art.-No. 5050) from the program of Creativ-Modellbau Klingenhöfer. A suitably cut piece ideally replicates the step. We bent the open end at right angles and drilled two holes in the car body, in which the ends were fixed with Uhu Super "Strong & Safe" All Purpose Adhesive.



The decals came from Andreas Nothaft, the Doornkaat bottle on the right side of the car had to be cut off just below the neck, because the ventilation slide on the model was reproduced open (picture above). For the FR couplings we used the softer compression springs from Micro-Trains (picture below).

After drying, a uniform, neutral base colour followed. Again we used a Modelmates spray can product, but this time in light grey. Later followed the final painting of the body, for which we used RAL 6028 pine green from Oesling-Modellbau in satin finish.

The roof had been previously spray painted in traffic red (RAL 3020). This is recommended because it was easier than masking the side walls and therefore faster completion could be achieved. It is always important to choose the right material: Masking tape should adhere well in order to protect against the paint, but on the other hand, it must not damage any paint on the model when it is removed.

We have had the best experiences in this respect with Tamiya products, which are available in various widths from Conrad Electronic and others. The new lettering, on the other hand, came from Andreas Nothaft Modellbahndecals and represents decals that are soaked in water and then slid onto the model from the carrier paper.



Like its model, the model also received the trademarks on both front sides, shown here at the end (without platform). The golden shadows of the Doornkaat lettering, on the other hand, are barely visible in this scale.

For best results, the substrate should be moistened beforehand with an adhesive fixer; the applied decal was then drizzled with a softener and left in peace overnight. The foil, which can easily be damaged in this condition, then flowed around virtually all edges and structures. Both liquids were supplied by Agama from Bergswerks.

This step could also be completed with the subsequent clear coat sealing; the model could be touched without hesitation after the matt protective layer had dried. So it was time to “marry” the chassis and superstructure. This was initially done on a trial basis before the compression spring and coupling were introduced at the end of the car without a platform in order to finally join the two halves.

Since we had already replaced the couplings, as described above, the Märklin compression springs were no longer used. Freundreich prefers those of Micro Trains because they are softer. As they fit perfectly into its couplings, we also used these parts.



The MKO museum train is on its way: A rented 212 takes the train through the East Frisian landscape (top photo), at the stop in Westerende (bottom photo) the club's own V 60 062 runs the train consisting of three-axle and four-axle conversion wagons.

At the end of the car and in the middle of the wagon, some hard plastic adhesive from Uhu was used, on the opposite side there was sufficient hold as soon as the coupling pin was melted, which also served as coupler guide, was widened with a soldering iron tip. Below the brakeman's platform, the FR coupling hook also required some heat, as the etched cover plate is also held in position by three melting points.

Finally, after a lot of time and work, the little dream became reality. Thanks to suitable facilities and driving dioramas to North Sea motives it should not cause any problem to bring the Doornkaat car alias MKO-022 together with the museum train on the journey through the miniature world at the turn of the millennium.

Manufacturer of the basic model:

<https://www.maerklin.de>

Suppliers of the working materials used:

<https://www.bergswerk-modell.de>

<http://www.fr-model.de>

<http://www.klingenhoefer.com>

<https://www.micro-trains.com>

<http://www.modellbahndecals.de>

<http://www.oesling-modellbau.com>

<http://www.prehm-modellbahn.de>

<http://www.tamiya.de>

<https://www.uhu.de/de>

Further information on the museum railway:

<http://www.mkoev.de>

Z. Scale. Hobo by ARCHISTORIES®

USA-Type Train Station 'Goldtree' · Z Scale
A world-wide *exclusive* offering from Z.Scale.Hobo, USA



City Side

Track Side

www.zscalehobo.com · +1(949)981-7643

Inspired by a small layout

An excursion to Tiny Village

Our reader Christoph Maier came to the Z-gauge for space reasons after the passion for model railways was reawakened. Inspired by the small radii of Rokuhan and also inspired by the instructions from our theme of the year 2017, we created a debut work which impressed us deeply and which probably only its author himself is able to find shortcomings. Today he reports here about his experiences.

By Christoph Maier. For some years now, my hobby has been aquaristics, which deals with the design of moving micro-worlds using technical means, and is therefore not entirely unlike railway model making.

The model railway was then added about two and a half years ago, triggered by the annual Christmas visit to my parents, during which my brothers and I took the Märklin H0 stock from our modest carpet railway career from the store during childhood and youth for the first time in more than thirty years and brought it back to life under the Christmas tree.



Winzlingen (Tiny Village), opened up by a small branch line, is located in southern Germany. This layout includes a landscape of hills.

Many memories arose again along with the desire to take a closer look at the topic. It quickly became clear, however, that even a permanent H0-gauge system of compact dimensions would not be possible for reasons of space.

So after some research, I quickly ended up in Z scale, which, at least at my current level of ambition, takes up little space, can easily be stowed away in a cupboard, and with which it can sometimes also be tinkered



The branch line was not closed down longer than elsewhere. The quite heavy school traffic justifies the use of two-part rail bus sets to this day.

and played with on the living room table in the family circle in the evenings in a halfway “socially acceptable manner”.

A first attempt in Z gauge was made with a small prefabricated layout, but was quickly put back on track. Looking back, the main reason for the task was that I didn't have a personal history with the layout, and therefore lost motivation for this project.

But then I continued to browse in a lot of relevant forums and trade journals, played with layout designs in my head, discarded them again, and at the same time gradually built up a small basic stock of rolling stock, kits, tools and landscaping materials.

At some point I came across photos of a small Japanese N-gauge system on the Internet, which immediately appealed to me, since it seemed to offer everything that I was looking for as a first project: a small rail oval with two railway station tracks, which attractively combined some classic landscaping themes - rocks, roads, water - and promised to be somewhat easy and quick to construct.

to the edge of the installation and the curved road running transversely optically enhance the otherwise simple oval.

I also found the layout visually very appealing. In my opinion, the slightly diagonal rotation of the oval of the track in relation

In my mind, the Far Eastern design was then quickly transported to rural German regions. In addition, there was a small frame story all by itself, which combined some blurry childhood memories and motivated me to carry the project through to its completion.

There were trips with the Uerdinger rail bus through the surroundings of my southern German hometown, bicycle tours to the excavator lake, family excursions to countless hill tombs and other historical sites (my father was a history teacher), as well as steam locomotive rides in the late seventies on the Sauschwänzlebahn in the southern Black Forest.

The project name Winzlingen (Tiny Village) was also clear from the very beginning. It may be a bit silly, but for me he describes in one word what it is about: a micro system in Z-gauge, which suggests a regional reference to my southern German homeland through its place name ending.

The story of Winzlingen

Winzlingen is a small place somewhere in western Germany, in the early or mid-eighties. Today a structurally weak region; agriculture, two or three small businesses and several craftsmen still fed their husbands well during this period.



On the weekends, Winzlingen is also a popular attraction for summer visitors because of the nearby quarry ponds.

Winzlingen station is a little outside of town on the connecting road to Unterwinzlingen, but can be reached quickly by bicycle or bus. Because the last baby boomers are aiming for secondary schools in the district town 20 km away, rail bus traffic on the small side line is quite busy.

On weekends, the area is a popular excursion destination because of its quarry ponds. There is also a Neolithic burial mound on a nearby hill, popular with hikers and school classes.



The inhabitants are proud of a heritage of supraregional importance in the form of a Neolithic hill ridge. It also makes the place a popular destination for hikers.

Local people have always been proud of this nationally significant historical heritage, even though the rich burial supplements have been in the far-flung Archaeological State Museum since the excavations in the 19th century.

The new museum railway now also provides additional operation. The steam age of the Deutsche Bundesbahn dated back only a few years, and thanks to a handful of alert enthusiasts of IG WinZdampf e.V., some well-preserved gems from an epoch that has now finally passed are regularly used from spring to autumn. All appearances and illusions are fed by some fuzzy youth memories...

The construction of the micro layout

Construction began in June 2017 and the work lasted until the beginning of July this year with many smaller and a few larger interruptions (although there's still plenty I could do here and there). I mainly worked at the kitchen or living room table, in good weather also in the garden.



The reception building at Winzlingen can be found in Faller's programme as a laser cut kit "Bahnhof Osterode" to match the motif.

The small station, which is the Faller "Osterode-Süd" laser cut kit, was the first to be built. It was my first encounter with a laser cut kit and the corresponding construction report from the **Trainini®** issue 6/2016 provided valuable assistance. The roof was slightly aged with powder paint, but due to a lack of experience and the fear of "messing up", I did not dare to age the walls.



Next was the layout itself. The layout base (in this case a big word) consists of a simple wooden box with the dimensions 3 x 30 x 50 cm. Length and width also describe the base area of the system.

Materials and design

Base unit

Plywood box for artists 3 x 30 x 50 cm

Landscaping

Foamed cardboard plates (1,5/3/5mm), Styrodur 2,5 cm, ready-made filler

Track system

Rokuhan

Ballast, ballast glue and track weathering

Koemo

Greenery, grass and trees

Avantgarde-Modellbau, Miniatuur Silhouette, Woodland Scenics, WWS Scenic Manufacturer

Buildings

Faller, MBZ

Lattice mast luminaires and traffic signs

HOS-Modellbahntechnik, Märklin

Figures and Details

Preiser, Rolfs Laedchen, Trafofuchs, Kit-bashing

Vehicles

Märklin, MO-Miniatur, Trafofuchs, Wespe, 1-zu-220 Shop

Background

Modellbau-Atelier Andreas Dietrich

The sides of the box were covered with painter's tape to protect the untreated wood from soiling during construction. Two layers of 5 mm thick foam cardboard were then glued to the surface of the box.

The tracks were then laid, but not fixed in place. The choice fell on the Rokuhan track system, because this manufacturer has the curved tracks with a radius of 120 mm required for the implementation of the track layout, and also short switches with a likewise narrow radius in its range.

Its stop switch function allows analogue operation with two trains in a simple way, without the need to create electrical blocks and make additional track current connections.

Of course I knew from the beginning that with the chosen narrow radii only a very limited operation would be possible. Basically, it is not a fully-fledged complex, but rather a drivable diorama with a roundabout.

After assembling the tracks I aligned the oval and after cutting out maintenance holes under the turnouts and a hole for the power cable I glued it directly to the foam board surface with superglue.

Care should be taken to ensure that all tracks, especially in the curves, lie flat and that the track connections resulted in smooth rail joints.

After the tracks had been glued down, the track areas in the station area were covered with suitably cut foam backed cardboard pieces of 3 mm thickness.

Other areas inside the oval were also raised with the same material.

I built the station forecourt, the platform and the street with foam backed cardboard, but this time in 1.5 mm thickness.

In addition, narrow foam clay strips of 1.5 mm thickness were attached laterally to all track bodies outside the station area in order to create a natural-looking track bed profile later when ballasting.

I made the first rough design of the terrain and the cut-out for the lake with a sharp handicraft knife. In addition, the colour treatment and ballasting of the tracks was done.



Scene from the construction phase: The complex has retained its essential structures, but vehicles, signs, figures and a large part of the vegetation are still missing.

Paints, adhesives and gravel from the firm Koemo were used. These works required a certain patience and increased caution around the switches, but were not witchcraft and in my opinion contribute quite considerably to a more natural overall aspect. However, it is important that a sufficiently fine and true-to-scale ballast is used.



This overhead view provides an overall of the layout structure and its finished condition. Even the tilting of the oval of the track to the edge of the installation provides a considerable part of the extremely convincing effect.

The next step was to design further landscape structures. The rocks were made of 2.5 cm thick Styrodur panels from the DIY store. They were roughly cut with a knife and the rock structures were then worked out with a sharp handicraft knife and the fingernail.

Afterwards I painted over everything with diluted Moltofill finishing putty and after drying I treated it with several layers of paint and finally granulated it. At the beginning I was quite satisfied with the result, but subsequently I would take more time in the rock design, use other methods and strive for a more natural appearance.

The lake was created using the rough fibre method described by Dirk Kuhlmann in **Trainini®** 4/2017. Easy to implement and resulting in an astonishingly realistic water effect, but for the replica of a normally calm dredged lake, perhaps not the most suitable technique for Z gauge. Nevertheless, I just wanted to try it, and I am quite satisfied with the result.

In terms of surface design and landscaping, I have also strongly oriented myself to the techniques and materials described in the **Trainini®**-series on landscape design last year. Only “oriented” because I have omitted some steps and details here and there in a hurry, which can partly be seen in the result.



A view of the station forecourt: As was customary at that time, a telephone booth is simply part of it and is also used well. Meanwhile, the intercity bus is waiting for passengers to leave the rail bus and continue their journey to Unterwinzlingen.

Basically I followed the concept of a multi-layer substructure of fine grained gravel, sand and earth (the latter from my own garden), followed by a first basic planting of fine-turf from Woodland Scenics.

The one mistake I made was to sprinkle the turf directly onto the layout and not through a fine sieve. This means that, at least from a macro perspective, the grass does not always match the 1:220 scale.

When it came to grass, I hesitated for a while whether I should apply grass fibres at all or continue working with different types of turf and foliage. I finally invested in a small static grass applier and did not regret it.

The bushes were created using the steel wool method described in **Trainini®** 11/2017, which produces fantastic results quickly and simply with little practice. I have also tried my hand at tree building using the techniques also shown very vividly in **Trainini®**, and found that this is not witchcraft either.

However, it would have taken me more time, patience and practice for really convincing trees than I could have made myself. I therefore used the very beautiful trees of Avantgarde-Modellbau, but I would like to try building my own trees in the future.



A rural idyllic scene can also be seen at the level crossing of the Landstraße (main road), which affects Winzlingen train station. On the roof of the transformer house a pair of storks has built their nest. The wet meadows around the excavator holes provide sufficient food for the feathered offspring.

For the further design and detailing I used the amazingly rich and fine ranges of different small series manufacturers (see list). Here, too, meetings and tips in **Trainini®** and Internet forums, especially the ZFI, were very helpful in hunting down small details, particularly since I only knew the large manufacturers with their limited range at the beginning of my Z gauge project.

A few details were also self-made. A magnifying lamp and magnifying glasses were indispensable aids for the fine details. Finally, I gave the installation a backdrop. At first I had thought of a self-made backdrop, but then I bought a photo backdrop that fits very well into the system.

Conclusion and outlook

Meanwhile the tiny project is largely finished for me, even if some details will be added here and there. The construction of this small layout was a lot of fun for me and I am very satisfied with the overall result.

However, there are also some things I could have done differently and better. I have already mentioned the rock design, which for me is still not quite satisfactory, the high swell on the quarry lake and some shortcomings in the area design and landscaping.

In addition, the road of 3 cm (= 6.60 m) is probably a bit too wide for a rural local connection road. In addition, the rust tinting of the track ballast should have been somewhat more restrained. And also the colouring of the street and the station forecourt doesn't really satisfy me. The unbiased observer may find further issues.



The museum operation of the "IG WinZdampf" also has a permanent role, since the scheduled use of steam locomotives had been discontinued by the DB. Among other things, the museum railroaders use a Series 64 tank locomotive on the line.

Besides, I don't want to conceal that there are some things that bother me after this first experience with the Z gauge and that occasionally make me jealous of the larger gauges. On the one hand, this includes the limited range of building kits and equipment details compared to the larger gauges, although there seems to be a lot going on here and in recent times, especially by the small series manufacturers.

But the big gaps in the rolling stock are a major annoyance for me. Why, for example, is there not a single modern railcar like the Regio-Shuttle from Märklin? And why is the offer for road vehicles, especially passenger cars, so thin and generally not visually convincing?

Overall, however, I have to say that the 1:220 scale is very appealing to me. Nowhere else is there so much landscape per square centimetre - in the H0 gauge, Winzlingen would have a footprint of 75 x 126

cm. And with a little planning, care and the right materials, it is possible to achieve the same degree of realism as with the larger gauges.



The next layout project is therefore already in the planning stage. It will probably be a small oval again, with siding and a small shadow station behind the scenery, but this time with a larger track radius, a tunnel, bridges and a small river. I'm looking forward to it.

All Photos: Christoph Maier

Selection of manufacturers for layout construction:

- <http://www.atelier-dietrich.at>
- <https://www.avantgarde-modellbau.de>
- <https://www.faller.de>
- <http://www.hos-modellbahntechnik.de>
- <https://www.koemo.de>
- <https://www.maerklin.de>
- <https://www.mbz-modellbahnzubehoer.de>
- <https://www.mininatur.de>
- <https://www.mo-miniatur.com>
- <http://www.rokuhan.de>
- <http://www.trafofuchs.de>

Link to the idea donor (Spur N):

- <http://www.yutaatelier.com/NHKvol1.htm>

Comparison of electric motor versions

Sequence of generations in motor technology

For many years from 1972 Märklin used three-pole iron armature motors for Mini-Club. They were replaced by five-pole iron armature motors in slightly varied designs. The mass of customers was made aware of the alternative bell-type armature motor with the market entry of Rokuhan. With the V 36, Märklin finally started a technological shift. Based on part 1 of our digital series, our author Alexander Hock explains the function and basics of the different motor types including their advantages and disadvantages.

By Alexander Hock. For many years the Z-gauge world was divided: Märklin used three pole iron armature motors and later five-pole iron armature motors, while almost all other manufacturers used bell-type armature motors. Only with the appearance of Rokuhan as a high-volume manufacturer with their 181² series, which directly competed in Germany, Märklin also made visible efforts.



It was not until the 181² series from Rokuhan that the bell-type armature motor was introduced into the models of the high-volume series for the German market. In the meantime, it has also become the new standard drive at Märklin. Photo: Noch

Currently, this manufacturer appears to convert all locomotive series successively to its new engine generation. These are now bell-type armature motors as with the other suppliers. This article should

therefore help the reader to understand the general functioning of electric motors and to recognize the advantages and disadvantages of the various motors. The article goes step by step from basics into details.

Some physical basics

Current: $I = U/R$; if we apply a voltage to an electrical resistor, an electrical current flows. The technical current direction is defined from plus to minus.

The current across the resistor increases as the voltage increases or the resistance decreases. The maximum current is reached when the voltage source can no longer hold the voltage.

Torque: $M = F \cdot r$; if we pull on a lever arm with a force, a torque is generated. If the lever arm is attached to an axle, the force can be transmitted. The formula $F_1 \cdot r = M = F_2 \cdot r$ applies.

If we solve the equation for F_2 , we get $F_2 = (F_1 \cdot r) / r_2$. This means that a small force can be increased when it acts on a long lever arm - as shown in the picture. That is why freight locomotives have smaller wheel diameters than express locomotives.

If the wheels rotate at the same rotational speed, the wheel with the larger diameter covers a larger distance per unit of time, so the locomotive moves faster. But the locomotive with the smaller wheel diameter can transmit more power.

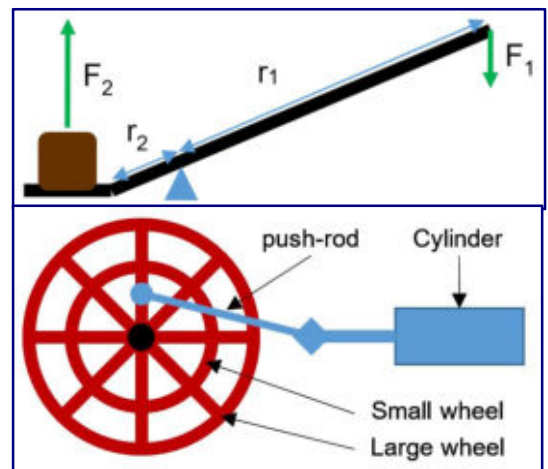

Magnets: Some materials have a magnetic effect. Inside the material there are lots of small magnets called dipoles or elementary magnets. If we expose them to a magnetic field, the dipoles are aligned so that all plus and minus poles point in the same direction like compass needles.

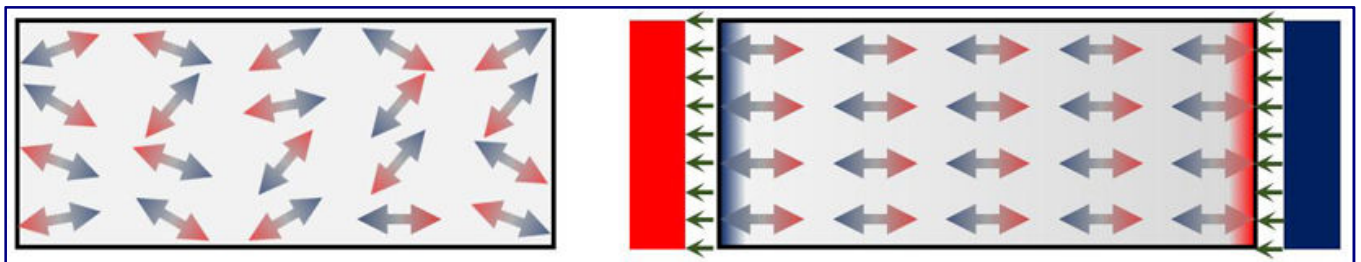

This makes the material magnetic and forms two poles, a north and south pole. Usually the north pole is shown in blue and the south pole in red. Magnetic field lines run from one pole to the other, shown in blue in the right picture. These act on other magnets in such a way that the unequal poles - i.e. north and south poles - attract each other and equal poles repel each other. Magnets lose their magnetic effect over time and can also be reversed polarity when exposed to a magnetic field.

Permanent magnet: To produce a permanent magnet, a suitable material is heated and exposed to a strong magnetic field to align the dipoles. When cooling down, the dipoles "freeze", so they can no longer change direction and the magnetic characteristics retained by the material as long as it is not reheated.

Solenoid: If we wind up an electrical conductor in a helix, a coil is created. When current flows through this coil, a magnetic field is created. If magnetisable material is now pushed into the coil, the dipoles align themselves in it and form a magnet.

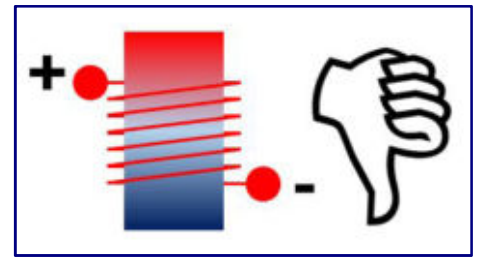

Since this magnet is generated by electrical energy, it is called a solenoid. If we reverse the current through the coil, the magnetic poles are also reversed. If we now imagine that we hold the coil with our right hand so that the fingertips point to minus, the north pole of the magnet will be at the end to which the thumb points.

Magnetic flux: Just like water or electricity, there is also a magnetic flux. However, there are no particles flowing from a source to a sink as with water or electricity - at least so far none have been found - but field lines. These flow from the north pole to the south pole. As with current, there are also better and worse conducting materials for field lines. Metals that contain iron are good magnetic conductors, air is a bad conductor. The field lines choose the path of least resistance. Here is a model:

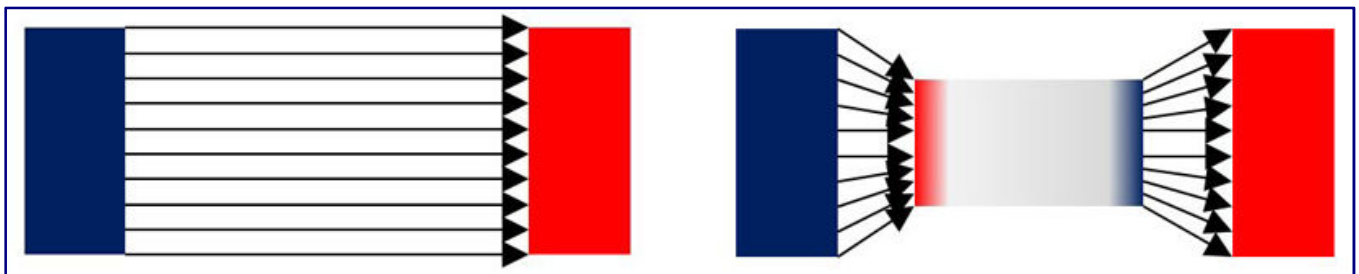

In the left picture, the field lines run parallel from the north to the south pole through air. The right picture shows a magnetically conductive object in the magnetic field. The dipoles in the conductor align themselves in the magnetic field, generate a magnet and reduce the resistance by shortening the path of the field lines through the air. If a rotating magnetic object is in the magnetic field, it will rotate so that the field lines must overcome the slightest resistance, just like the object in the right image.

Lorentz force: Up to now, the effect of the magnetic field has only been explained by attraction/rejection of the poles and the course of the field lines. If this sufficient you may skip the section "Lorentz force", because here the physical background is examined in more detail. In physics we like to capture effects in formulas and therefore the descriptive view is not sufficient.

When a charged particle moves through a magnetic field, it experiences a force. This force is zero when the particle moves along the magnetic field lines and maximum when it moves perpendicular to the magnetic field lines. This force is called Lorentz force (F_L) and acts perpendicular to the magnetic field lines and the direction of movement of the particle.

A well-known application of this principle is the CRT television, in which electrons - i.e. charged particles - are deflected by magnetic fields in such a way that they strike at different points on the screen and generate light points.

If current flows through a wire, electrical charges move through it. If this wire is in a magnetic field, it experiences a Lorentz force. This is exactly what happens in the electric motor and the force gives the motor a torque and a direction of rotation.

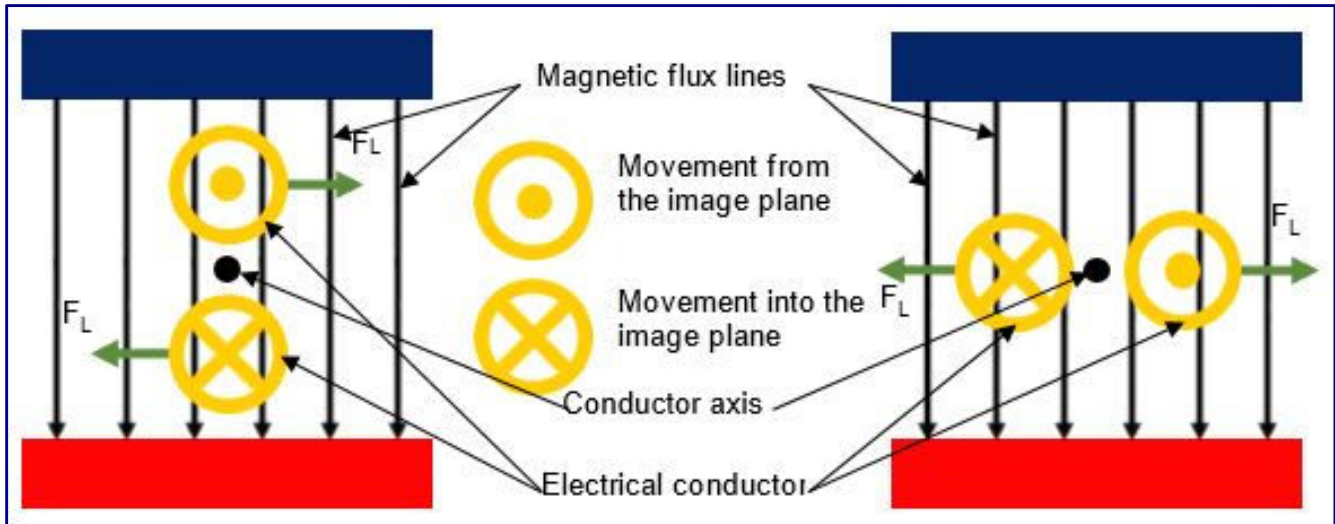

The left picture shows a section through a rotatable electrical conductor loop in a magnetic field. The magnetic field lines flow from the north pole to the south pole. In the conductor loop, in the upper conductor section the current flows from the image plane towards us, and away from us into the image plane in the lower conductor section.

In both cases the current flows perpendicular to the magnetic field and Lorentz forces are generated, up to the right, down to the left (green arrows). The conductor loop will rotate in the magnetic field until the forces are balanced. Then the loop is horizontal and equal forces pull to the left and right as shown in the right picture. The Lorentz force can be calculated and thus also the torque.

A conductor loop is the simplest form of a coil. From the rule with the right thumb we know that in the left picture a south pole would form to the left of the conductor loop and a north pole to the right. Since the coil is pivoted, it will align itself so that its north pole points to the south pole of the permanent magnet and vice versa, as shown in the right picture.

Thus we have two models to understand the movement of a coil in the magnetic field, the physical with the Lorentz force and the descriptive with the attraction of the opposite poles. Both are equal, as we have just learned.

The role of commutator and brushes

To rotate and keep a conductor loop or coil moving in a magnetic field, its poles must always be reversed when they are aligned in the magnetic field. For this we use a "pole inverter", the so-called commutator. On the one hand, it is supplied with current by electrical sliding contacts - so-called brushes. On the other hand, it is always connected to at least one coil in a magnetic field. The current through the coil generates magnetic poles and the coil rotates in the magnetic field as the north and south poles attract and as the Lorentz forces act. If we turn the current through the coils, we also turn the poles: the coil will reverse its position.

Functionality the electric motors

Electric motors convert electrical energy into rotary motion and are divided into DC and AC motors. Alternating current is a wave-shaped current (see article "High voltage or highly exciting?" in **Trainini®** 4/2018) that changes its direction of flow with a frequency, e.g. the current from the socket.

Direct current has a positive and a negative pole and always flows in the same direction, as we know from batteries. Since Z scale is only operated with direct current, AC motors are not considered here.

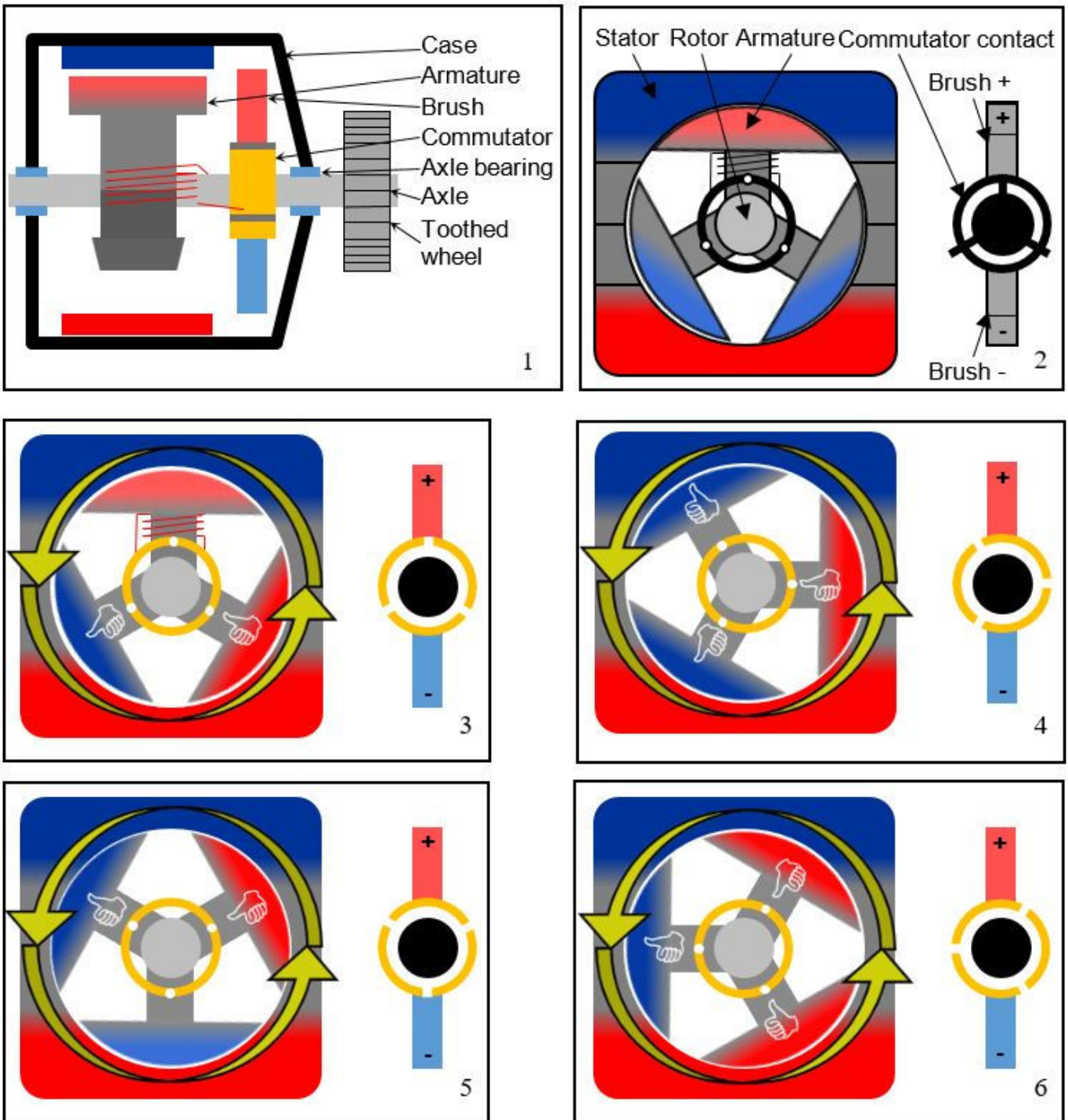

The DC motor consists of a fixed part (stator) and a rotatable part (rotor). The rotor rotates in or around the stator and is connected to a commutator via an axis. A current is supplied to the commutator via the brushes, which it reverses according to its position. An iron armature motor such as the Märklin three-pole was chosen as an example:

Figure 1* shows the motor in longitudinal section. The stator is a permanent magnet with a bore in which the rotor can rotate. The rotor sits on an axle on which the commutator and the drive worms or gearwheels are also mounted, via which a torque is transmitted to the gearing.

Rotor and commutator are fixedly coupled by the axis. The rotor has three armatures, which are widened at the ends so that they overlap the stator as much as possible and the air gap is as small as possible. This results in a good magnetic flux. The armatures are wrapped with insulated wire, i.e. they form coils.



The function of the DC motor is explained in this chapter using the Märklin three-pole as an example, as it was also installed in this model of the 144 series (Art. No. 8825).

These are connected to the commutator, which changes the current flow direction in the coils. This results in a permanent rotation of the motor. The illustrative model with the poles that attract or repel each other is used as an explanation.

Figures 2* to 6* show cross-sections through the rotor and stator (left) and through the commutator (right and left), so that you can see how the armature coils are connected to the brushes.

In Figure 2* the brushes are not yet connected to voltage. In the armatures, the dipoles are aligned according to the magnetic field of the permanent magnet. A de-energised rotor will always align itself so that an armature points directly to the south pole or north pole as the upper armature in Fig. 1*.

Since the coils do not yet generate a field, the poles are displayed bright. The three armatures are each wrapped with insulated wire, both ends of which are connected to adjacent contacts of the commutator, thus forming a coil as shown in Fig. 2* for the upper armature. The winding direction is the same for all three coils. When a coil current flows, the poles are shown in dark.

If we apply a voltage to the brushes as shown in Figure 3*, a current will flow through all coils, one end of which is connected to the commutator with a voltage plus and the other to a voltage minus.

The coil around the upper armature is connected at both ends with plus, so no current flows. The current in the left armature generates a north pole (see hand symbol), the current in the right armature generates a south pole.

The left anchor is pulled up, the right anchor is pulled down. The current through the energized coils must be large enough to rotate the rotor so far that the brush of the positive pole no longer covers both upper commutator contacts. Then the coil of the upper armature is energized and the polarity is reversed.

The torque must not only rotate the commutator, but also overcome all forces that would furthermore act on the motor axis. In a locomotive, these are forces in the transmission, on the wheels and the force to accelerate the attached wagons. That's why locomotives start less smoothly if they are not well cleaned or if the train starts uphill.

In figure 4* the upper armature has turned so far that the upper brush no longer connects both commutator contacts. The current flows from the upper brush and the upper commutator contact into the upper left coil. From there it continues to the left commutator contact, which is also connected to the lower left coil and via this into the negative pole. The two left anchors form north poles and are pulled down.

In figure 5* no current flows in the lower armature, as the brush bridges the commutator contacts. The other two armatures must generate enough torque again to turn the rotor so far that the lower armature is energized and polarity gets reversed.

Figure 6* shows the polarity reversal of the lower anchor. The next picture would correspond again to picture 3* and thus the process repeats itself. If we reverse the voltage, the motor turns in the other direction.

Physically, the motor function is explained by the torque generated by the Lorentz force and ensures that in our example the left armatures always turn upwards and the right ones downwards.

***The numbers in this chapter refer to the illustrations on page 30.**

The detent torque

A de-energised motor is aligned in such a way that one of the three armatures points to a magnetic pole, in Fig. 2* of the previous chapter the upper one. This orientation is very stable. We feel this when we turn the motor by hand: This must be done quite vigorously until it moves out of the rest position.

This effect can also be seen during operation. The speed of the motor is controlled by the voltage applied, the torque by the current. This means that more current is required with increasing load at the same voltage.

The torque required for starting is called detent torque. Since a motor with a lower number of poles has a higher detent torque, it needs more current to start up. Once it is in motion, the inertia helps to keep it going. The motor now needs less energy - i.e. electricity - to continue running. This can also be clearly seen when we measure the current at start-up, for example on a three-pole Märklin locomotive of the 111 series with the article number 8842 (left picture):

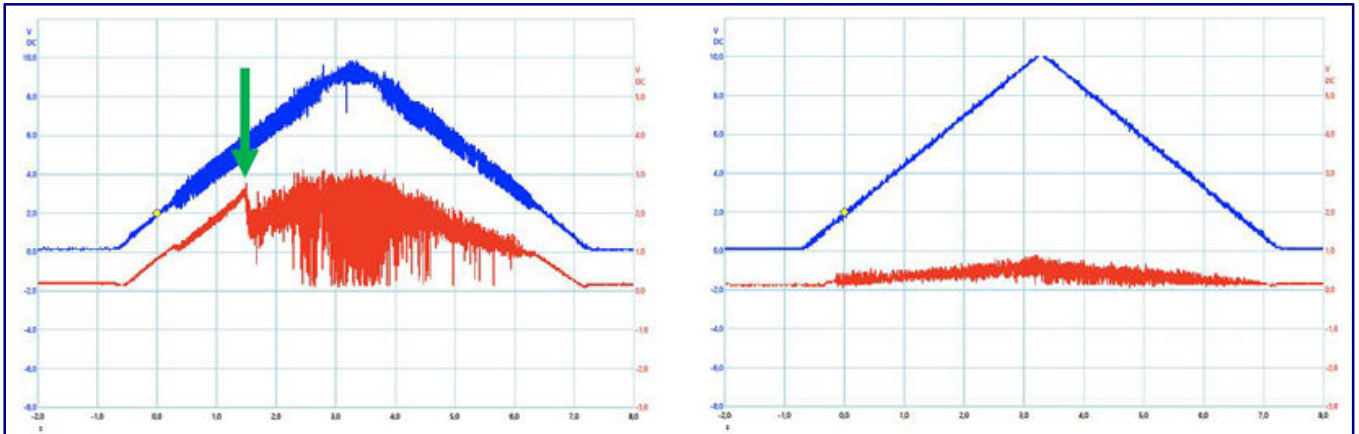

The current is shown in red, the voltage in blue. 1 V for current measurement corresponds to 0.2 A. Note that the zero line of the voltage is a grid above that of the current. We see how the current rises steeply with increasing voltage and then suddenly collapses despite further increasing voltage (green arrow in the picture).



The detent torque measurements were carried out using a Märklin 111 series model as an example, but in principle also apply to other models with the same drive type.

Exactly at this point the detent torque is overcome and the motor starts to rotate. After that the current rises again with the voltage, but now less steeply. The right picture shows the progression of a Rokuhan locomotive of the 181.2 series (Art. No. T950-4): Here you can see that their bell-type armature motor does not form a detent torque.

If there are many electrical resistances between the voltage source, usually a transformer, and the brushes, the motor gets less voltage and thus the current in the armature coils is also reduced.

The engine will then start worse and rotate slower. Causes for such electrical resistances are, for example, thin cable diameters, many connectors in the cabling, uncleaned rails, poor contacts due to soiling in the locomotive, worn brushes or even dirty commutators.

But what about the different motor concepts?

Märklin's iron armature motors

We now know how an iron armature motor works. But why did Märklin replace the original three-pole motors by a five-pole motors? This chapter is intended to illustrate this.



Märklin switched from three-pole to five-pole motors in 1999 with a model of the 143 series. Without any explicit announcement it worked in the Bordeaux-red model of the 143 361-4 (Art. No. 88431) and all subsequent variants (see picture).

A circle is divided into 360 degrees. With the five-pole motor, the armatures are offset by 72 degrees ($360^\circ/5$) instead of 120 degrees ($360^\circ/3$) with a three-pole motor, as are the commutator contacts. The brushes are correspondingly smaller because they can only cover a smaller part of the commutator circumference.

In order to rotate the motor from the stable position, a lower torque is required because less field lines flow through the armature without current, thus generating a smaller detent torque. To power it, we only have to turn it a smaller angle. The five-pole motor always has four energized anchors doing this work. So the more poles the better. But with more poles the motor gets bigger and more expensive at the same time.

Alternative with bell-type armature motors

The bell-type armature motor was developed by Fritz Faulhaber and is therefore also known as the Faulhaber motor. Faulhaber is today a well-known manufacturer of bell-type armature motors. Another well-known manufacturer is the Swiss company Maxon, which provides excellent information about motors on its website ("Knowledge about drives", see addresses in the info box at the end of the article).

In the bell-type armature motor, the permanent magnet is magnetised in such a way that the poles run longitudinally (Fig. 1). The permanent magnet has a hole in the middle for the drive axle and is firmly connected to the motor housing. The motor housing is magnetically conductive and guides the field lines back to the permanent magnet. Permanent magnet and motor housing form the stator.

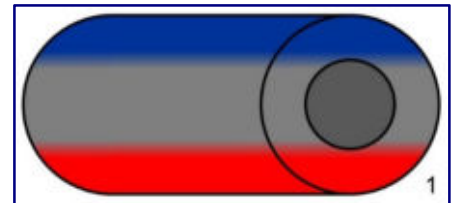

Between motor housing and permanent magnet are coils without core material. These are conductor windings, i.e. coils cast in synthetic resin. This is why we also speak of "ironless motors".

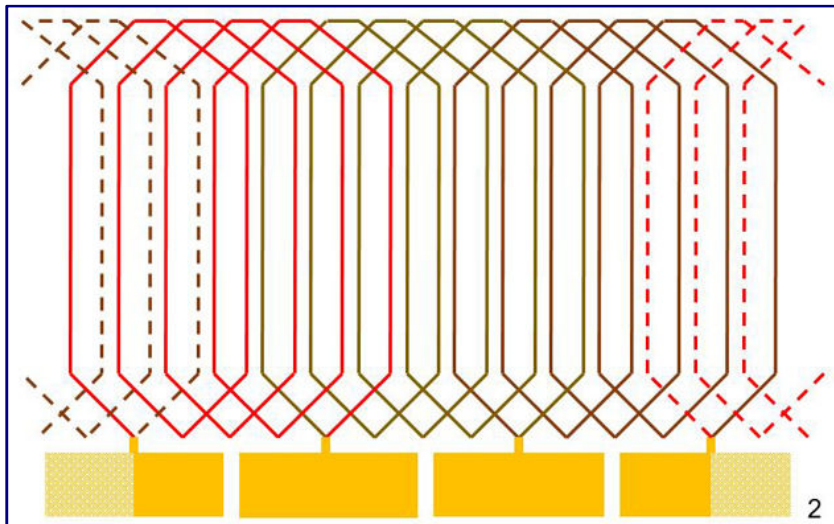

In picture 2 we see the coils "rolled out" for a motor with three armatures. The coils are connected to the commutator via contacts and the latter to the drive axis.

The assembly of drive shaft, commutator and encapsulated coils (armatures) thus forms the rotor and looks like a bell, hence the designation of bell-type armature motor (see Fig. 3).

Figure 4 shows a cross-section of the unpowered motor. For your understanding, the commutator is shown twice again.

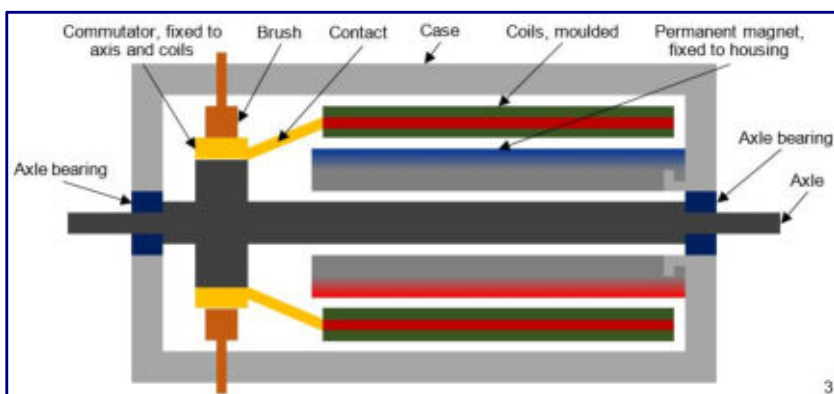

We see that there is no armature magnetization by the permanent magnet, since the armatures have no cores. Therefore, there is no detent torque.

If we energise the motor, a magnetic field is generated, but it has no fixed pole, so it is shown as a cloud (Fig. 5). In the example, the north poles would again form on the left and the south poles on the right, as in the example of the iron armature motors.

The explanation for the rotation is the same as for the iron armature motors, which is why no further pictures were created. Those who have read through the explanation of the Lorentz force will understand

the principle of the bell-type armature motor more easily. It is easy to imagine how the currents generate strong Lorentz forces through the long coil sections.

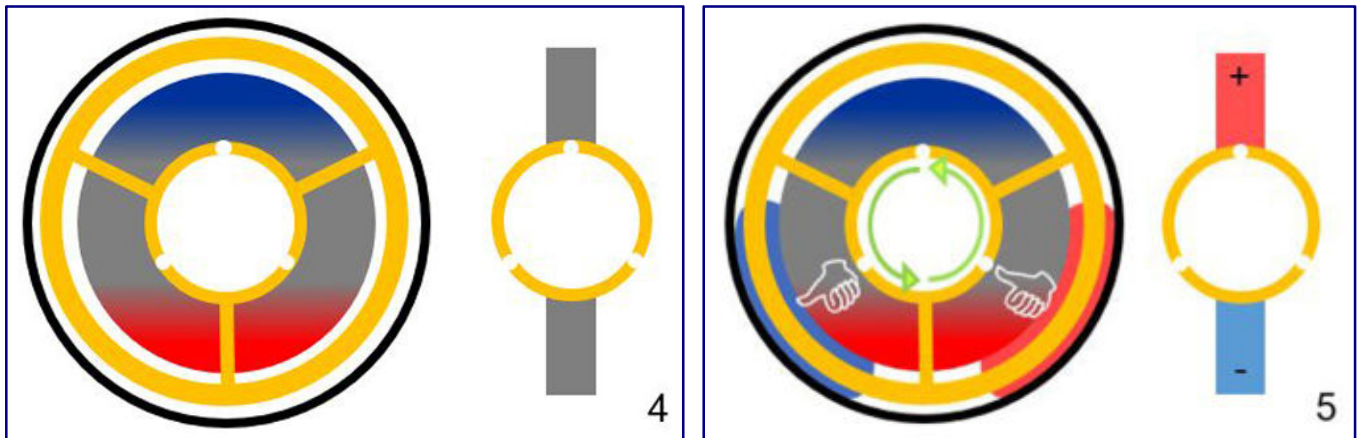

The phenomenon of brush fire

The current in a coil cannot "jump". This means that the current through the coil rises quickly but not abruptly to the maximum after the voltage is switched on and also decays when the coil is switched off. In the example, the voltage at the coil was switched on at 10 ms (milliseconds) and switched off again at 60 ms:

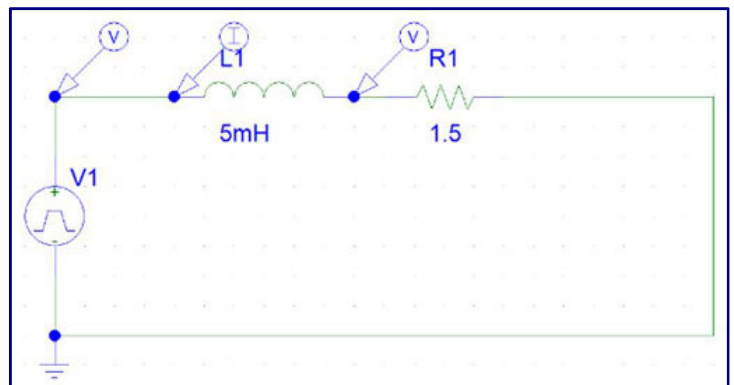
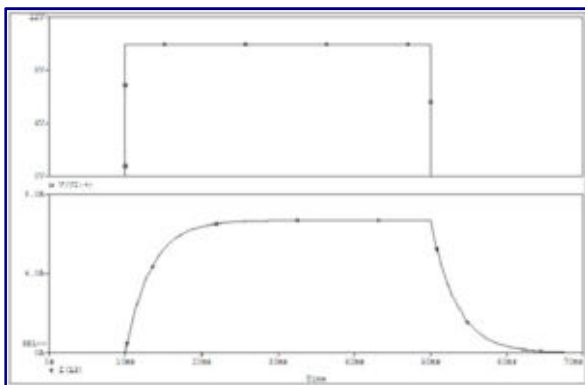

In a second simulation we switch the voltage on again and the current increases

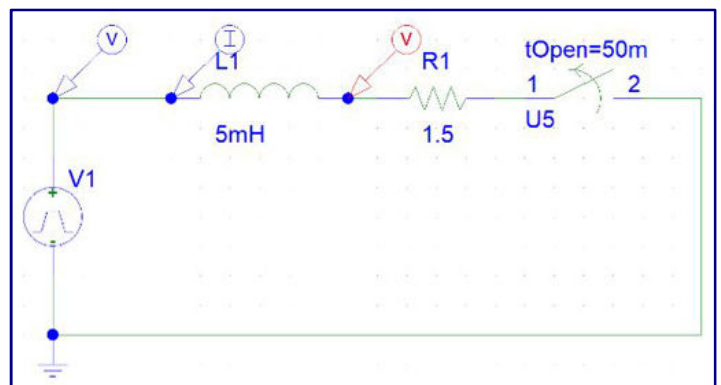
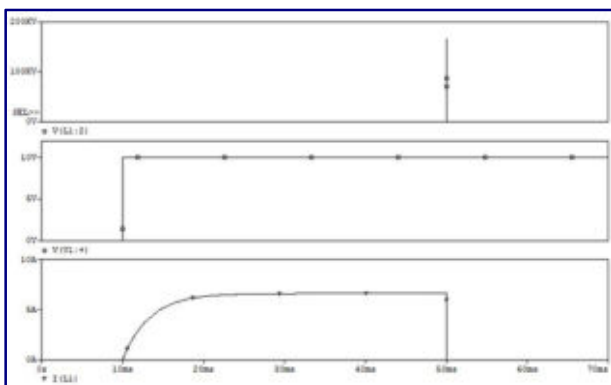

Then we separate the coil from the voltage source with a switch at 50 ms. This prevents the current from decaying and we see a sudden voltage increase, in the example, which is not comparable to a Märklin motor, up to a few kilovolts (kV).

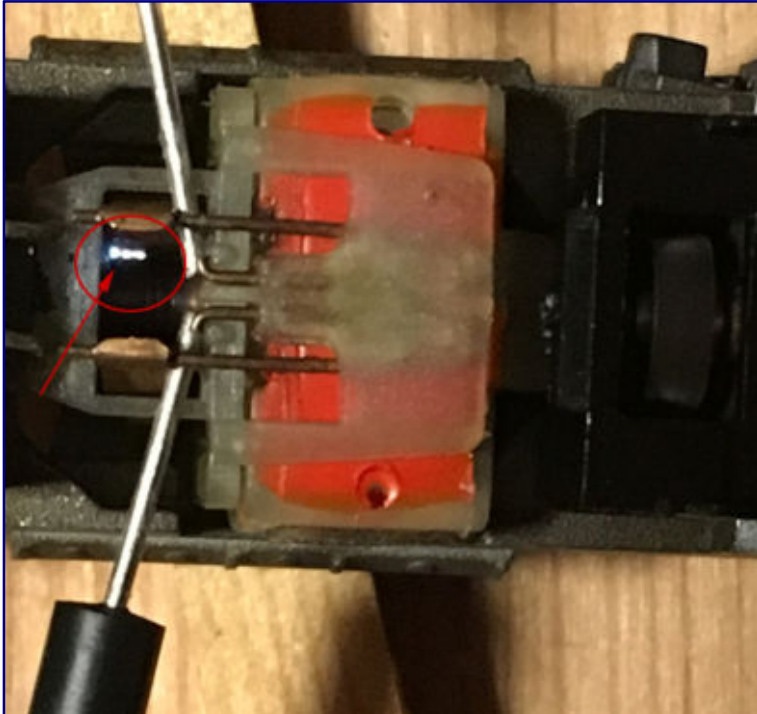

Brush sparks on a Märklin iron anchor motor

This separation of the coil from the brush is caused by wear or vibration. The high voltage discharges in the direction of the commutator as lightning, just like the voltage in a cloud when it flashes during a thunderstorm.

We can also sense this when we look at the brushes after a brush change. It gets very hot at the contact points of the flashes, which causes the brushes to burn off.

Brush firing can be minimized, however, if we operate the motor with the lowest possible voltages, ideally with a constant DC voltage, as this results in a minimal current.

If we use a digital voltage, i.e. a voltage that is constantly switched between maximum and minimum (see again article "High voltage or high tension?" in **Trainini®** 4/2018), we stress the brushes at maximum.

brushes can be avoided, as then the current in the brush cannot reach its maximum between switching on and off.

Old Märklin power supplies (transformers) are usually not particularly gentle on the brushes, as they do not emit a constant voltage, but a wavy voltage that moves around a medium voltage - as shown in the measurement.

As a result, the current is also wave-shaped and a current cut-off in current peaks leads to increased brush fire.

The new Märklin "Z Power Pack with 230 Volt Current Supply" is powered by an external power supply unit with an almost constant output voltage.

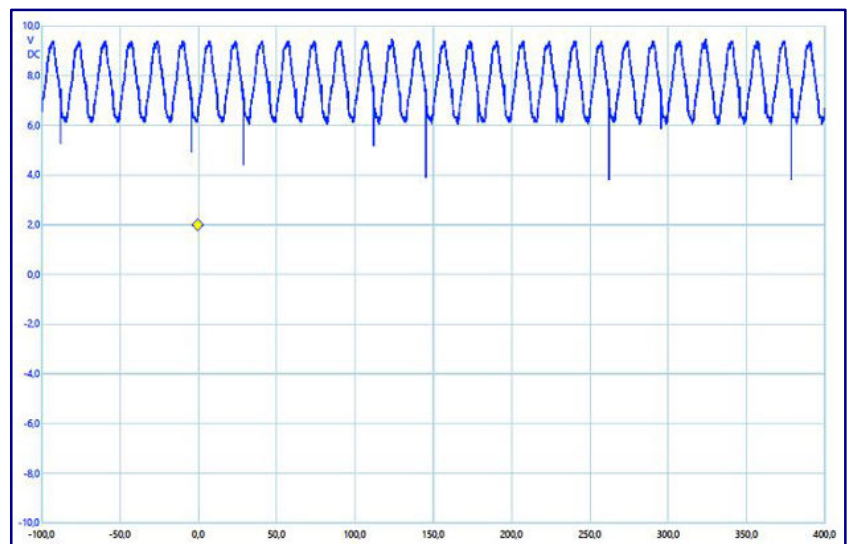

This means that the output voltage from the power supply is also almost constant and gentler on the brushes.

Comparison of motor concepts

Iron armature motors prove to be torque-strong and robust. They can be cleaned and maintained by replacing the brushes. Due to the armatures and the large stator, however, they are relatively large and heavy.

However, the armature weight also acts as a flywheel that keeps the motor running if there are short interruptions in the power supply. Iron armature motors need higher currents during starting to overcome the detent torque and during operation for reversal of polarity. That makes them quite loud.

Bell-type armature motors, on the other hand, have no iron cores. As a result, they have no detent torque, require lower operating currents and start smoothly and easily. They are small, light and quiet at the same time. Because of the smaller operating currents, they react with greater changes in speed to track contamination than iron armature motors.



Both iron-core and bell-type armature motors have advantages and disadvantages that have to be weighed up: Märklin has obviously done this for itself and is increasingly converting older designs to the new drive, in line with customer wishes.

They require no maintenance, but the motor must be replaced as soon as its brushes become worn. Since digital control promotes brush fire and thus also brush wear, they should only be operated at high switching frequencies without significantly shortening the motor life.

They are also sensitive to vibrations. We know that the plastic-coated armatures are only connected to the commutator and the drive shaft via the commutator contacts and that the gaps between the armature package, the permanent magnet and the housing are very small. Even a small shock can bring the anchor package out of its position and allow it to grind on the housing or on the permanent magnet.

Due to the very different motor characteristics, it is difficult to operate different motor concepts with the same control unit. If the control unit is designed for the small current range of the bell-type armature motor with small voltage steps in the low voltage range, the three-pole motor will not start at all, especially if two power cars are operated in the train, as in the Märklin model of the VT 11⁵ (Art. No. 8873).

A look into the future?

There is already a technical solution that solves the problems associated with the brushes. This is the brushless DC motor: Here the armatures are located in the stator and are connected directly to the voltage source via electronic switches - so-called transistors.

The transistors switch the voltage and direction of voltage on each armature individually.

Information about our author:

Alexander Hock studied electrical engineering at the University of Stuttgart and has been working for 25 years as a developer and project manager in the automotive supply industry.

He has been working in the USA since 2012 and lives in Commerce, Michigan. He would like to meet and exchange ideas with Z-gauge enthusiasts in his surroundings. You can contact our editorial staff for an email address.

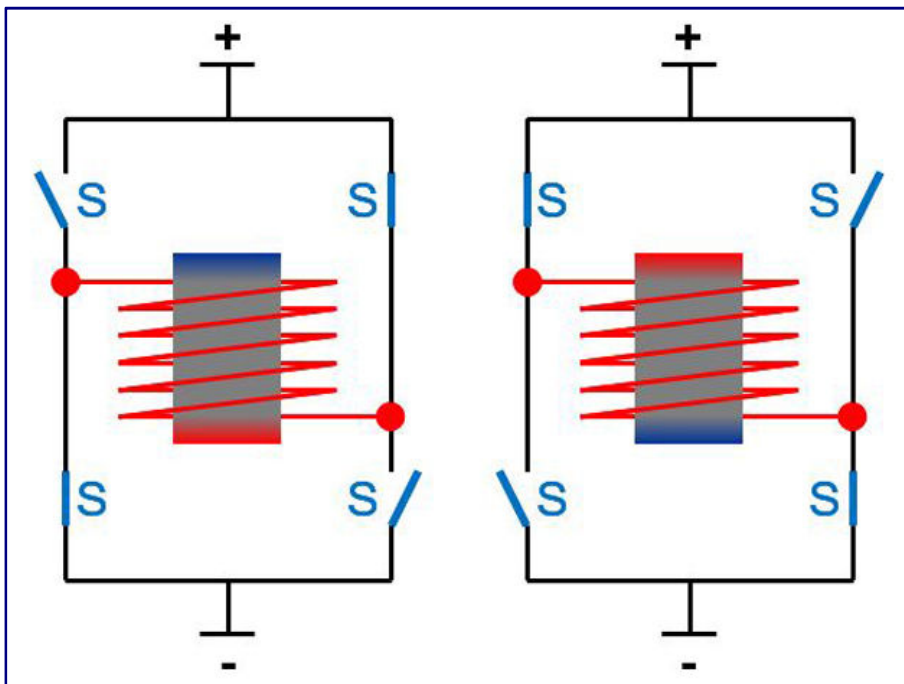

This allows the motor speed and direction of rotation for iron armature or belt-type armature motors to be controlled without wear.

The required switch positions are shown in the figure. If switches 2 and 3 are closed, the current flows through the solenoid in the opposite direction, as if switches 1 and 4 are closed.

This control requires separate cables per transistor and control electronics in the locomotive. Nevertheless, I think this will be the next big step for the Z-gauge motors.

All illustrations and photos (except pages 26, 31, 33 below, 34 and 38): Alexander Hock

Weblink tot he topic:

<https://www.maxonmotor.ch/maxon/view/content/maxon-Knowledge#>

Digital model railway control (part 3) The puzzle fits together

In view of the expenditures to be made, we would like to be clear in advance how extensive our own digital system should and must be. From this, it is also possible to determine which components and suppliers should be considered. This article is intended to help. We complete our overview today and also consider feedback options as a prerequisite for complete automation.

By Andreas Hagendorf. Only those who know the extent to which digital solutions (can) offer and determine at an early stage how far their own project should go can specifically select the required components and make the decision for specific manufacturers.

Ideally, good planning also results in an expandable system that is open for future expansion. Often the appetite comes with the food ...



The digital world is already ubiquitous and this does not only apply to model railways: Even with the model, nothing works without computers and data transmission.

In the last part we discussed the possible scope of digitally operated systems and explained various bus systems as data and partly also supply connections. We have also already turned our attention to the tasks of a control centre and the speed controller. But there are other elements waiting with boosters (amplifiers) and decoders that must not be forgotten.

Booster (amplifier)

The main task of the booster (from English "to boost") is to provide the track signal supplied by the central unit with electrical power for the consumers on the model railway.

The majority of the control panels on the market have an integrated booster that delivers more than sufficient power for most Z-gauge systems. It is very important to output the correct voltage: for track Z this is 12 V, the recommended maximum output current is between 2 and 3 A



Many of the central units available on the market already have an integrated amplifier (booster).

Many control panels depend on the connected power supply unit for the output voltage.

If this supplies 12 V supply voltage, a correspondingly low voltage is also present at the output. Even better are control panels where output voltage and current can be fixed.

If all this is not possible or if the central booster combination is known to be somewhat unreliable, then the use of Arnold Hübsch's DSR (Digital-Signal-Regulator) (AMW) is recommended to limit the digital voltage and to filter switch-on and other unwanted voltage pulses.

The device is connected between central station and track and can handle all digital protocols and RailCom.

A Märklin locomotive with the new bell armature motor consumes about 50 mA at maximum speed, the old 5-pin motor about 150 mA and the 3-pin motor up to 250 mA. Märklin engines from their Far East production phase can even reach almost 500 mA.

Depending on the quality of the LEDs used, the lighting is then switched on at 10 to 30 mA and a sound function at a further 50 mA. Assuming a well maintained sound locomotive that travels over the system at a realistic speed and thus has a load of perhaps 200 mA, eight trains can already be operated - with a safety margin.

The system is protected against a longer-lasting short circuit via the booster. This protection is triggered by exceeding a cut-off current corresponding to the maximum output current.

If a system is supplied with, for example, 6 A output current via a booster, the short-circuit fuse only reacts when this 6 A is exceeded. This current is sufficient to destroy the most sensitive parts of the locomotive triggering the short circuit, i.e. the wheels and the contact springs there. On a switch, the switch tongues probably also suffer significant damage.

Modern boosters have additional safety mechanisms. After a specified time they switch themselves on again automatically after a short-circuit shutdown. If the short-circuit is still present, they switch off again. The booster reports such short circuits to the central unit. This will then normally shut down the entire system.

If a definable overload warning current is exceeded below the cut-off current, the booster signals an overload warning to the central unit, but without switching itself off. A computer-controlled control panel could then switch off unnecessary functions such as sound or car lighting to avoid overloading.

Since the most current is consumed for a short time when a system is switched on than during operation, the booster suppresses the overload protection for a short period after switching on. In case of an overheating, the booster switches itself off automatically for self-protection.

A booster receives signals from the central unit at regular intervals. If it no longer receives these signals, it switches itself off because it assumes that the central unit has been switched off. Controlled boosters ensure that the track voltage remains constant regardless of the number of running trains and the other loads on the track. With unregulated boosters, however, this voltage can fluctuate.

A modern booster must also support RailCom. RailCom reports back values of a locomotive decoder via the rails. So that the locomotive decoder has time to send this data, a time interval is cut into the DCC signal (therefore also called “cut-out”) in which no signals are sent by the central unit.

If a very large system needs more power, it makes sense to divide it into several sections, each of which is supplied by its own booster. The parade route, the main station with its tracks, the staging yard or the depot can each be separate sections. It is important that the limits of the booster sections are crossed as little as possible.

The boosters of different manufacturers and sometimes also the various booster types of a single manufacturer do not always work well with each other. This can lead to problems and data transmission errors, especially at the track transition between two booster sections. The correct connection of the tracks must also be ensured.

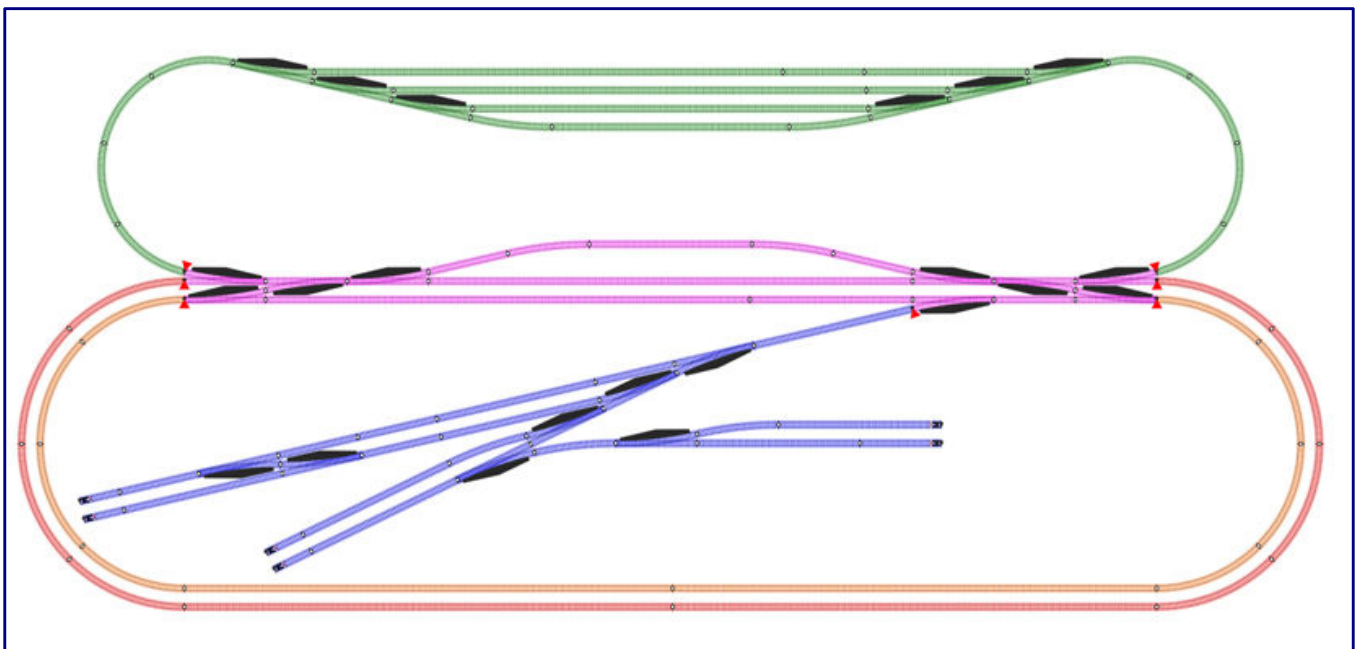

Schematic track plan, divided into booster sections as an example: Station (purple), staging yard (green), parade routes (red and orange) and goods station (blue). The separating points of the booster sections are marked with red triangles. Illustration: Andreas Hagendorf

However, different booster types can be easily combined, if one type is used only for locomotive functions and the other only for switching switches, signals and the like.

The same applies to the boosters integrated in the central units: Either use boosters from the same manufacturer or the integrated booster only for switching, and control locomotive operation with the same booster types from another manufacturer.

External boosters are connected to the central unit via the special booster bus PX, B-Bus, Loconet, Ecoslink or the CAN bus. Central control units and boosters from the same manufacturer help ensure full functionality and safety.

Track

Finally, the tracks transmit the digital signal to the vehicles and other users that may be present. In larger systems and when using many vehicles, the digital signal for switches, signals and other stationary consumers would better be routed via the ring line already mentioned in Part 1.

Thus we reward ourselves with much greater functional reliability. It is important that the interference suppression capacitors in the feeder tracks are removed. For a digital signal these are "interference capacitors." This of course also applies to all siding tracks that are not used as such but, for example, on covered lines like a normal track.

Decoder

The receiver of such an elaborately generated and transported digital signal is first and foremost a locomotive with a suitable decoder. It receives the travel and switching commands addressed to it and acts accordingly with speed changes or light or noise functions. The electrical power, which we hope will be sufficient, will be available for this purpose.

Using the example of a customized locomotive decoder Velmo LDS26306 for the Märklin model of the 111 series (Art. No. 88421) and technically identical sister models, we show here how a decoder works:

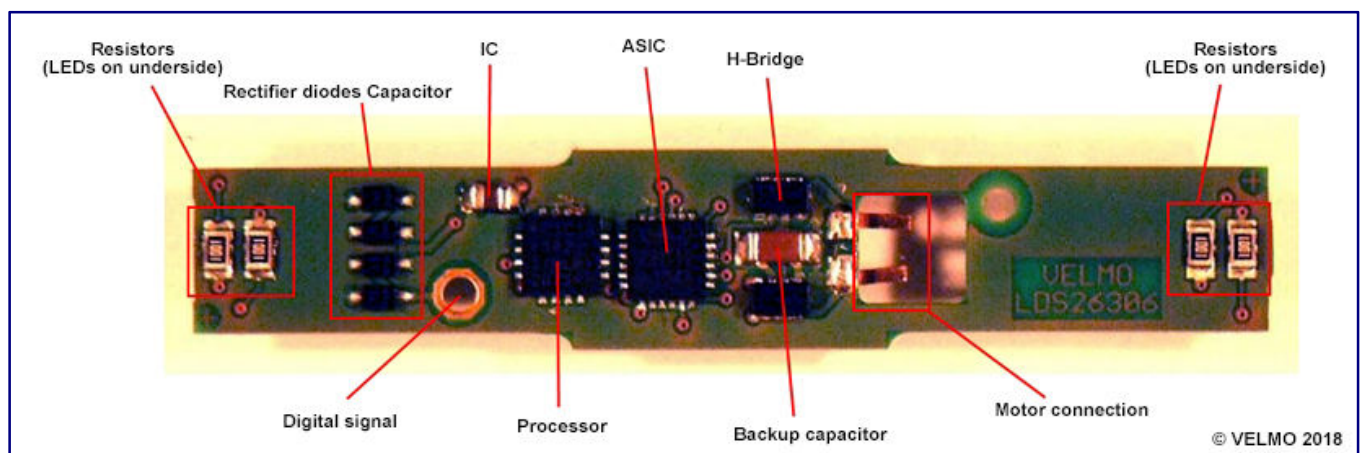
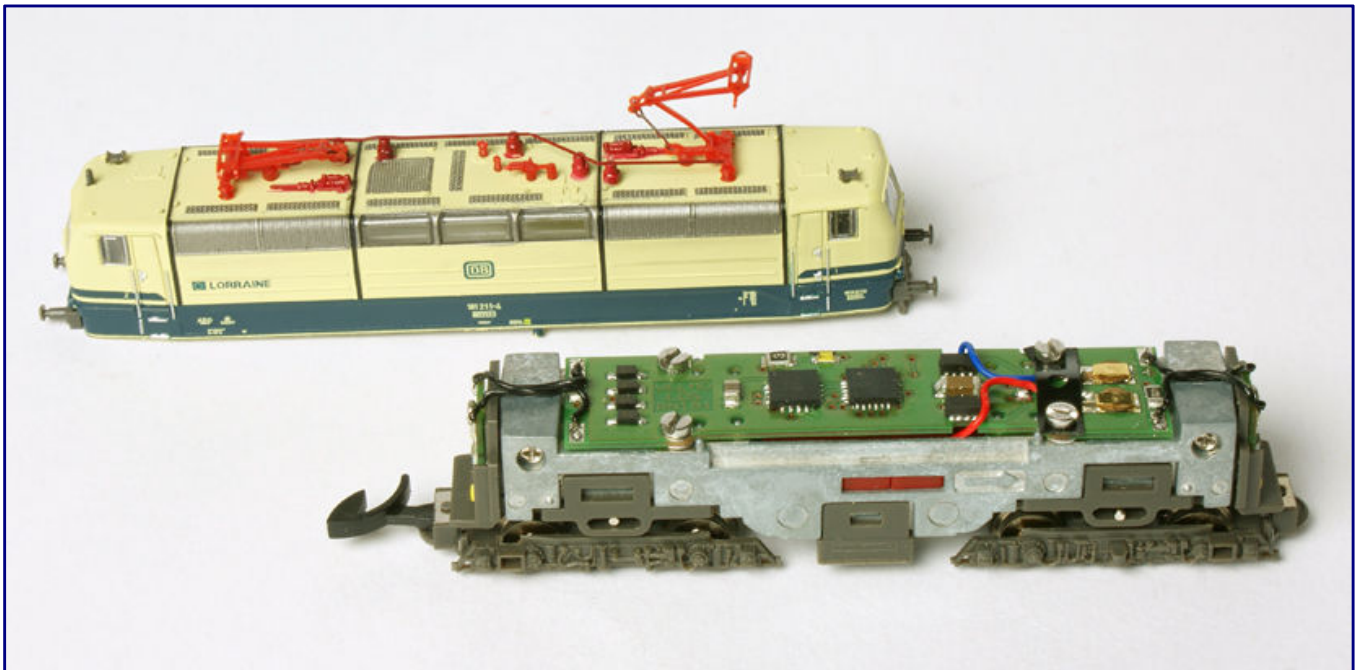

Illustration: Andreas Hagendorf

The digital signal applied to the track is routed to the wheels and the contact grinder to the screw holding the board, marked here with "digital signal." The rectifier diodes convert this AC voltage (see part 1 of our digital series in the April issue) into a DC voltage.

The unaltered digital signal supplies power to all active components on the board and also generates the PWM voltage for the motor. The unaltered digital signal is also sent to the processor, which has to filter the information on the speed level and light functions addressed to it. The back-up capacitor is required for a clean power supply for all ICs.

A special feature of decoders based on Doehler & Haass components (this is consistently the case with Velmo; editor's note) is the ASIC (Application Specific Integrated Circuit), i.e., an application-specific circuit.



Thanks to an ASIC (application specific circuit), the tiny Velmo boards still look tidy because they are based on components from Doehler & Haass.

It integrates many functions that are included on decoders from other manufacturers with extra components. Therefore, despite its tiny size, the board still looks very tidy.

The ASIC also controls the H-bridges, which rotate the motor in the direction required for the locomotive to move in the desired direction. The PWM (pulse width modulation) already mentioned above means that the motor is operated with a pulsed DC voltage of about 10 V, the width of the pulses corresponds to the speed step: the higher the speed step, the wider the voltage pulse (see diagram).

Even at the lowest speed steps, the engine receives, even if only briefly, the full track voltage and can reach its full torque. The buffer capacitor ensures that short interruptions of the digital signal, for example due to dirty tracks, do not cause the signal to jerk or even stop. It acts like an electronic flywheel.

The LEDs on the underside of the board are controlled via the respective series resistors according to the direction of travel and thus show the correct light image on the locomotive.

Besides the locomotive decoder there are further decoders:

- **Function Decoder**
These are basically locomotive decoders, only they lack the motor control. They control individual special functions such as wagon interior lighting or tail lights.
- **Sound Decoder**
They are also like locomotive decoders, but additionally receive components for the background noise of vehicles and a loudspeaker connection.
- **Switch Decoder (Magnetic article decoder)**
They control switches, form signals, un-couplers and comparable functional elements.
- **Feedback Decoder**
You convert sensor data into digital messages to the control centre or the computer.



In addition to the locomotive decoders, there are others that can also control turnouts or signals or provide feedback to the control centre.

We also differentiate between mobile decoders, i.e. installed in vehicles, and stationary decoders. The turnout or magnetic decoders are typical stationary decoders, because they are installed in or under the turnout, the decoupling track or the signal.

Sound decoders play stored sound files via the connected loudspeaker. They can be installed in vehicles and reproduce their model operating noises or be installed in static models or scenes.

Newer sound decoders have several channels through which several sounds can be played simultaneously, for example the piston beat of a steam locomotive to its rolling noise on the rails. Many sound decoders also allow you to import your own files via a computer program.

Turnout decoders are used to switch turnouts and other magnetic articles such as form signals and uncouplers via a central control unit. To switch a turnout with a turnout decoder, the turnout also needs a turnout drive. The turnout decoder used must be suitable for its respective drive.

Märklin turnouts, for example, have a double coil drive, i.e. two electromagnetic coils, one for each switching direction, which are controlled via separate connections. Rokuhan switches have only one coil, which is switched by reversing the polarity of the voltage.



The multi-central unit from Roco (right), which is also used in Z gauge, is both a handset control and a small central unit. It can also switch points or mechanical signals. Its modern successor is the WLAN mouse (left) from the same manufacturer.

The actual switching process for both coil drives is carried out by a short voltage pulse. The length of this pulse should be adjustable in the weighing decoder, so that the switching process is carried out safely and completely on one side and on the other side the pulse is not too long and allows the coils to burn out.

If the turnouts are retrofitted with servos, the used turnout decoder must also be able to control this type of turnout.

Turnout decoders can also be used to control other magnetic articles, such as decoupling tracks or mechanical signals. It is always useful to activate

braking and stopping sections of signals, for example, by means of additional switching connections.

Special decoders are used for digitally controlled light signals, which can then supply both the main signal and the respective distant signal with the appropriate signal images. Here, too, there should be the possibility of switching the braking and stopping sections. Transfer tables or turntables for service areas also require specialized decoders.

Feedback decoders (actually feedback encoders) record the information from connected sensors, convert it into a digital signal (encoding; encrypting) and send it to the control centre. The connected sensors (feedback) can be track occupancy detectors, light barriers or switch status detectors via micro switches. Feedback decoders are connected to the central unit via one of the various bus systems.

The track occupancy detection is very important for the function of track pattern signal boxes, especially for staging yards and is absolutely necessary for semi-automatic or fully automatic operation with a computer control system. The technical implementation can take place in different ways.

When the current sensor is moved, a track section is isolated on one side and provided with a circuit that establishes the current connection and can additionally detect whether a power consumer, i.e., a motor, car lighting, a decoder or other resistance is on the monitored line.

So-called reed contacts can be used to monitor individual points on a track section. A reed contact is a small switch housed in a glass tube.

If a vehicle drives over the contact with a small permanent magnet mounted under the car, the very sensitive switch is short-circuited and triggers a contact process in the busy indicator.

In order to monitor an entire section, the inserted circuit must be able to remember this impulse. A second reed contact then sends a signal again when the car leaves the section.

Reed contacts are very cost-effective and can be installed almost invisibly in the track bed. The permanent magnet on the vehicle can be very difficult or even impossible to accommodate, or it interferes when travelling over switches or uncouplers.

Alternatively, light barriers can be used to avoid the problem of vehicles without the space availability for a permanent magnet. Since they are relatively large, however, their placement on the track can be problematic. They can be located in a tunnel or in a railway operating building so that they do not attract attention.

RailCom

All of the above procedures have the disadvantage that although it is noticed when a track section is occupied, it is not possible for the system to recognize what is written there. One solution here is the feedback system RailCom (notation: RailCom). This is an extension of the DCC standard, among other things for vehicle identification.

It can be used to read out the data of a locomotive decoder, especially its address. A local “detector” is used for this purpose. This, together with a track occupancy detector, indicates which vehicle is in the occupied section.

The global RailCom detector in a control centre can detect any new locomotive. However, the prerequisite is that all components involved are able to use RailCom: Central unit and booster, decoder and feedback.

It is particularly interesting for staging yards. Not only a train, but also its number can then be seen on a signal tower. The fully automatic computer control system can then send this train at a specified time along a special itinerary previously defined only for it.



Märklin offers everything from a single source: Mobile Station 2 can also be used as a small control centre for Z scale. If the plug-in power supply unit supplying them is replaced by that of the new traction control unit, the track voltage automatically matches.

Summary

As already stated at the beginning, there is not a single digital control for every need. Of course, recommendations from friends and acquaintances provide important clues. But perhaps the time will come when equipment procured exclusively on such advice can no longer fulfil one's own wishes.

The central point should therefore always be to determine and record one's own wishes and requirements as precisely as possible.

Once this list has been completed, it will be easier to match the requirements with the extensive range of small and large manufacturers.

Unfortunately, many systems and components are too expensive to be purchased early and only tried out.

Contacts with groups with digital members, where one or another product can easily be tried out on site or borrowed is encouraged.

Many model railroaders have already used computer controls and are happy to share their experience. Another contact point is specialist dealers who offer their digitalisation services to a freely selectable extent for a fee. The money invested there will certainly make up for any misspending saved.

In the next issue we will digitize a small, simple system step by step based on what we have learned so far. This system will be used again and again later for further contributions on the subject of "Digital in Z gauge."



Whatever your decision may be: Before you make it, every model railroader should be aware of his wishes and requirements and take advantage of testing opportunities when they arise.

Internet addresses of component manufacturers:

- <https://amw.huebsch.at>
- <https://doehler-haass.de>
- <https://www.maerklin.de>
- <https://www.roco.cc>
- <https://www.velmo.de>

Information about RailCom:

- <https://www.lenz-elektronik.de/digitalplus-railcom.php>

Jetzt schon vormerken!
Aktuelle Programinfos: www.maerklin.de



Tag der offenen Tür

am 14. und 15. September 2018
von 9.00 bis 16.00 Uhr
Einlass ins Werk

Aktuelle Programinfos:
www.maerklin.de



Kommen, sehen, staunen:

Märklin öffnet in Göppingen die Türen zur gläsernen Produktion. Für alle, die schon immer hinter die Kulissen schauen wollten. Erleben Sie Werksführungen durch die Fertigung, die Entstehung und den Baufortschritt des neuen Märklineum und Sonderpräsentationen. Für die ganze Familie ist etwas geboten – **Wir freuen uns auf Ihren Besuch!**

Vorankündigung!

14. und 15. September 2018 in Göppingen



Besuchen Sie das Märklineum mit seinem fertiggestellten ersten Bauabschnitt, den neuen Märklin-Store und erleben Sie die BR 44 1315 als imposantes Wahrzeichen in ihrem neuen Heimatbahnhof!

Jetzt besuchen!



Note for English readers: The literature section that follows is not translated into English because the original text of the books involved are in the German language. The original German is left here for information purposes only.

Ratgeber für Spritzlackierungen aller Art **Vom richtigen Umgang mit Farben**

Was nützt ein perfekter Modellbau, wenn es an den Fähigkeiten und Werkzeugen für die sich anschließende Farbgestaltung mangelt? Wird ein Modell an dieser Stelle ruiniert, ist der Ärger groß und womöglich verbindet sich das auch noch mit beträchtlichem finanziellen Schaden. Mit Mathias Faber widmet sich ein Profi mit enormen Fähigkeiten und gutem Auge diesem Feld und macht aus wohl jedem Modellbahner einen Köhner auf dem Gebiet der Spritzlackierungen.

Mathias Faber
Airbrush im Modellbau
Farbe auf Stand- und Funktionsmodellen

GeraMond Verlag GmbH
München 2017

Klappenbroschüre mit Fadenheftung
Format 16,5 x 23,5 cm
160 Seiten mit ca. 180 überwiegend farbigen Abbildungen

ISBN 978-3-86245-533-1
Preis 20,00 EUR (Deutschland)

Erhältlich direkt ab Verlag
oder im Fach- und Buchhandel

Bereits bei unserer ersten Besprechung eines Titels von Mathias Faber haben wir uns begeistert von seiner anschaulichen Weise des Erklärens anspruchsvoller Arbeitsgänge und -techniken gezeigt. Diese Fähigkeiten sind selten und eine wesentliche Stärke auch dieses Bandes, den wir heute vorstellen möchten.

Nachdem das zuletzt vorgestellte Werk das Arbeitswerkzeug Spritzapparat, den richtigen Umgang mit ihm sowie Warten und Pflegen dieses Hilfsmittel zum Thema hatte, widmet der Autor sich nun dessen Einsatzmöglichkeiten in der Praxis.

Immerhin spielt der Farbauftrag mit Druckluft auch im Modellbau inzwischen eine zentrale Rolle. Mit keinem anderen Werkzeug ist es möglich, derart gleichmäßig und dünn, gleichzeitig aber auch deckend, Farben und Lacke aufzutragen. Doch es kostet Geld und persönliches Überwinden, sich dieser Technik zuzuwenden, sie zu erlernen und sich ihrer dann gezielt zu bedienen.

Auch an dieser Stelle leistet Mathias Faber wieder gezielt Hilfe und nimmt seine Leser mit auf eine Reise in eine spannende Welt voller Möglichkeiten. Der Lesefluss ist gut, die Schreibweise unterhaltsam wie auch fesselnd. Selbst komplexe Themen werden so gekonnt aufbereitet, dass ihnen leicht zu folgen ist. Kaum ein Ratgeber vermag das in einer solchen Form zu leisten, dass es kaum persönlicher Hilfestellungen durch einen Lehrer bedarf.

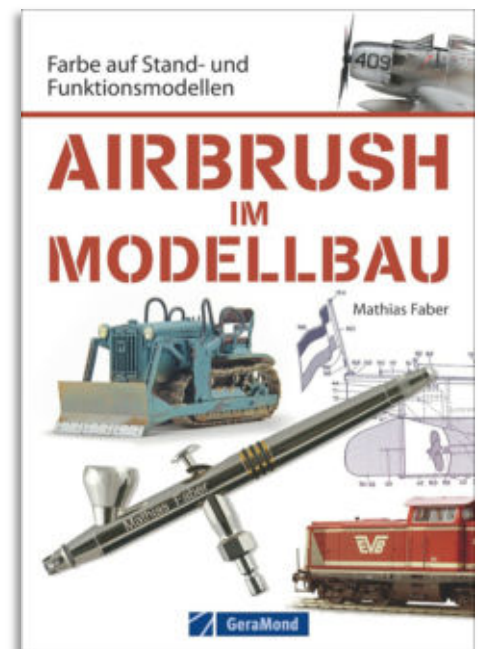

Was geht überhaupt alles mit einer Spritzlackierung, wie geht das, wo wird es spannend und wo heißt es besonders vorsichtig zu sein? Dies sind die zentralen Fragen, die sich jedem Anfänger und auch Fortgeschrittenen stellen und hier einen roten Faden bilden.

Um all das gezielt und gekonnt zu behandeln, bedarf es etwas Wiederholung am Anfang des Buches: Hier wird die Arbeitsweise des Werkzeugs vorgestellt und die Quelle der Druckluft aus praktischen Gesichtspunkten heraus betrachtet. Auch der Luftradierer („Air Eraser“) als Sonderform des Werkzeugs findet dort Erwähnung.

Bevor es in die Praxis am Modell geht, stellt der Autor Übungen vor, die dem richtigen Erlernen des Anlegens eines Spritzgrunds dienen sowie dem Aufbringen von Linien, Punkten, Flächen und Verläufen dienen. Das ist wichtiges Elementarwissen, um schnell erfolgreich zu sein.

Etwas anspruchsvoller wird es schon, wenn die Aufgaben von Maskierungen dargelegt werden. An dieser Stelle geht es neben den richtigen Techniken auch um geeignetes Material, das sich sonst erst mit vielen Versuchen finden ließe.

Nicht zu unterschätzen ist ein Ausflug in die Welt der angebotenen Farben: Sie haben vielfältige Funktionen und werden in verschiedensten Qualitäten angeboten. Sich in den Angeboten der vielen Hersteller zurechtzufinden und daraus geeignete Einzelprodukte für die jeweilige Aufgabe zu finden oder unterschiedliche Komponenten so zu kombinieren, dass sie zueinander auch verträglich sind, zeigt Mathias Faber ebenso auf.

Hier stellt er auch die Bedeutung von Testmaterial heraus, auf dem aussagekräftige Versuche ohne das Risiko des Zahlens von Lehrgeld erfolgen sollten. So gerüstet geht es dann an die Praxis mit „echten“ Modellen, die aus den unterschiedlichsten Modellbausparten stammen. Sie berücksichtigen die vielfältigsten Anforderungen und können gleichzeitig sogar spartenübergreifend Kniffe und Techniken mitgeben.

Diese Neuauflage eines beliebten Standardwerks aus dem Jahr 2015 bietet in dieser Weise viele detaillierte Anleitungen, hilft bei der Auswahl der passenden Geräte und führt durch ein großes Anwendungsspektrum. Die abwechslungsreichen Beispiele beflügeln zugleich die Kreativität ihrer Leser.

Ausgestattet mit hilfreichen, aussagekräftigen wie auch handwerklich guten Abbildungen und Fotos hervorragender Wiedergabequalität möchten wir auch dieses Buch jedem empfehlen, der sich der anspruchsvollen Farbgebung von Modellen und Landschaft zuwenden möchte. Dabei spielt es keine Rolle, ob der zuvor besprochene Band schon im heimischen Regal steht oder nicht.

Publisher pages with reference possibility:
<https://verlagshaus24.de/geramond>

Mit Leichtigkeit zum hohen Anspruch Immer nur dreckige Phantasien?

Eine jahrelange Geschichte weist die Reihe „Miba-Modellbahn-Praxis“ auf. Sie widmet sich den verschiedensten Themen der Anlagen- und Modellgestaltung, darunter waren auch schon Ausflüge in die Welt der Farben und Lackierungstechniken. Pit Karges greift in einem der jüngeren Bände zu Pinsel und Spritzgriffel, um Lok- und Waggonmodellen den letzten Schliff zu geben.

Pit Karges
Fahrzeug-Finish mit Pinsel und Pistole
Loks und Wagen altern – realistisch nach Vorbild
Miba-Modellbahn-Praxis 1/2017

Verlagsgruppe Bahn GmbH
Fürstenfeldbruck 2017

Geklammertes Heft
Format 21 x 29,7 cm
84 Seiten mit über 240 meist farbigen Abbildungen

ISBN 978-3-89610-654-4
Best.-Nr. 150 87452
Preis 10,00 EUR (Deutschland)
auch als elektronische Ausgabe erhältlich

Erhältlich direkt ab Verlag
oder im Fach- und Buchhandel

Autor Pit Karges kam schon 1972 im zarten Alter von sechs Jahren mit der Modellbahn in Kontakt. Zu einem seiner Steckenpferde entwickelte sich neben einem überzeugenden Landschaftsbau auch das vorbildgerechte Altern der auf einer Anlage verkehrenden Züge. In seiner Einleitung des heute behandelten Magazins bezeichnet sich der Polizist daher selbst als „Saubermann mit dreckiger Fantasie“.

Mit diesem Credo rennt er bei unserer Redaktion offene Türen ein, denn auch wir bezeichnen uns als Verfechter realistisch aussehender Modelle. Die Entwicklungen der letzten Jahre und viele Fotobeweise geben uns recht. Ebenso unterstützen wir den Ansatz „Vom Vorbild zum Modell“, das bedeutet ein vorheriges, systematisches Studium der Vorlagen auch im historischen Kontext, bevor es ans Umsetzen geht.

Schwierig wird es für viele Leser dann, wenn es um die richtigen Techniken geht und auch handwerkliche Kniffe hilfreich sind. Genau da setzt die Miba-Reihe immer wieder an und versucht, Schritt für Schritt aus einem gewöhnlichen Modellbahner einen selbstsicheren Kunsthandwerker zu machen, der vor keiner Herausforderung zurückschreckt. Ein jeder wächst doch mit seinen Aufgaben!

Der Autor möchte deshalb zeigen, wie von leichtem Bremsstaub im Fahrwerk bis hin zur total verdreckten Lok eine große Bandbreite an Betriebs- und Witterungsspuren umgesetzt werden kann. Schritt-für-Schritt-Anleitungen sollen den Leser anhand der unterschiedlichen Fahrzeuge leicht verständlich durch ein gar nicht so schwieriges Feld führen. So lautet der selbstformulierte Anspruch des Verlags in eigenen Darstellungen.

Und so befassen sich die einleitenden Grundlagenkapitel auch mit Arbeitsgeräten, Farben und Lackiertechniken im Allgemeinen. Den praktischen Übungen mit speziellen Aspekten inklusive vorbildgerechten Verbeulens von Güterwagen, dem einfachen Fertigen von Lackiermasken (teilweise mit



„Post-it“ von 3M) oder dem sogenannten „Chipping“ und „Washing“ (lasierendes Patinieren) sind die Folgebeiträge gewidmet.

Bis hierher klingt das Geschriebene noch durchweg tadellos, zumal auch die Bildauswahl gelungen erscheint. Ebenso ist die Wiedergabe der Modell- und Vorbildaufnahmen durchweg auf dem erwarteten, hohen Niveau.

Doch ohne Schwächen bleibt diese Ausgabe dann doch leider nicht. Am gravierendsten erscheinen uns Fehler bei den Angaben der gebräuchlichsten Eisenbahnfarben für die deutschen Bahnverwaltungen ab 1945: Da schreibt der Autor das ab 1988 übliche RAL 3031 Orientrot den Diesellokomotiven bereits ab 1956 zu oder bezeichnet RAL 6009 Tannengrün als typische Farbe von Reisezugwagen bis etwa 1976.

Das führt bei uns ebenso zu Kopfschütteln wie die Angabe von RAL 5013 Kobaltblau für die schnellfahrende Elektrotraktion, denn auch die war die längste Zeit mit RAL 5011 Stahlblau in einem anderen Farbton unterwegs. Auch als Filterfarbe erscheinen uns die nicht korrekt angegebenen Töne nicht geeignet.

Zusammen mit falsch benutzten Fachbegriffen wie etwa der „Pistole“ (statt Spritzapparat oder -griffel), die eher den Schichtdienst als das Hobby des Polizisten begleiten sollte, stellt der Autor seine – für uns übrigens unbestrittene – Kompetenz an gleich mehreren Stellen leichtfertig in Frage.

Der Leser kann hier leider den Eindruck gewinnen, der Verlag habe in dieser schon viel Jahre geführten Reihe inzwischen sein Pulver verschossen und greife nun auch auf zweitrangige Schreiber zurück.

Doch genau das ist nicht der Fall, wie wir ausdrücklich bestätigen möchten. Zwar sind nicht alle Arbeitsschritte wegen zu vieler und damit zu dicker Farbaufträge auch für die kleine Spur Z anwendbar, doch hilfreiches Grundwissen wird hier sehr wohl vermittelt. Auf den kleinen Maßstab sind einige Techniken eher in Teilen übertragbar, damit sie auch dort ihre Wirkung entfalten.

Ein Haken der Artikel ist zugleich auch eine Stärke mit Blick auf Anfänger: Nur wenige Techniken kommen bei den Arbeiten des Autors zum Einsatz und wiederholen sich in jedem Artikel als Basis aller Alterungen. Was erfahrene Patinierer schnell langweilen kann, bedeutet für Anfänger sicher eine grundlegende Erkenntnis und schnellen Überblick.

Gut gefallen hat uns hier der ebenso beständig wiederkehrende Arbeitsschritt des Filterns. Dahinter verbirgt sich der nicht deckende Überzug mit der Grundfarbe des Modells, um zu harte Kontraste zu mildern. Darauf werden sicher alle Neulinge bisweilen zurückgreifen müssen, bis sie die Wirkung ihrer Farben richtig einzuschätzen zu wissen und die beste Dosierung gezielt zu steuern wissen.

Publisher pages with reference possibility:
<https://shop.vgbahn.info>

Readers' letters and messages

Zetties and Trainini in Dialogue

Thank you for each letter to the editor and all the feedback that reaches us. Write us (contact details see imprint) - Trainini® lives from dialogue with you! Of course, this also applies to all suppliers in Z gauge, who would like to introduce innovations here. A representative image is our goal. Likewise, here we note any events or meetings with a significance to Z gauge reference, if we are informed in time.

Something personal to the layout portrait of this issue:

Here is Christoph Maier, the builder of Winzlingen, the small Z-gauge system, which I presented a few days ago in the ZFI-Forum. I would like to follow Holger's invitation and get in touch with you.



An excerpt of the "Winzlingen" with 89th class. Photo: Christoph Maier

In a nutshell: I think that everyone who presents their project in a forum is hoping for some praise, recognition and constructive feedback. However, I really didn't expect such a positive response.

On the one hand I am very happy with it, but on the other hand I am slightly embarrassed by so much prominent attention. I have been reading regularly in silence for over two years and there are some very nice current projects in the Forum (ZFI; editor's note) and certainly also in the background.

Apart from that I don't know the Z scene at all and it would make me a little uncomfortable if more established Zetties could feel embarrassed, because a newcomer, who has not contributed anything to the community so far, gets a layout portrait in **Trainini®**.(...)

And once again a big thank you for bringing out a **Trainini®** edition worth reading every month. The regular reading of the issues has really helped me enormously to find my way into my hobby and taught me a lot about materials, techniques, sources of supply and the great role models. That you do this on a voluntary basis and at such a consistently high level of quality, kudos!

Christoph Maier, by e-mail

An obituary for Michaela Holst:

In the late evening of 10 July 2018, Michaela Holst of the club "team Z hamburg" (club's own spelling) died at the age of 47. For many years Michaela had decisively co-organized and accompanied the trade fair and exhibition participations of this and a predecessor group, among other things, by taking over the catering for the persons involved.

As a founding member of Z-Freunde International e.V., she became known beyond this group in 2011, where she was elected as the first exhibition commissioner at the founding meeting and also had a decisive influence on the first trade fair participations.

But suddenly and unexpectedly Thomas Zander and her regulars had to say goodbye: The news of her death arrived during the monthly meeting of the Hanseatic association. Team Z Hamburg and the editorial staff of **Trainini®**, who knew of her and the club, will honour Michaela. May God have mercy on her soul.

A beetle supplement and a little novelty:

The articles on the history of the VW Beetle in the last issue were well received by the majority of our readers. Although it is an off-rail topic, the most built automobile in the world seems popular enough to systematically deal with the model history of an accessory.



This was the light blue beetle from Limized (left photo), to which we had referred in the last issue. The latest Beetle model is the one from Trafofuchs, which we would like to show here again in its successful design as the film car "Herbie."



At this point we would like to hand in a reader photo showing the light blue beetle from the production of Limized.

On the page of the June issue we had already noted in a caption that the specimen shown must be the dark blue version. The colour tone left open interpretations because it is a medium blue.

Thanks to the letter from Dr. Sven Rohmann, our impression has now been clearly confirmed.

Left picture:
New at Trafofuchs is this camping bus, whose design is based on the VW T6. Photo: Trafofuchs

At this point we would also like to show a photograph of the latest model from Trafofuchs, which is perfectly suited for a Herbie design because of its base colour beige.

But Birgit and Volker Brock also have other ideas in their luggage. Inspired by the VW T6 van, they have created a freely designed camping bus. Based on similar models and caravans for past epochs, it now serves the present on the model railways. It can be combined with the camping sets, tents and campers from our own programme.

Trainini Raffle 2018 - find the mistake!

We think it is always worth reading our magazine carefully. And so we combine this issue with a small **Trainini Raffle 2018**.

Among the first ten e-mail senders with the right solution, we will draw a book prize and announce the winner in the next issue briefly with name and place of residence. Your personal data will only be collected for the purpose described and for sending the prize.

Helpers listed in the imprint of this magazine and their relatives are not allowed to participate. Legal recourse is excluded.

Only if you agree to these conditions and would like to allow us to consent to the disclosure of your name and location (please do not forget your name and address), then answer the following question:



In which image of this issue is an error hidden and how does it appear?

Please tell us the page and briefly describe the type of error found in your message to [gewinnspiel\[at\]trainini.de](mailto:gewinnspiel[at]trainini.de). For assignment, enter **Trainini Raffle 2018** as the subject of the message **Trainini Gewinnspiel 2018**.

The deadline for entries is Wednesday, 15 August 2018, and in August we will provide the answer with explanations and further photographs, and disclose the winners.

What's new at Noch:

Some design products from the new products 2018 have now been delivered by Wangen-based accessories supplier. The following should be listed here:

For water design

Model water XL, 500 ml (Art. No. 60874)

Waves & Swells, 150 ml (60861)

Foam & Spray, 30 ml (60862)

For road design

Road construction structure paint, asphalt grey, 250 ml (60825)

Road construction structure paint, asphalt anthracite, 250 ml (60826)

Road construction paint roller, 50 mm wide, with spare roller (60829)

These aids are available in all good model railway shops or via the manufacturer's electronic sales department (<https://www.noch.de>).

Special beer car models at the 1zu220-Shop:

We had already reported that as part of a move of the 1zu220 shop to business premises on the grounds of the Westheimer brewery, a Märklin special car would be installed. It was available for the first time at the Z-Treffen in Altenbeken.



The Westheimer beer wagon from the 1zu220 shop has now been joined by its first colleague. Matching the colours of the beer brand "Graf Stolberg Dunkel" is a black lacquered version.

This is a covered freight car of type G 10 without brakeman's cab in pure white paint (RAL 9010). It bears the inscription "Westheimer Premium Pilsener" and the picture of a filled beer glass with bottle (Art. No. 98160). The roof colour is RAL 9007 grey aluminium.

The wagon was printed in a unique edition of 100 copies by Märklin and additionally provided with operating addresses as private wagons used by the Deutsche Bundesbahn, which makes it credible for use on Epoch IV systems.

The same applies to the "Graf Stolberg Dunkel" follow-on wagon (98161), now also available, which differs only in its deep black exterior colour (RAL 9005), the beer glass and bottle motif and of course details in the lettering. Both models were printed digitally.

If there is sufficient demand, these cars will be completed to a series of three, i.e. a suitable beer wagon, also designed close to the model, with product advertising from the Westheimer brewery is still to follow. By the way, there is a suitable brewery as a layout motif at Lütke Modelbahn.

The Märklin advertising wagons are available exclusively in the 1zu220 shop (<https://www.1zu220-shop.de>) while stocks last.

The latest news from American Z Line:

In July, the third nostalgia model of the Genesis diesel locomotive from Amtrak (Art. No. 63509-1) was also delivered, which now represents Phase III.

Of the AAR freight cars built in 1937, a Louisville & Nashville inscription variant is now available as single cars (904307-1) and in packs of two (904377-1) and four (914307-1). The same packaging of this type also applies to Southern Pacific (904313-1, 904383-1 and 914313-1).



Nostalgia model no. 3 for the 40th anniversary of the Amtrak in 2011. Photo: AZL / *Ztrack*

Finally, 40-foot wagons with external box frames will be available for the Northern Pacific in the summer of 2018. Again, identical combinations were selected (903110-1, 903180-1 and 913110-1).

Further manufacturer photos of the current deliveries can be found at <http://www.americanzline.com>.

Arts and crafts for building models:

Barbara Finsterwalder is actually at home in size H0. About five years ago, she started building her own buildings and continued her training, a classic self-study, so to speak. Since she was previously employed in an architectural office, there was already a solid basis for building model construction. Her education and personal interest in art and architecture benefited her.



So far, however, she has only made her small works of art for her husband's large model railway system.

At an exhibition of the Schelklinger Modellbahnfreunde he showed his steam locomotive depot, while she worked on 1:87 scale buildings. Dietmar Stähler, chairman of Stammtisch Untereschbach e.V., asked enthusiastically to try his hand at a small hut for the Z-gauge.

Barbara Finsterwalder dared the experiment and started. Already the next morning she was able to present a result.

The enthusiasm was aroused and so it went a little further at his request at home. We would now like to present the result in the form of a Bavarian barrier post to our readers at this point.

Barbara Finsterwalder has now given herself a distinctive feature with the name Manufact Model Architecture. Since she is basically open to all, she is curious to see whether there is interest and demand from the circle of the Zetties.

A business or internet site does not yet exist; as things develop here, the response to this announcement will show. However, the crafts woman has



The successful first Manufact product in Z gauge. All sides of the building are shown in the two photos.

one idea in any case: the object of her work should remain individual personalized pieces, which are made by hand on the basis of photos or rough measurements. You can contact her at [bf.manufact\[at\]gmx.de](mailto:bf.manufact[at]gmx.de).

Märklin deliveries:

The electric multi-system locomotive ES 64 F4 from Siemens is now delivered with the black MRCE paint (Art. No. 88195). The model of this locomotive, which is identical to the DB 189 series, has been leased to SBB Cargo International, which also justifies its use outside the Swiss Confederation.

Cables and insulators on the roof were sprayed in two colours, but still do not come close to the first editions, where the differentiations were finer and also the printing, especially in the half-timbered area, was more extensive. This time again, the once well-received red lower scissors will not be replicated.

The bogie frames are not correctly produced because they show the yaw dampers on the wrong side. This was avoidable, because Märklin has the correct execution in their mould stock. The driving characteristics are beyond any doubt, however, as this model now also runs with a bell-shaped armature motor and flywheel.

Pause at Schrax ended:

After a long creative break, 3D printing provider Schrax (<http://www.schrax.com/de>) is back with new items. The manufacturer describes its electronic distribution with a new structure as the largest of these. Under the payment options, a cash discount of 3 % is granted on prepayment.

The transformer house was already announced before the creative break, of which only a few individual copies had been produced. Now the small building with plaster facade, two insulator panels at the front and rear as well as a flat plain tile roof are also available. However, this building model from Era III can be used in many situations.



The transformer house from Schrax in all common sizes. Photo: Schrax

On our own behalf:

As announced, the change of our technical site operator was completed at the beginning of July 2018. Thanks to the energetic help of Stephan Bauer, this went smoothly and silently, so that our readers probably did not notice this.

Our accessibility via e-mail was also quickly restored and was almost as seamless. We would like to take this opportunity to thank Stephan Bauer for his help and support and hope that he will continue to help us to establish secure connections and switch to a modern CMS system in the future.

We have also had the opportunity to gain initial experience with the new provider's support services. Compared to our former partner, we were pleasantly surprised by the fast and competent contact.

Accessories at Ztrack:

Ztrack (<http://ztrack.com/>) now offers different design parts from the production of **Ztrains** in its program. These are unpainted raw parts such as bridge abutments (Art. No. ZTR-100 to -103), tunnel entrances (ZTR-110 / -111) and loading ramps (ZTR-130) according to the American standards. In some cases, they can also be easily integrated into European layouts.

Revised 3D printer at Conrad:

Renkforce has redesigned its 3D printer RF2000 and now Conrad (<https://www.conrad.de>) presents a version 2 with an even larger and further improved range of functions. Now, according to its distributor, it is suitable from the ground up for use in professional environments.

It has a dual extruder that can print miniature objects for the model railway as well as highly complex components and filigree parts for other applications.

Compared to the first version, the pressure chamber of the RF2000 v2 model has been enlarged. In addition to a patented, fully automatic pressure bed calibration, the device is also equipped with a high-precision mechanism with linear guides and industrial standard recirculating ball gears.

An unannounced FR wagon innovation:

The open freight car of the standard type Eanos is now available from FR Feinwerktechnik (<http://www.fr-model.de>) in an Italian state railway FS version (Art. No. 39.337.01).

A one time series of 40 models of this version was produced. The technical design corresponds to the variants already available, which is why the load inserts designed by Josephine Küpper for this type of construction also fit.

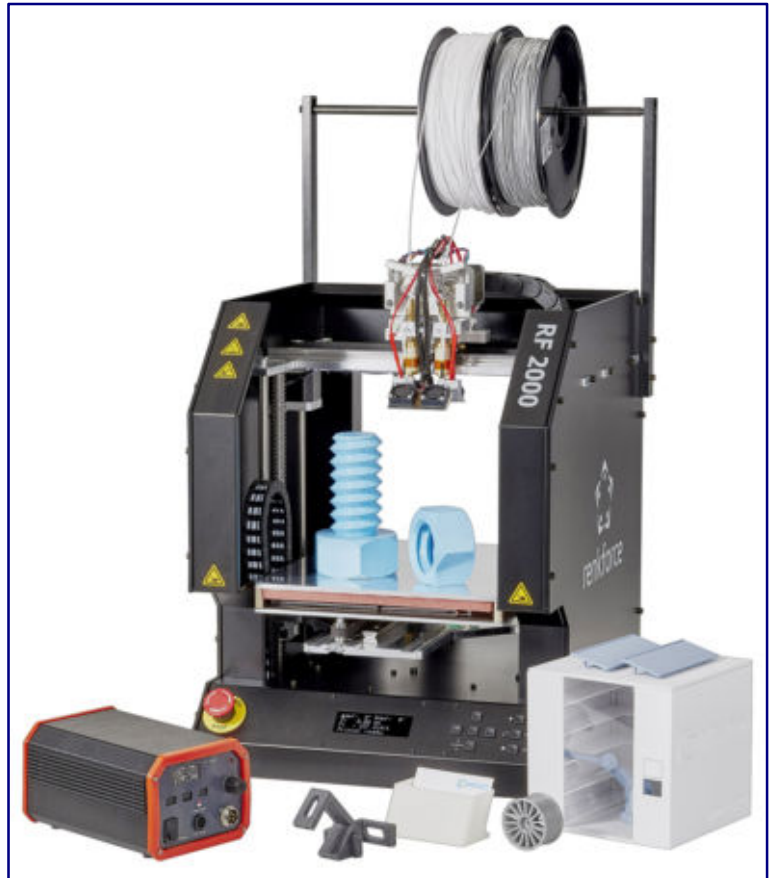

Maximum productivity and durability - The RF2000 v2's mechanics and electronics are manufactured to industry standards and designed for continuous operation. Photo: Conrad Electronic



The Eanos of the FS (Art. No. 39.337.01) expands its fleet of vehicles based on Italian, German or Swiss models, since this type of vehicle is used internationally. Photo: FR Feinwerktechnik



This is the new edition of the DB container wagon Lgs 580 (49.346.11). Photo: FR Freudenreich Feinwerktechnik

Another DB Cargo Lgs 580 container car series (49.346.11) will also be completed this month. This is an identical model to the special car sold in Altenbeken, painted traffic red and loaded with a P&O Nedlloyd container.

Another example is in preparation for an exhibition in Bad Schwartau in early 2019, which will carry a brand-new 45R1 refrigerated container with advertising design for Schwartau jams.

At the time of going to press, SBB's new ballast wagon Xas73 (41.345.12)

was also due for delivery in two packs. It is a version in ordinary, dust grey paint and both cars have different car numbers.

As an immediate clearance sale from the manufacturer became apparent shortly before the start of this delivery, FR is already preparing another package (41.345.22) with again changed car numbers, which should be completed at the beginning of August.



New ideas from Spur Z Ladegut K pper:

Helmut K pper was also creative again and can offer new goods for his customers. The wooden elements (Art. No. Z-159), which can be transported on M rklin's low side wagons 8610 and similar types, are stored vertically and well secured.



The "5 sewer pipes" (Z-160) are also intended for the same type of wagon, which, as concrete parts, already had a higher weight on the model. Even heavier loads can be transported on wooden pallets (Z-PAL) on pallets.

Wooden elements (Art.-No. Z-159; photo above) and 5 sewer pipes (Z-160; photo below). Photo: Spur Z Ladegut321 Josephine K pper

The design of Josephine K pper's Z scale load (<https://spur-z-ladegut.de>) is based on the Euro pallet, but it is made of real wood for the intended use on freight wagons and is considerably larger and more stable.

Imprint (Legal Information)

ISSN 2512-8035

Bibliographical information of the German National Library: The German National Library lists this publication in the German National Bibliography. Detailed bibliographic data and editions are available in the DNB catalogue at <https://portal.dnb.de>.

The publication of **Trainini Praxismagazin für Spurweite Z** including **Trainini German Magazine for Z Gauge** is voluntary and non-commercial. **Trainini Praxismagazin für Spurweite Z** does not seek revenue streams. This publication is subject exclusively to German law and justice.

Contributions identified by name reflect solely the personal opinion of the author. This is not necessarily identical with those of editors or publishers. Photos were taken, unless marked differently, by the editorial office.

Editors:

Holger Späing (Editor-in-chief)
Dirk Kuhlmann
Joachim Ritter

North America Correspondent:
Robert J. Kluz

English translations:
Alexander Hock, Martin Stercken

Further, volunteer work: Michael Etz (**Trainini Lokdoktor**), Andreas Hagendorf, Torsten Schubert

Publisher and responsible person under German press law is Holger Späing, Am Rondell 119, 44319 Dortmund; Contact: Tel. +49 (0)231 95987867 or by E-Mail at [redaktion\(at\)trainini.de](mailto:redaktion(at)trainini.de).

Events & advertisements of third parties are free, but are subject to availability & recognizable Z gauge relevance. They appear separately from the editorial part at the sole responsibility of the advertiser. Priority is always given to ads from small series producers.

Letters to the editor must be submitted in writing by mail or e-mail to [leserbriefe\(at\)trainini.de](mailto:leserbriefe(at)trainini.de) stating the full name and address of the responsible reader and are always welcome. The publication remains reserved for the editors. The editors endeavour to always give a representative picture and therefore to consider every entry.

When submitting images, photos and drawings, the transmitter agrees with the publication and exempts the publisher of possible claims by third parties. This includes a future repetition in the magazine, annual video as well as in brochures & posters explicitly.

All company names, trademarks, and designations mentioned in this publication belong to their respective manufacturers or rights holders. Their reproduction takes place without guarantee of the free usability. The editors and publishers assume no liability for misprints, errors, price information, product designations, construction diagrams or transmission errors of any kind whatsoever.

Trainini Praxismagazin für Spurweite Z is published monthly (without guarantee) and is available to all interested model railroaders, especially friends of the Z Gauge, free of charge and for a limited time for download at <http://www.trainini.eu>. Download may incur third party connection and network service provider costs. Posting only the full magazine on other domains is expressly allowed after removal from your own pages, as long as the download is not offered for a fee.

All posts, photos and reports are subject to copyright. Translation, commercial printing and any other kind of reproduction, even in part, assume the prior explicit consent of the publisher. Especially unapproved, commercial exploitation will not be tolerated.

Trainini® is a registered trademark, registered in the register of the German Patent and Trademark Office (Munich), No 307 30 512. Brand owner is Holger Späing, Dortmund, Germany. Misuse will not be tolerated. All rights reserved.