

*International Edition*

Free,  
electronic magazine  
for railroad enthusiasts  
in the scale 1:220  
and Prototype

[www.trainini.eu](http://www.trainini.eu)

Published monthly  
no guarantee

ISSN 2512-8035

# Trainini

German Magazine for Z Gauge



**Holiday mood in model**

**Scaffolding work on the V 36**  
**Model car history**

## Introduction

Dear Readers,

summer seems almost over to me as I write these lines. But it can't have been all yet, can it?

That's right, many of our readers are still on vacation. In some German federal states there are still summer holidays. And so we also want to see a summer edition for August, in which holidays and wanderlust echo.



**Holger Späing**  
Editor-in-Chief

But why wander into the far distance when the good is so close? Right, and so we found the perfect solution not far from the editorial office, with which we could reconcile our ideas. Our reader Dietmar Allekotte lives less than 50 kilometres from the editorial office, and his diorama "Küstenland" (coastland) had everything we imagined by theme.

I am all the more pleased to be able to present it to you today. After all, the works of our readers are what we would like to focus on in our reports this year. I therefore think that you will feel the same excitement when you read them as we do.

It was midsummer and hot when we visited Herpa in Diethofen not quite two months ago. After all, we don't want to miss a round anniversary. We offered there our popular hobby activity for children, in which they can give a beer mat a small landscape and experience so first contact with the model building.

Noch and Uhu have generously supported us as sponsors again, for which I would like to thank you at this point. We were also able to capture many personal impressions and most of all pictures. Therefore you will find a report in this edition.

A further topic is to be the V 36. As a locomotive with roof cupola it was almost a small sensation in spring, but a few things are still missing for an original-oriented model railroader.

So we started with a model construction kit from Exact and equipped a model with it. We would very much like to show in this edition's tinkering article that the parts produced in small series and carefully varnished and mounted considerably enhance the Märklin model.

But August is also full of news and novelties. This time there are many pages in the section where we would like to stay in dialogue with you. Our two book reviews are not quite as recent, but they really pack a punch. If we had to decide for one of them, we would probably have a hard time.

This brings me to the last missing topic: With the VW Transporter we are turning to a special car that has shaped and continues to shape everyday life on the road as well as on model train layouts. A short history and model overview should therefore show the entire spectrum of how we encounter the "Bulli" again and again. Have fun reading!

Sin-Z-erely,

Holger Späing

## Editorial

Introduction ..... 2

## Model

Optimization potential detected ..... 4  
Retired transporter ..... 18

## Prototype

Currently no items

## Design

On the North Sea coast... ..... 34

## Technology

Currently no items

## Literature (not translated - only in German)

Car legend - legendary car ..... 40  
Youth on a big trip ..... 42

## News

The sun smiles for the anniversary ..... 44  
Zetties and Trainini in Dialogue ..... 52

Imprint ..... 67

We thank Dietmar Allekotte, B. and N. Heller, Raffaele Picollo, Jens Wimmel and Sascha Braun for their photos.

Date of publication of the German language version of this issue: 26 August 2019

### Cover photo:

In places it is close to this coastal section and the railway line borders directly on the beach promenade. Swimmers cross the line over the pedestrian bridge in the background, while VT 98 9667 roars loudly past them.

## Upgrading work on Märklin's V 36 Optimization potential identified

*Without a doubt Märklin's V 36 is a successful model. But the missing handrails on the front turret and the ladders, which can certainly be better modelled, still offer potential for all those who take it very seriously or want an almost perfect locomotive. The latest edition as 236 123-6 also lacked a horn. With the help of the Exact-Modellbau modification kit, we have now eliminated these small mistakes, as well.*

With the V 36, Märklin has delivered a good design and put another desired model on the rails, which has already been released in four different versions. But even this locomotive still offers some ideas for our modifications. Whoever would like to transform, for example, from the 236 123-6 with roof cockpit (Märklin 81772) into a top model, can do so with a limited expenditure.

Exact-Modellbau from Bad Doberan has developed a special modification kit (Art.-No. 19.10.3.11.1) for the DR-version of the diesel locomotive, which contains missing or improved parts for the Märklin-model. It is distributed exclusively by Z-Railways.



With the kit of Exact-Modellbau (Art.-No. 19.10.3.11.1) you can get a lot out of Märklin's Kanzeldiesellok (roof cockpit diesel locomotive) 236 123-6.

With this kit I have upgraded the locomotive so that it can be introduced once again. First, I scan the supplied nickel silver plate, and obtain an overview of the scope and effort: I find a folding ladder, two pairs of one-piece coupling rods, seven shunting handrails and a drilling template.

Also included are two horns as brass castings. A set of coupling rods, three rods for the hand rails and one of the horns are therefore intended as a replacement or surplus. The modeller will be thankful if something should go wrong, which may also encourage beginners.

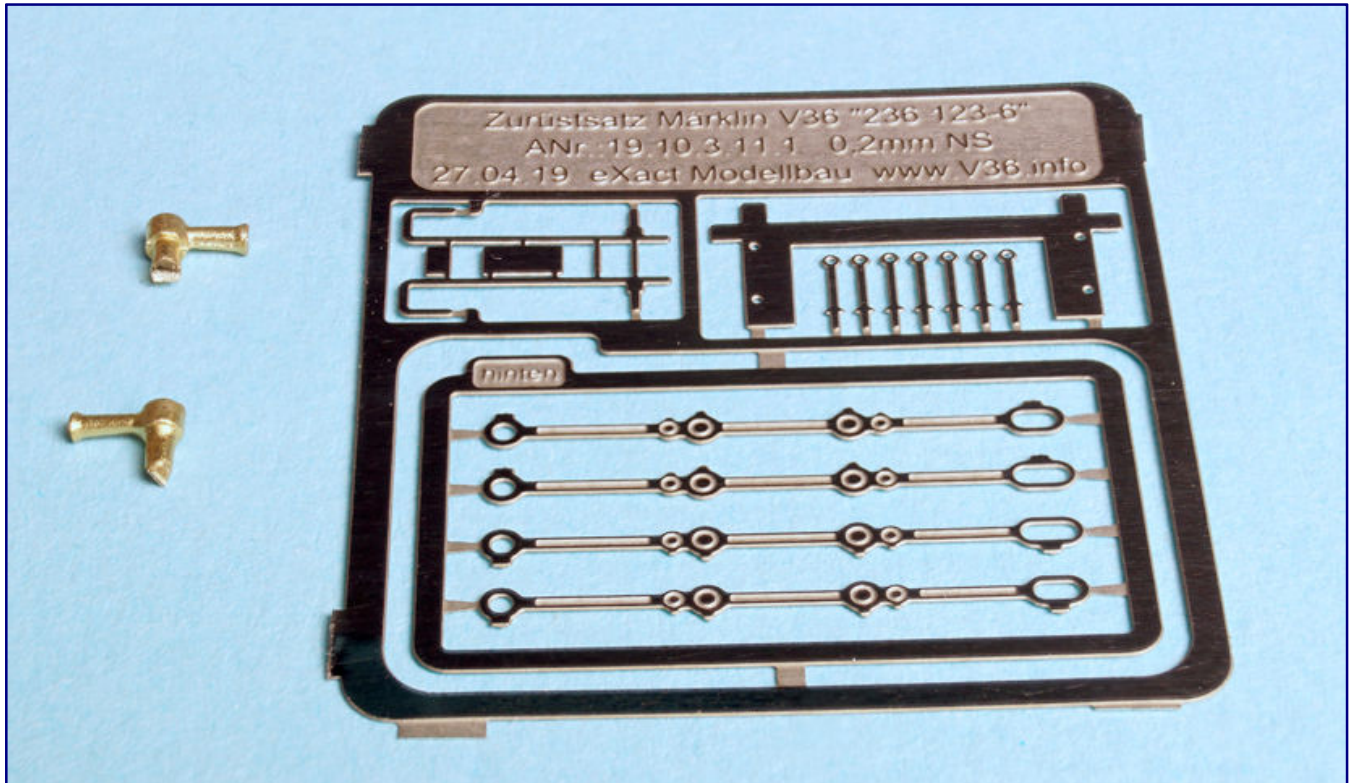

The parts set contains two horns made of brass investment casting (left) and a nickel silver etched sheet metal bow with drilling template (top right), and all necessary parts. If only one shunter hand rod was included, a second model could be completely upgraded without replacing the ladder.

Soldering work is obviously not required. The modelling work is limited to separating, folding, painting and attaching parts. If you already have experience with etched parts, you should not encounter any problems here.

And that's where it all starts: Painting is best done while the parts are still attached securely to the sheet. That's why I only cut out the drilling template, which is supposed to help with the correct positioning of the shunter handrails. It will be set aside for the later work steps.

## Basic painting

All parts still left on the sheet, as well as the parts made of brass investment casting, require painting. Due to the smooth surface, which offers little adhesion, not all paints and varnishes are suitable for metal.

This requires a good choice and pre-treatment of the surfaces. So there must be neither dirt nor grease on them. While the former is not an issue, grease from our hands plays an even greater role: if we take the sheet out of the bag without gloves, we could leave invisible traces which can impair or even prevent the adhesion of lacquers.

Ideally suited for degreasing is acetone, which should be used carefully because of its volatility and toxicity. With good ventilation, we wipe the sheet from both sides with a bristle brush, the tip of which is

first moistened with the solvent. Tools, such as tweezers or pliers, should be used to avoid contact with the skin.

Touching with the fingers is now taboo. If everything is gone, I fix the coupling rods with Tamiya masking tape, so that they remain immediately free of paint mist. Ladders, shunting rods and a horn are now primed black on all sides with an airbrush, while they are held by a "third hand".

A (unfortunately no longer available) nitro-based Modelmates primer is used which, like Badger's black PU primer, shows no colour deviation from the deep black base of the Märklin model.

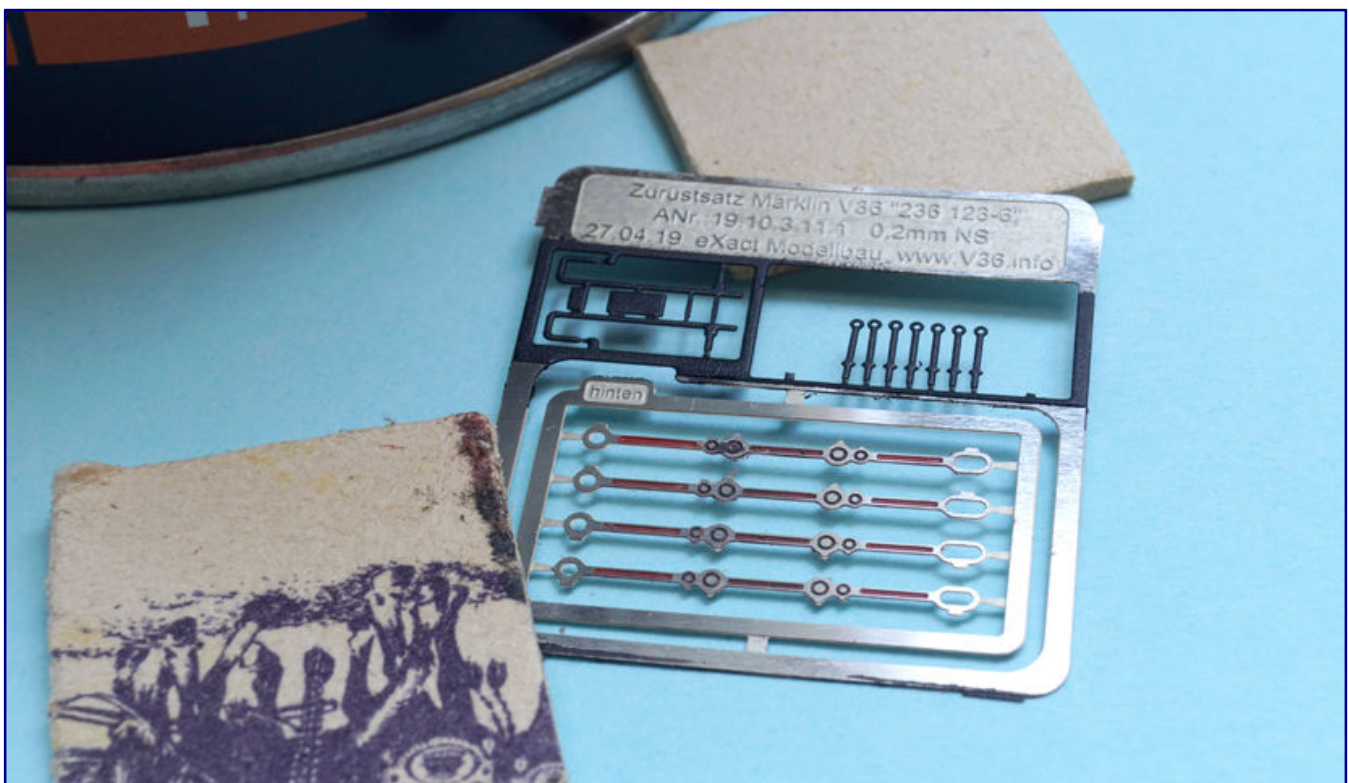

All parts to be mounted later on the black superstructure have been spray painted on both sides in RAL 9002 deep black, the coupling rods, on the other hand, are painted fire red with a brush. After drying, they are removed together with the black rod bearings with a piece of beer mat which has previously been moistened with nitro thinner.

As soon as the spray application is surface dry, the masking tape is removed. When you are certain that the freshly painted parts cannot accidentally touch, work with the coupling rods can continue. However, these can only be painted with a fine brush.

I paint the parts milled in the model as exactly as possible in RAL 3000 fire red, the axle bearings I emphasize with RAL 9002 deep black. The black varnish may be mixed a little more liquid, because full coverage is not required. I see the water-based products from Oesling Modellbau as the means of choice here.

Of course, no matter how small the brush tip, it is not possible to reach all parts of the poles so precisely that the parts could be used immediately after drying. So I put something into the trick box to put the surfaces that should appear blank back into this state.

Traditionally, the finest sandpaper with a grain size of at least 1,000 was always used here. But since this also leaves tiny grooves on the surface, I received a helpful tip from Ronald "Larry" Schulz (Exact-Modellbau): Use an absorbent piece of drawing cardboard that has been carefully sprinkled with nitro thinner.

It must not be wet or even dripping; a slight surface moisture is completely sufficient. So I cut a piece out of a beer deckel (mat), which is supposed to be even more absorbent, and carefully wipe the sheet with it. It lies flat and safe on the work surface of the table.

In no time at all, the excess paint disappears from the raised surfaces, leaving behind red depths and black bearing rings -- perfect! Later, a tarnish protection of silk matt clear lacquer, applied with the airbrush, will permanently seal this movement.



In addition to the Xuron tweezers, the Tamiya bending pliers are particularly useful for the necessary bending work, as shown here with the drilling template.

Next I turn to the ladder. Märklin's punched part on the left side of the ladder can't satisfy my expectations at close inspection: It lacks the climbing protection that was provided by the "Doppelten Lottchen." In addition, the basic shape can also be represented much better with an etched part.

So now the ladder is separated from the arch and bent. A pair of Xuron tweezers and Tamiya bending pliers help me. The sides are quickly angled precisely, the top step is only brought into shape later, as soon as the assembly takes place.

It's also satisfying that the primer shows a good hold and doesn't come loose at any point. Only at the outer bending points will smaller repairs be necessary, because the application now shows less coverage because of the stretching.

Meanwhile I can think about the assembly of the parts on the model. I am still undecided whether I should actually mount the new coupling rods? Although the short parts from axle to axle give a good and straight

picture to the reference model, the original part looks better, because it shows more details like the rod bearings and the lubrication tanks.

But my insecurity is fed by the fact that Märklin's chassis is dark nickel plated, but the new rod is bare and will therefore stand out clearly. Will that look appealing? But there's still some time until then, because more work has to be done now.

## Partial disassembly of the Märklin locomotive

In order to be able to do the necessary preliminary work on the model as well, the locomotive must be partially dismantled. The housing must be removed, otherwise, the ladder cannot be removed.

To do this, loosen the retaining screw with which the hood (bonnet) is fixed to the chassis block from above.

However, it can only be accessed if the plastic cover fitted over it is removed. It reproduces the longitudinal flaps through which the engine was removed when the prototype was opened.

Unfortunately, it sits very tightly and can only be removed with a lot of sensitivity and patience.

Tools are out of the question, because they would have to be very flat to get under the edge and would leave scratches on the paint, or even grooves if they slipped.

Therefore please do not use blades or screwdriver tips! With a fingernail, it takes a little longer, but the necessary fingertip feeling is maintained in the truest sense of the word.

If one end only lifts a little, you can carefully pry it until the cover inserted into two openings can be pulled upwards. The screw is then accessible and can also be loosened.

Inside, I discovered another disturbing factor with the LED board, and found that it is tightly glued to the case together with some foam and the lower light guides. But this construction can be easily removed and later fixed again by lightly pressing on it.

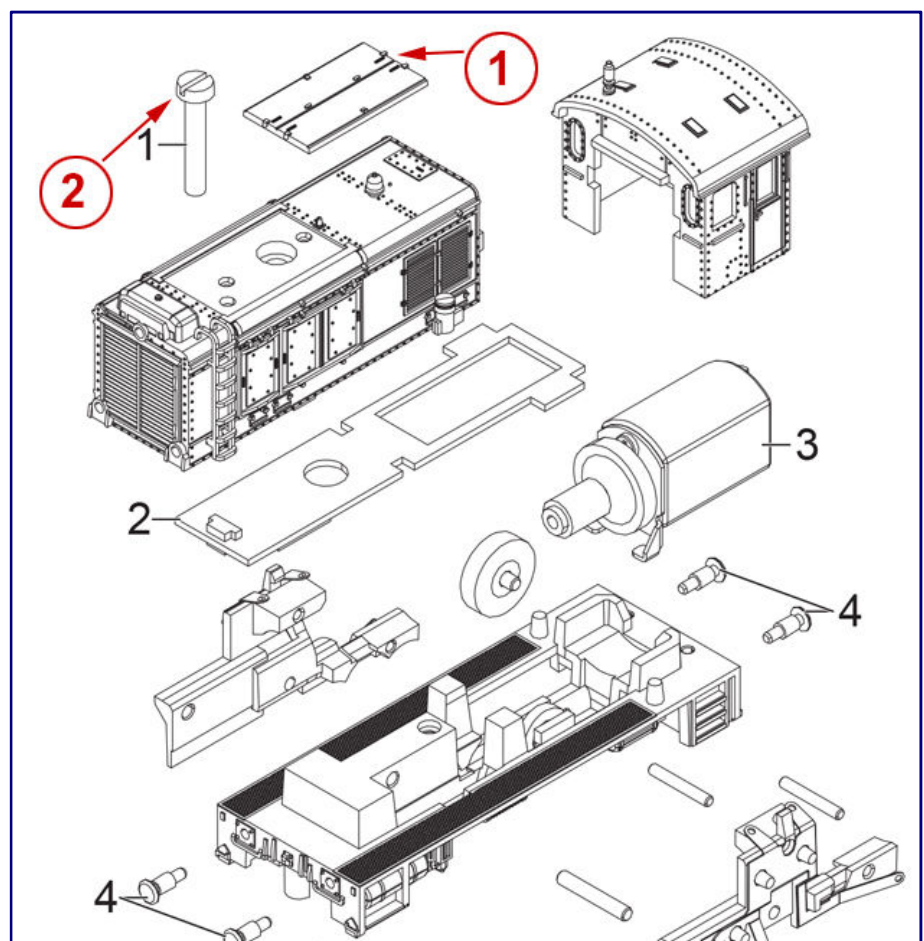

The extract from the exploded view illustrates the assembly principle and thus the individual steps of disassembly: In the first step, the flap replica of the hood must be lifted off in order to reach the housing screw. This can then be loosened in a second step to unhook and remove the complete engine hood from the driver's cab. Illustration: Märklin



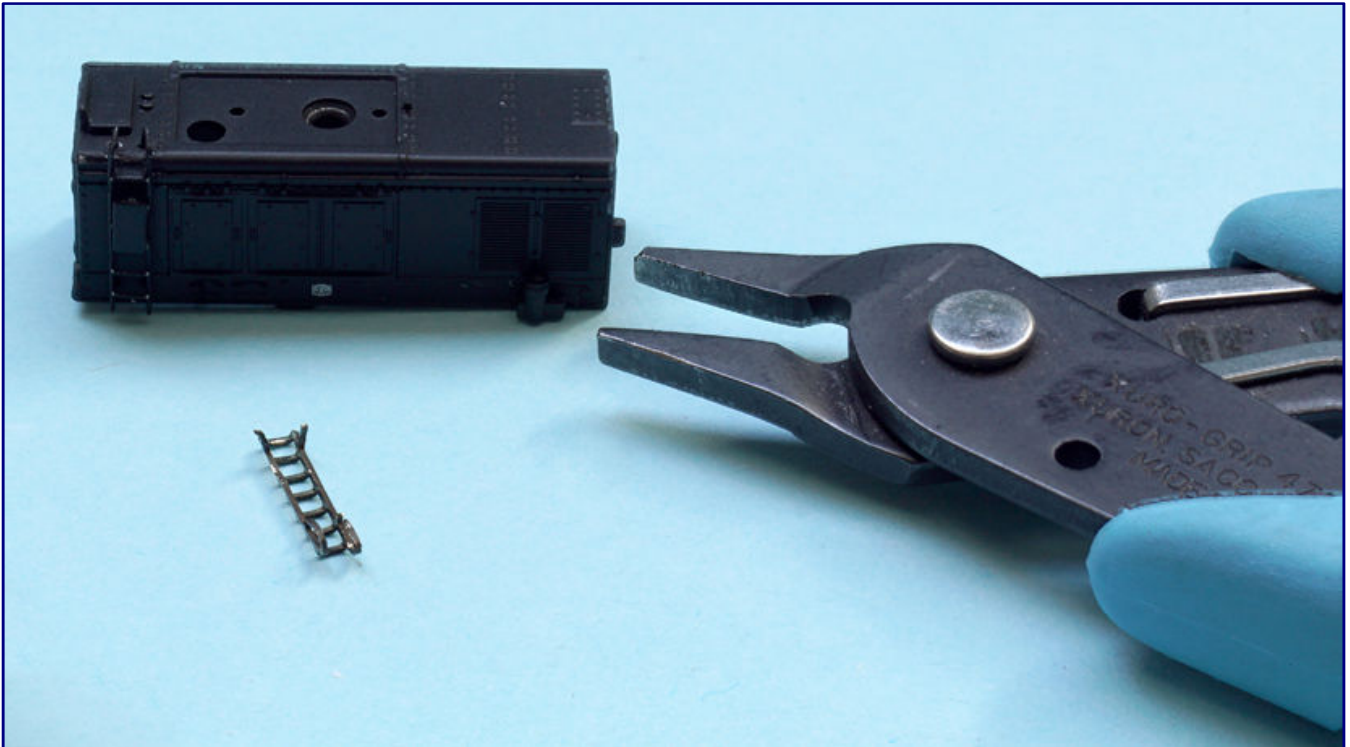

The disassembly of the stamped ladder (picture above; lying in front of the locomotive housing), with which the model was delivered, is difficult because the inside bent ends are difficult to prise open. Once this has been done, a dry fit test is carried out, which can show any necessary readjustment or re-drilling of the receptacles. Once the new ladder is mounted (photo below), its ends are also bent to the inside, and additionally fixed with a drop of glue.

Somewhat annoying is the fact that the four brackets of the ladder, which are bent inside, cannot be prised open. They are too tight to reach underneath. I have no choice but to pry from the outside to put some pressure on them, and at least bend them a little.

With regard to the sensitive varnish, only a toothpick or a comparable piece of wood remains as a tool. Better sacrifice a few toothpicks than ruin the expensive model! With patience this step is finally successful and you can go on with the "reconstruction".

## Face-shaping assembly work

The assembly activities take place parallel at the chassis, on which otherwise only the driver's cab sits, and at the bonnet. I would like to start with the installation of the manoeuvring rods. Ronald Schulz has drawn a drilling template and integrated it into the etching sheet so that they can be placed exactly at the same height on both sides of the vehicle.

This auxiliary tool has a positioning angle at the front end. Four flaps of the sheet metal are bent around 90° with the bending pliers, in each case two of the short strips then together form a corner. We place the tool on the front circuit board of the locomotive, and hold it there precisely in the correct position.

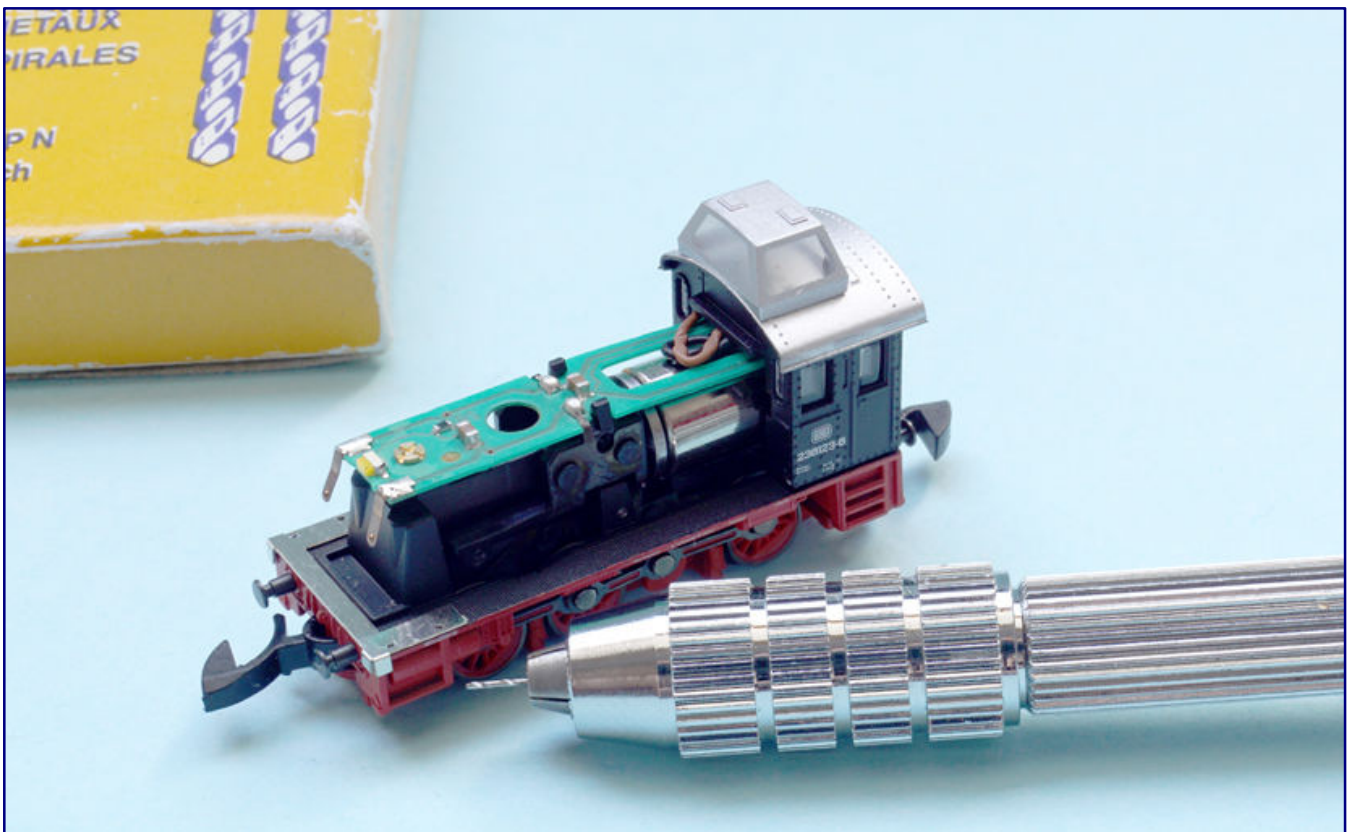

The drilling template can be placed precisely thanks to the angled corners. When drilling the holders for the holding rods, however, it should also be fixed with light finger pressure.

However, it still doesn't work completely without pressing with one finger, but somehow the model and drilling template have to be held with one hand anyway, while the other one guides the pencil vise with a 0.4 mm HSS twist drill.

Four holes are to be drilled in this way. I have already removed a holding bar from the etching arc with the nail scissors in order to check the drilling depth repeatedly. After all, the circulation has only a small thickness. If the short shaft disappears up to the widened foot in the drill hole, the suitable depth is found.

Nevertheless, what should be avoided here happens during a single pass: The tiny drill goes through the hole and causes a scratch on the battery box underneath. Fortunately, this spot can be easily repaired later with a drop of RAL 3000 fire red and is then only visible to those who know of this mishap. The correction then takes place when the sleeves of the buffers are reworked in the same colour.

First of all, nothing stands in the way of gluing the shunter poles with a tiny drop of Uhu glue Super Strong & Safe. The selected adhesive is very resilient when dried and allows minor corrections for a short time. But it is also chosen because I consider it to be a more durable adhesive than pure cyanoacrylate (superglue).

During the drying process, a fit test of the already painted and folded ladder is carried out on the hood. While the factory openings on the left side show no problems, it hooks on the top side. Therefore I drill these two holes also with the still bordered drill. 0.3 mm diameter would have done it already, however, as I recognize later.

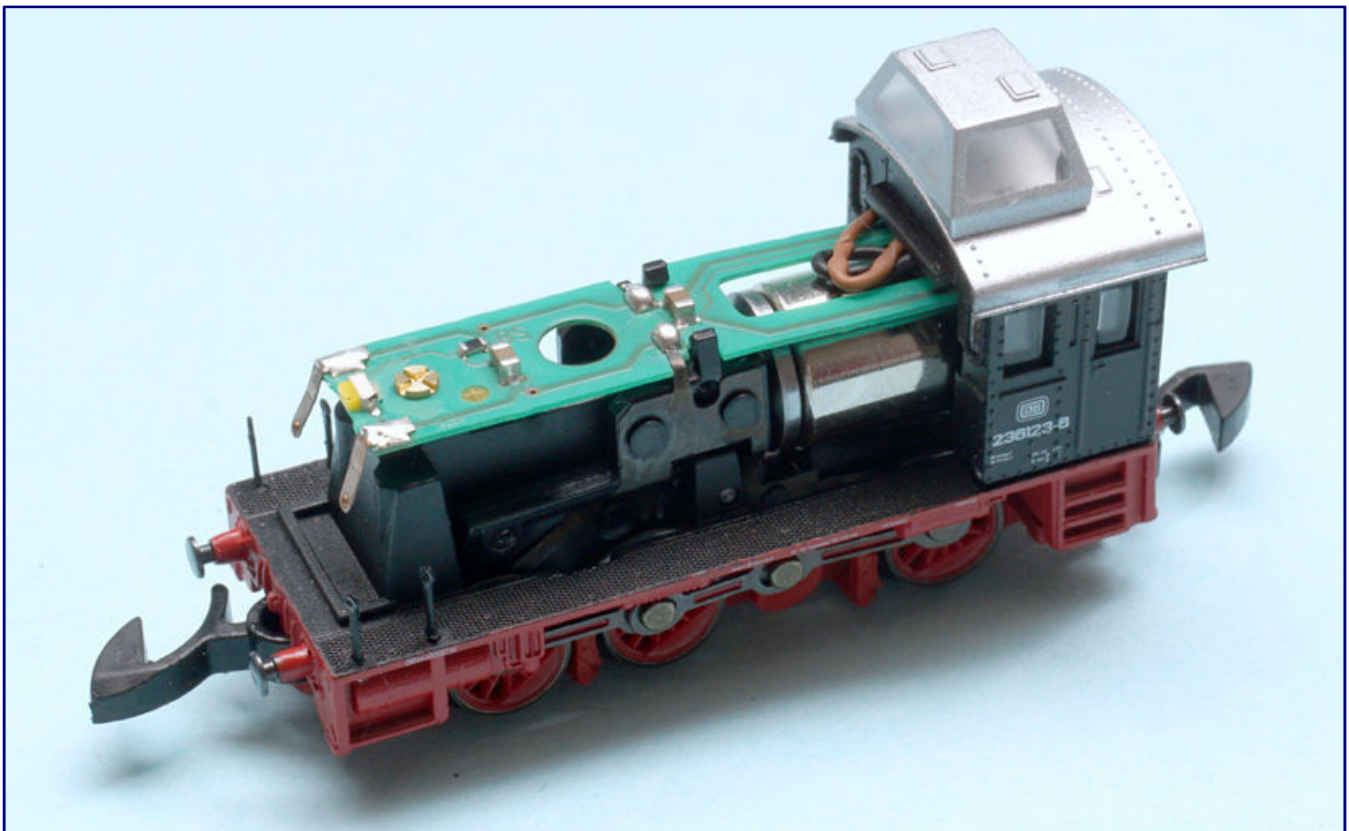

The four poles on the right and left stairs are inserted and glued. If necessary, their alignment can be readjusted as soon as the housing has been replaced.

Now the ladder is attached, whose inner ends are then bent over and glued with a drop of the already mentioned superglue, also from the inside. After the glue has dried, I will cover it with black paint on the inside of the openings, because Märklin has also done something similar ex-works, presumably to prevent unwanted light leakage.

Research requires the horn, but its exact positioning is still unclear. Photos show that it sits on the hood and points diagonally forward to the driver's side. However, the exact mounting position must be determined.

Unfortunately, there are no drawings to be found, so all other photos that can be found on the prototype locomotive and similarly equipped sister locomotives must be used. These photos are unfortunately as varied as the operating numbers of the locomotives in question: At least three different positions can be determined for V 36 119, 120 and 123, at first go.

Finally, a photograph from which the concrete model locomotive was photographed from an elevated position helps to achieve success. In the comparison to a side view, it shows clearly that the compressed air horn is mounted at the point where a bell should otherwise be, or was previously located.

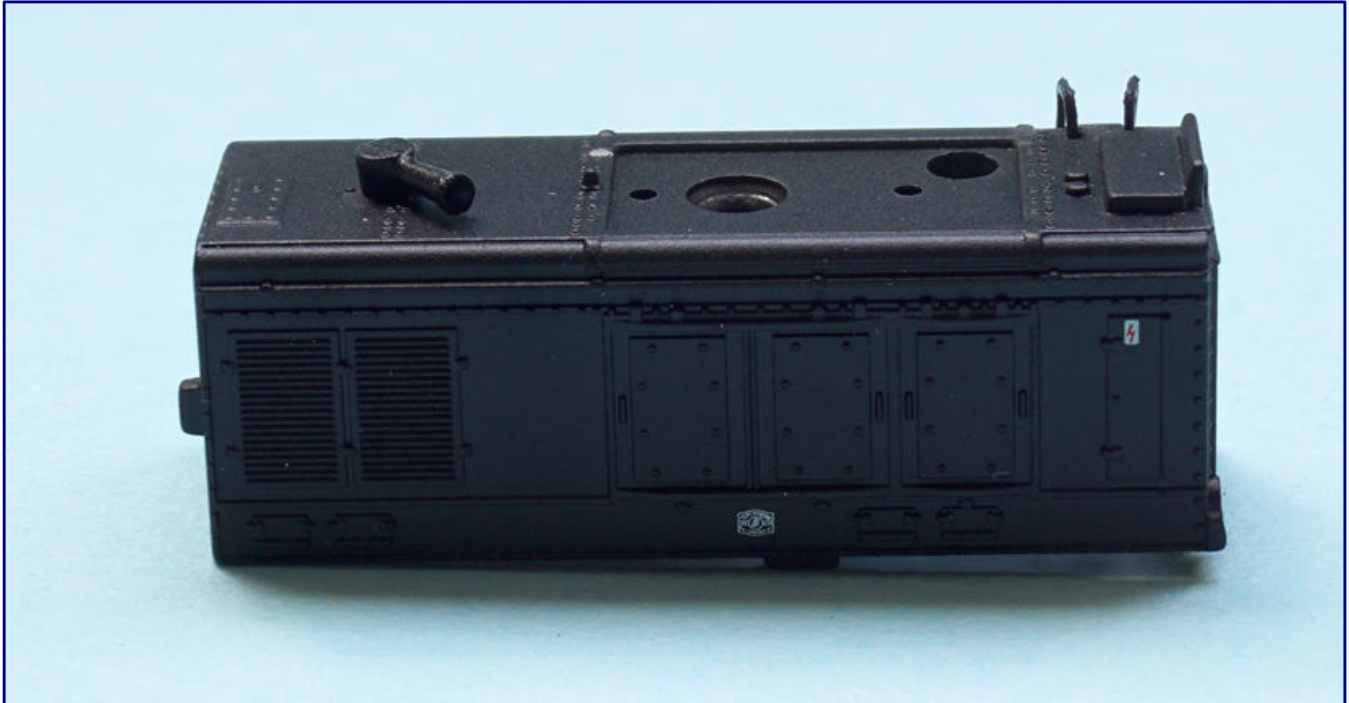

Some photo searches require the correct positioning of the horn on the hood. Finally, it is correctly located in a 1.0 mm diameter hole just in front of the driver's cab. There it points diagonally right and forwards.

This is also obvious in so far as a compressed air line has probably already been laid there. The economical Bundesbahn will certainly have spared further rebuilding requirements and continued to use them. On the Märklin model, this location is easily recognizable by a row of rivets (interrupted in the middle). The angle of the inclination can now also be determined more accurately with the help of the side view: it should be exactly 45°.

Next, I pre-drill the spot determined in this way with a diameter of 0.4 mm. This ensures that the drill does not run out and that the hole can be placed exactly in the middle. Then I widen it to 1.0 mm. Since the brass base does not yet fit properly and the horn cannot be inserted deep enough, I drill a second time with 1.2 mm diameter. The zinc die-cast part is of course worked on with the pencil vise again for the highest possible sensitivity.

After a successful fit test, I apply the Uhu glue Super Strong & Safe on the inside and insert the horn. Before the glue attracts and sets, I properly align it to the driver's side. The conversion in the area of the hood is also finished, and only minor touch up painting in this area may still be necessary.

## The completed work

When the conversion work is already in full swing, Ronald Schulz surprises with a set of slides "8 Blitzpfeil-Schilder" (19.10.4.12.1), which he has commissioned not only for the parts set used here.

The company Hartmann-Originale (HaO) is responsible for these decals. Resolution and print sharpness inspire me, because they surpass the decals which I have used so far: The sign set shows the red high-voltage arrow on a white rectangle with just 1 mm edge length on the longer side, so that it can easily withstand the view through a magnifying glass with 10x magnification.

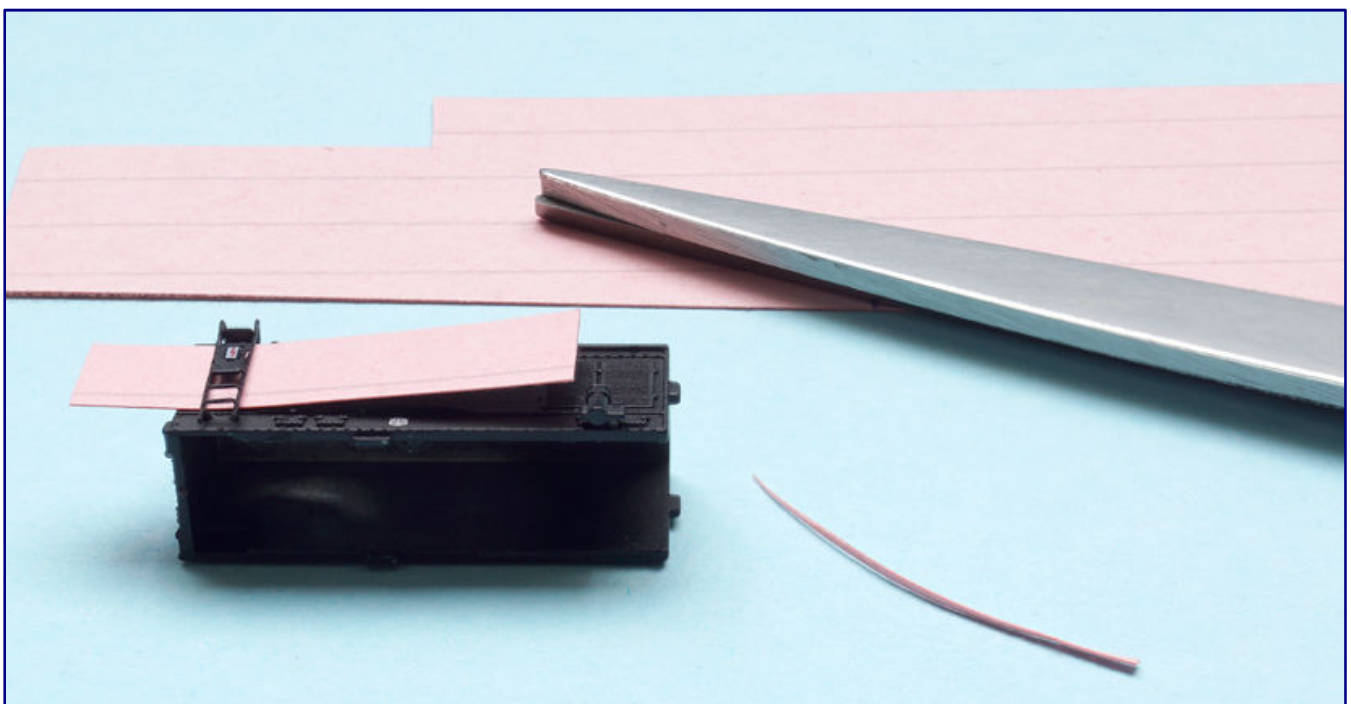

According to the original, a lightning arrow warning sign from Hartmann originals follows the protective flap of the access ladder (photo above). In order to protect it from damage and to seal it permanently, clear varnish is used, and the area to be worked on is masked. Below the ladder, a paper strip cut to size covers the surface of the hood (photo below).

It has also been thought through that the corners to be trimmed are marked with black printed angles at a small distance from the motif. White areas are otherwise very difficult to see on the light blue backing paper.

One of the eight arrows quickly finds its position on the ladder's climbing protection plate after the substrate has been prepared with adhesive fixer and the decal has been treated with plasticizer.

In a single operation with the coupling rods that have been reset so far, I plan to fix the dry decal permanently with silk matt clear lacquer. But I still have to come up with something to avoid fogging the entire case and possibly creating different degrees of gloss on the model.

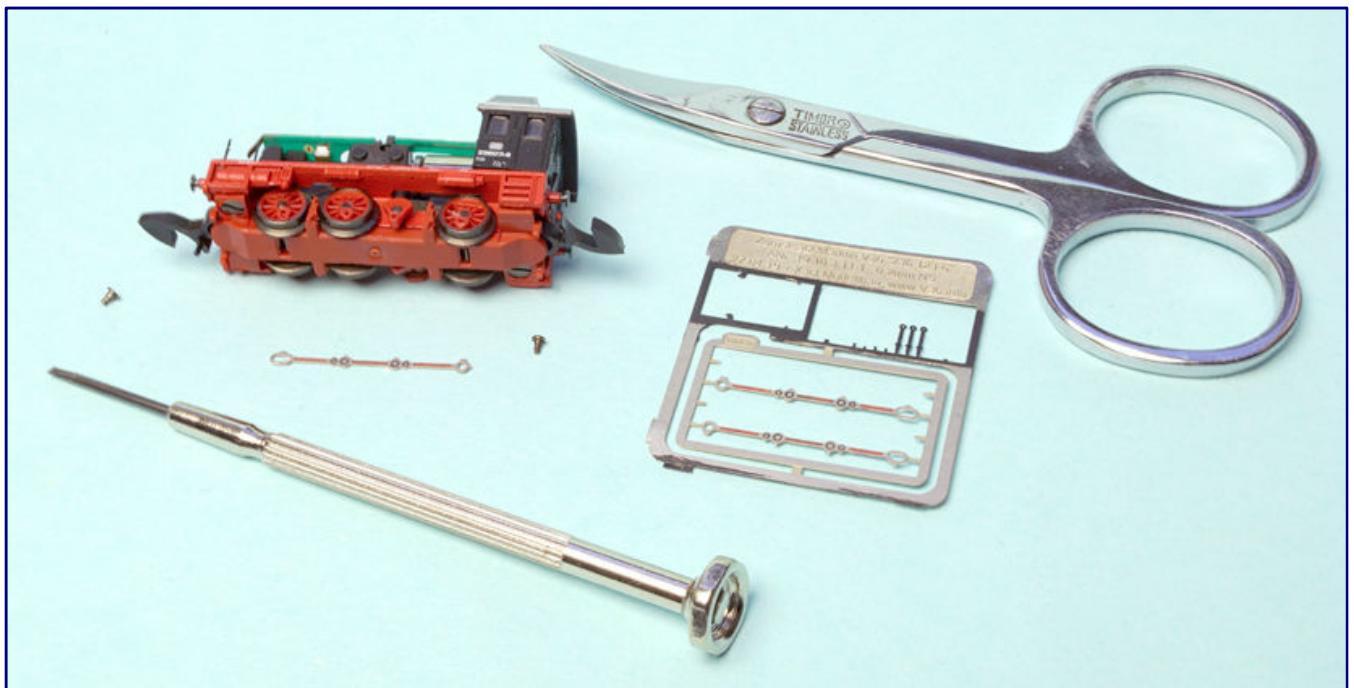

The new, one-piece rods from the parts set are fastened to the wheels with only two instead of four rivets. They are not only finer than the standard four-part coupling rods, but their design also guarantees a straight seat at all times.

The solution is a narrowly cut strip of thicker paper that I can slide under the ladder. It is held in place by simply gluing it to the Tamiya masking tape that protects the outer areas.

This step is also done quickly and the factory parts can disappear from the chassis. Carefully the holding rivets are prised off, and only the outer ones are used again. The rest is put together with the now loose rod parts in a bag and stored in the model box.

Now, cut a rod for the right and left side from the etching sheet (the rear end is marked on the sheet) and assemble it. Before carefully reinserting the rivets, I check the correct position: Are all the rod bearings in the right position (coupling pins on the wheel)? Are the lubricating vessel replicas pointing upwards?

With the completion of this step, the V 36 has gained a much improved appearance. The degree of difficulty is kept within manageable limits, which is why even model railroaders with little experience can dare to try this fine detailing.

Sudden questions, such as the location of the horn, can always occur. This obstacle was also mastered without any major loss of time. In the end, the result always compensates for all the trembling that can occur.

The only tricky part was painting the air horn, which was difficult to fix in the clamp of the third hand because of its short foot. If it popped out, a long search would be required.



The appearance of the model has been noticeably improved once again with the horn, the new climbing ladder including climbing protection, the handrails on the ascents and one-piece coupling rods.

For similar components, it would therefore be worth considering providing this casting chamber for a slightly longer period in the future in order to be able to more easily access all of areas of the component and paint it completely with an airbrush. It is easier to pinch off the part later, than to clamp the short end. But if you work with a brush, you will hardly be able to understand this suggestion, because the painting will perhaps only be done after the parts are mounted on the model.

But be that as it may, the thoughts are already circling on a very high level here. I was dealing here with a kit that was reasonably priced and well thought out in terms of construction, and that did not miss its mark! Therefore, it is only logical to nominate it for the best new releases of the year 2019 in the category technology.



Fully equipped, 236 123-6 returns to layout operation and now cuts a particularly good figure in front of switching trains.

**Basic model and reference of the finishing set:**

<https://www.maerklin.de>  
<https://www.shop.z-railways.de>

**Pages of the developer:**

<http://v36.info>

**Aids and tools used:**

<https://hartmann-original.homepage.t-online.de>  
<https://www.oesling-modellbau.com>  
<https://www.tamiya.de>  
<https://www.uhu.de/de>



# Eisenbahnfreunde Marsberg e.V.



Sa. 20. September 2019  
So. 21. September 2019



„Fahrtage“ in Westheim, Waldecker-Straße  
im ehem. Getränkemarkt



**Samstag 13 Uhr bis 17 Uhr**

**Sonntag 11 Uhr bis 17 Uhr**

- - Module und Ausstellungsstücke in allen Spurweiten
- - viel Betrieb auf der Modulbahn „Im Diemeltal“
- - große Faller Car-System Anlage

Für das leibliche Wohl ist natürlich bestens gesorgt

Unterstützt durch:

**DM Design**  
Planungen in Spiel und Freizeit

[www.eisenbahnfreundemarsberg.de](http://www.eisenbahnfreundemarsberg.de)

## The legendary “VW Bulli” Retired transporter

*Like the Beetle, the Volkswagen Transporter, referred to internally by VW as Type 2, dominated the West German roads during the early years of the Federal Republic. These vehicles have long since reached retirement age, but their descendants are still omnipresent today. Inevitably, this legendary car became a common sight on model railway layouts as well - clearly noticeable also in the Z scale world. Let's have a closer look at the prototypes and their Z scale reincarnations.*

The first prototype for the Volkswagen Transporter was built in 1948, and the new model went into production in March 1950. Regardless of which year is considered its official date of birth: This vehicle has long since reached retirement age.

For many years, VW referred to it internally as Type 2, because it was Volkswagen's second model after the VW Beetle (Type 1), with both designs sharing many features. The nomenclature is a bit confusing since everyone outside VW started the Transporter generation count with T1, T2 and so on. It was only from the 4<sup>th</sup> generation onwards, i.e. the T4, that VW itself also changed its internal nomenclature.



Its unique front design and two-colour paint scheme contributed to the characteristic look of the first generation VW Transporter. For a long time, the hinged double side doors were also part of the package, whilst the high bumpers were reserved for exported models.



The VW minibus came in many shapes and forms and not all of them were standard features. Many of the first and also second generation vans were particularly colourful as they became the vehicle of the hippie movement. The bumper slogan on this VW T1a is symbolic for the peculiar way-of- life of that generation: "Flashbacks happen". Photo: Marshall Astor (CC-BY-SA-2.0)

Right from the start, this small utility vehicle was a resounding success. Its close relationship to the Beetle, with whom it was sharing the same 25 HP Boxer engine, helped to keep costs as low as possible. With sales taking off, VW soon had to increase capacities and relocated its Transporter production from Wolfsburg to a new factory in Hanover on 8 March 1956.

The original idea for this bestseller is attributed to Ben Pon Sr., a Dutch VW importer. He is said to have proposed a light utility vehicle based on VW's Type 1 (i.e. the Beetle). The rest is history, with the Transporter soon dominating German roads in a similar way as its little brother. Its heydays were the fifties, sixties and seventies, but even today the current models are a very common sight.

The VW Transporter, in the German speaking world also known as VW Bus, Caravelle and "Bulli", has long since become a classic. Be it railway or postal services, craftsmen or hippies: they all drove it. Its most frequently used colloquial German name is "Bulli", which probably originates from a combination of bus and delivery van (in German "Bus" and "Lieferwagen"), and which at one stage was even on the shortlist for being its official product name.

In the English-speaking world, however, the nickname "Bully", never caught on, given the possible negative connotation of "bullying". Instead, it was often called "Splittie", alluding to its split windscreen.

One of the reasons why Volkswagen apparently did not officially go with the name "Bulli" was the fear of disputes with Heinrich Lanz AG, the manufacturer of the Bulldog brand for tractors. Moreover, the company Kässbohrer Geländefahrzeug AG also owned rights to the names "Bulli" and "Bully" for its snow groomers, for which it is a world market leader.



The minibus pictured here at a classic car meeting in 2009 in Zandvoort (Netherlands) is a VW T2b. These later versions of the second generation are recognizable by the short bumpers, which do not reach around the edges anymore, and turn signals which are positioned further up on the front side compared to previous versions. Photo: Alf van Beem (CC-Zero)

But branding issues did not stop the success of the Type 2, both on its home market and rapidly also on export markets. One of the main reasons for its success was versatility brought about by a range of varieties: minibus, panel van, emergency vehicle, camping version or as pickup with either single or double cab.

The VW Transporter's original design concept of an air-cooled and rear mounted engine survived up to the third generation and as such clearly outlasted the Beetle production in Germany. The T1 generation (1950 - 1967) still had hinged double side cargo doors, and sliding windows in the driver's and passenger's doors the side. Characteristic features were the decorative strips converging to form the V at the front with the large company emblem and the split windscreen.

With the T2 (1967 - 1979) the standard design changed to a sliding side door (previously available for the T1 from 1963 as an optional extra), windows that could be cranked down and one large windshield instead of a split screen.

The T2 also came with a much more comfortable cab, an improved brake system and more powerful engines, although we mention these features only in passing as our focus in a modelling context is more on externally visible features.

The switch to the third generation occurred in 1979. Produced until 1992, the T3 looked strikingly different from its predecessors.

Sporting a distinctly boxy shape, it was also bigger, more spacious and technically more advanced.

However, VW still held on to the rear mounted engine with rear transmission. Between 1981 and 1982, however, they were at least converted to water cooling.



The VW T3 with its boxy design was the last generation with rear-wheel drive, which was technically outdated but this did not diminish the great popularity of this model on the German market. Photo: Sven Storbeck (GPL)



The design of the VW bus has changed considerably over the decades - here a late T5 and to the right an early T4 – but it has always been popular with emergency services, here in the livery of the Deutsche Lebens-Rettungs-Gesellschaft (German Lifeguards).

The T4 generation (1990 – 2003) finally brought the Transporter into modern times. Having its engine moved to the front meant an end to its flat-faced design which had dominated the previous generations. The T4 now had a front-wheel-drive, but similar to the T3 from 1984 onwards, optional all-wheel-drive version was also available.

One of the big differences with the T4 Transporter was that it was available with two wheelbases and that it had - compared to its predecessors and thanks to its modified transmission concept - a cargo area which was of the same height throughout the vehicle, and which was significantly lower with the pickup version, thus offering a much better use of space.

The T5 (from 2003) and T6 (from 2015) generations merged seamlessly from one to another. On the outside, the Transporter has changed very little; the regular updates (2009 and 2015) then led to the new generational nomenclature at Volkswagen. The names for the different models are now Caravelle (minibus), Multivan (large-capacity sedan) and California (camper).

In Volkswagen's commercial vehicle segment, the van had and still has relatives against whom it has been and still is clearly distinguishable: above it the VW LT (1975 - 2006), known as the VW Crafter since 2006 and offering more space and a higher payload; and one size below the one-of-a-kind VW Fridolin (Type 147, 1964 - 1974), which had been designed for the German postal service.

## A generational question

In view of its strong presence (not only) on Germany's roads and its high popularity, it is hardly surprising that the VW Transporter also plays a major role in the world of Z scale.

After all, the Transporter was and still is a vehicle frequently used by postal services and police, making it a part of everyday life and as such an almost indispensable accessory for model railway layouts. In the early decades of its long history it also had hardly any competition and was therefore also the typical vehicle of choice for craftsmen and service providers.



The VW Transporter arguably had its most glorious days during a time when the customer was still king. It was the ubiquitous vehicle of choice for craftsmen and customer services in German cities during the time of Germany's post-war economic miracle (and has been also playing a major role on many model railway layouts).

The honour of being the first ones to produce scale 1:220 VW Transporter models belongs to the former Swiss limited-edition manufacturer MZZ and Noch based in Wangen, Germany. Early on, both companies began providing modellers with very different varieties of VW Busses from two different generations. Over the years, other manufacturers followed suit, making it almost impossible to come up with a complete inventory of Z scale VW Transporters having been produced in the past or still in production today.

Due to the fact that car models in our scale tend to be much less catalogued and documented than rolling stock, we will structure our account of Z scale VW Transporters according to prototype generations instead of when a model was first released.

Since many model railroaders still focus on modelling Era III layouts (i.e. 1949 – 1970), it is not surprising that the first generation of the transporter is the one receiving the most attention from model producers and customers. There is probably no body type which has not been available at one time or another.



MZZ was the first manufacturer to produce a Z scale version of a Volkswagen Transporter. It was a panel van version of a VW T2a, and came as part of the package with the article number 3102 (left). Märklin, on the other hand, has two body styles of the VW T1 in its inventory of model moulds (centre and right).

Märklin has long had a T1 panel van version amongst its stock of metal casting moulds and has been using it many times as an accessory to its limited museum editions or its regular production runs of rolling stock. For example, a pickup version with tarpaulin was part of the “Sylt” auto transport train pack (81428).



An unpainted panel van from Märklin (left) displaying its fine engravings such as the VW emblem or the hinged double cargo doors. For comparison, two models with different body styles - “pickup (with tarpaulin)” and “high roof” from MWB’s VW T1 range.

It is worth to note here that the motorized rail car Klv 20 (model year 1955) announced by Märklin in Spring 2019, is based on the first VW Bus generation. An unmotorized version of this vehicle (based on a MWB model) was also available from Rail exclusive (Detlev Stahl, Art. No. BS-017).

During its many years of manufacturing, the first Transporter generation went through some external design changes that are not all immediately recognizable on the models: The first prototype vehicles did not have a rear bumper yet, but no 1:220 models of these types seem to exist.

The mechanical turn signals of the early models were replaced by turn lights due to changes in regulation and placed above the headlights. The roof was pulled over the front windows in 1955. Subsequently, the vehicles were also fitted with larger and oval tail lights. In August 1963, a wider tailgate with a larger rear window followed – all bringing the 1964 T1 model optically close to its successor.

Wolfgang Baumann (MWB) from Wesel probably produced the largest range of models of the first generation VW Transporter. Known models include a fir-green police van, a large-capacity box van (with high roof) and pickup varieties (including double cab) without and with tarpaulin. The models were mostly available in a fully painted “Exclusive” version and an unpainted basic version.



Wolfgang Baumann was the producer of the largest variety of Z scale T1 models. Here a selection of seven different body styles (from left to right): two door regular cab pickup, pickup with extended flatbed, double cab pickup, police van, pickup with warning light, covered pickup and high roof version.



The US manufacturer ZThek also repeatedly had car models in its range, amongst them a panel van version with two side windows in the front area of the cargo bay. The model we are aware of came in fire brigade livery.

What we could not find out is if this particular model was based on a real life prototype or a product of the manufacturer’s imagination. During that period there were many body shops which adapted standard vehicles to their customer’s needs, some close to the original body shapes and others completely remodelled.



**Top left:**  
This unfortunately very small picture shows the fire brigade panel van variant from ZtheK with two side windows in the area of the cargo bay and pump trailer from Memotec. Photo: ZettZeit, Jens Wimmel

**Bottom left:**  
The hinged side doors and the double-colour paint scheme suggest that this Limited model is supposed to resemble a VW T1, but its rather boxy and flat shape do not really correspond to the shape of the prototype.



Limized also came out with its own interpretation of a T1. Unfortunately, this two-coloured minibus appeared to be very boxy and lacked the typical curved front section. A special model is a pickup version presented by NoBa models at a railway modellers meeting in Sindelfingen. It is a scale 1:200 model, but allows for the installation of a motorised chassis for the Z-Car system.

The current Trafofuchs “Volkswagen Transporter” model (KL01), on the other hand, is a fine rendition of the prototype version. It clearly and without doubt represents a variety from the T1a series. What we could not establish during our research into the history of VW Transporter Z scale models was if there ever has been a model of the double cab version produced from 1959.

## Rhythm in the blood

One of the most popular VW bus types ever was the “Samba“, or officially the “VW Bus Special Edition”. The most recent Z scale versions of the Samba are from Zcustomizer and from Raffaele Picollo, Genoa (Italy). Both models come with transparent windows, quite a unique feature amongst Z scale car models.



The Samba buses without rear curved windows from Zcustomizer (picture left) and Raffaele Picollo (picture right) are among the most recent additions to the portfolio of VW buses in scale 1:220. Both have opted for the most common prototypical paint schemes. Raffaele Picollo’s model comes also with decorative chrome strips, exterior rear view mirrors and illuminated headlights. Photo right: Raffaele Picollo

Most other 3D-printed or resin cast models are solid and therefore have painted windows. Before we continue with our report on other models, let us briefly provide some information about the prototype of the Samba.

The Samba bus was first released in 1951 and offered a number of comfortable extras and a larger number of windows for a better view, compared to the standard bus. Each side had four panoramic windows on edge of the roof as well as curved windows at the rear end. Both window types had plastic panes. This type was reproduced in the MWB range of VW bus models.

From August 1963, the rear corner windows finally gave way to a modified tailgate with a larger rear window. This design is generally less well known, probably due to the smaller number of models produced.

In the sixties and seventies, and even more than the Beetle, the Samba bus became a symbol of the hippie movement. But also many ordinary T1 and T2 vans were converted into richly coloured campers and served to travel the “Hippie Trails”, meaning east and south in Europe and direction West Coast in the United States.

Volkswagen was actually not pleased with this development. Its marketing managers were concerned about the possible negative impact on sales for their most important vehicles and their hitherto positive public image.

Turning back to the history of Z scale Transporter models, we now arrive at the Dutch 3D printing producer A2 Models, which offered or still offers T1 versions of a minibuss, a panel van, a pickup with a loaded ladder and a Samba bus in green, grey and yellow.



The hippies' desire to travel is also a frequent scenic theme for model railways, especially as the hippie times corresponds to the popular Era III model railway period. Raffaele Picollo gave two of his buses a hippie design (top left and right). Rolf's Laedchen also sold two different designs: a natural green VW T2b version based on a model from MWB (bottom left), here with matching figures from Trafofuchs, and a repainted Samba bus from A2 Models (bottom right). Photos top left and right: Raffaele Picollo

Although marked as a 1950 model year, these are more recent versions of the prototype. This is particularly evident in the "Special Bus" with its panoramic windows. This Samba bus has the correct number of windows, but the rear corner windows are already missing. It therefore corresponds clearly to the model years starting from 1963 (1964 model).

As shown on their website, all A2-Models interpretations of the Samba come with a roof that protrudes over the windshield and with turn signals over the headlights. Z scale accessories specialist "Rolf's Laedchen" has also jumped on the Hippie bandwagon.

Based on a MWB-model it offered T1 panel vans under the name “VW Bully sunny yellow” (10300.Z) and “natural green” (10301.Z). Although probably not suitable for travelling the colours of these vans were rather nice. Our images show the natural green version using the example of the successor T2.

For those wanting to their own paint job: give it a try, painting is not that difficult. Suitable inspiration is easily found on the internet. As soon as you have decided on a model, all you need is a steady hand, a particularly fine hairbrush and some paint. We based our own Hippie-Sambabus on a model from A2-Models.



A Samba bus, officially simply called “VW Bus Special Edition”, from A2 Models (left) meets a specimen of its successor generation, a VW T2b police version from of MWB (right).

## A car grows up

Compared to its predecessor, the second generation VW buses were much more mature. Their Z scale incarnations are also among the most attractive, but also the most demanding models to work with, mainly due to the challenges of achieving a faithful rendition of its slightly curved front section.



VW transporters in the livery of the West German postal service: They were once a very regular sight on German roads and no period specific railway layout would be complete without at least one of these vehicles. In particular the high roof version of the T2b (far right) will still be remembered by many modellers. All four models shown here are based on MWB Basic models.

By the way, MZZ produced the oldest buses of this VW generation. They were initially sold as a package package together with either a Ford Transit (3101) or a Unimog (3102), in the first case as a pickup with tarpaulin, in the second as a panel van. Later, they were also sold individually at trade fairs without having been assigned a new article number.

Limized also came out with a T2a version of a body type different from what MZZ had in its range. As was already the case with the Limized T1 model, some of their T2 models also had front sections which were too flat compared to the original.

This case illustrates quite clearly that a fully precise downscaling does not always produce a successful and good looking model. Sometimes, it is better to under- or overemphasize certain characteristic features in a model in order to achieve a credible and prototypical rendition.

To some extent this issue also affected the “VW Camping-Bus” in silver (10330.Z) and blue metallic (10330a.Z) taken from the stock of the “Ideen-Magazin” and redistributed by Rolfs Laedchen.

These models also represent the earliest T2 body type, with turn signals placed at the bottom, a bumper which still was bent around the corners and steps for entering the driver's compartment.



As with the T1 models, Modellbau Wolfgang Baumann (MWB) was also the most prolific producer of second generation VW Bus Z scale models. All models shown here are T2b varieties: Panel van and transporter versions at the top and below a municipal utilities version, a Westfalia camper and a police version.

It was again Wolfgang Baumann (MWB) who produced the largest range of T2 models. For example, his panel van was temporarily available in the earliest design version as well as in the later version with shorter bumpers and indicators located at the top. The younger design was also available in a high roof version, once a typical feature of the fleet of buses of the West German postal service.



Encounter at Westerende station between a rail car and holidaymakers in a Westfalia camper bus (MWB model) on their way to the East Frisian coast. Soon they will have reached their destination and be able to cool down by taking a swim in the North Sea.

Police and fire brigade versions with signal lights on the roof were also available, together with versions painted in orange livery of municipal utility vehicles.

A unique model was the Westfalia camper van with its rather eye-catching design including a front mounted covered spare wheel. All these models were always available in basic (unpainted) and "Exclusive" (fully painted) versions.

### Last generation with a rear engine

Compared to the T1 and T2 generations, the choice of available models of the T3 has been much more limited. Actually, we are aware of only two manufacturers who have come up with Z scale versions of the T3.

One is the model railway accessories manufacturer Noch which produced versions with transparent windows.

**Right:**  
A rental car in front of the cemetery? Let's hope it's just a relative of a deceased laying flowers on the grave.





Noch produced several Z scale versions of the boxy Volkswagen T3. All of these, with the possible exception of the model to the far left, would not meet today's quality expectations.

The paintwork on the NOCH was rather crude by today's standards - sometimes quite thick and mostly too glossy – and rather poor imitation of lights.

The models came as VW transporters in a double pack (4732), in neutral yellow for possible labelling as postal service vehicles (4771) and as part of a two-part rental car collection "Interrent" (4772).

An optically more satisfying model of the T3 was produced by Limited. They made a high roof ambulance version, which had four signal lights. They also made a THW emergency vehicle with double cab, but that was a model of a VW LT 45 - the larger brother of the VW Transporter.



This version of a high roof T3 ambulance counts definitely amongst the better Z scale implementations of a VW bus. Unfortunately, this model is no longer available today.

## Arriving in the present times

With the T4 generation, we are now entering the more recent past as well as present times. Whilst the older VW Transporter generations already fall into the classic car category, the T4 is still very much present on our streets.

The T4 was the first VW Bus which came with the option for different wheelbases, a feature which was taken up by MWB when designing its Z scale versions of the T4. The MWB product range also included various body types from the Minibus and Transporter



varieties. Some of the panel vans also had different roof heights and were available with either a tailgate or laterally hinged doors.



Different MWB models of the T4 generation with different rear doors and flaps as well as different wheelbases. The much more recent 3D print model from Zcustomizer now even has aluminium alloys and exterior mirrors (page 30 bottom right; photo: Zcustomizer, Sascha Braun).

Currently, Zcustomizer offers a panel van with well-designed aluminium rims. To the best of our knowledge, there are no further suppliers of scale 1:220 models of the T4 (1990 and 2003).

The situation is better with the current T5 and T6 generation, which are optically and technically very close and hardly distinguishable from each other at a scale of 1:220. NoBa-Modelle is one manufacturer and is run by a couple from southern Germany who are 3D-printing enthusiasts and who have produced models of the T5 as a Multivan (6207 / 6207R / 6208 / 6209R), pickup (6203 A / 6205) and camper motorhome (6204) with a roof box.

According to their catalogue, there is also an ambulance version available (6201), which does seem to be, however, a different Volkswagen Type (KTV).



VW T5 busses from NoBa-Modelle, available as ambulances (left) and multivans (right). Photos: NoBa-Modelle

For a layman, both may (seemingly) be identical, but emergency rescue vehicles typically have a larger and heavier equipment and the patient must be accessible from three sides. The VW Transporter is actually too small for these purposes and does not have the sufficient payload.

But some degree of artistic freedom and creativity is fine and enriches the hobby. Trafofuchs, for example, offers a camper mobile (KL20) with an angled folding roof which looks very similar to a Volkswagen T6.

Top-class model cars have been coming from Portugal for some years now. Álvaro Cortes produces with great passion and skills highly detailed models with many intricate features. New this year are replicas of the T5 and T6 as emergency vehicles for Germany, Austria and Switzerland (police and emergency doctor).



Álvaro Cortes launched a variety of T5 and T6 models only this year. Here several T6 varieties with individually designed wheels. Photo: Álvaro Cortes.



Currently, only few Z scale models of the VW bus are commercially available (here a T4 panel van from MWB). This raises the question about their future availability to modelling enthusiasts.



He also offers the VW T6 in different civilian versions (metallic paintwork and black), including a yellow version as a delivery van with a windowless cargo bay. Also available is a van version with a window in the sliding door and a panel van with a long wheelbase.



Remembering the good old and mostly quiet times with a VW T1 panel bus parked outside the signal maintenance shop.

Summing up, we have learned that there have been Z scale models for all generations of the VW Transporter. But the picture is heterogeneous and some types and generations have been better represented than others. Some models have not stood the test of time, and some manufacturers are not active anymore. We therefore conclude that "There is still a lot to do".

**Pages of still active providers:**

- <https://www.maerklin.de>
- <https://www.noba-modelle.de>
- <http://www.rolfs-laedchen.de>
- <http://www.trafofuchs.de>
- <https://www.zcustomizer.de>

Journeyman's piece for a masterpiece

## On the North Sea coast...

*...on the Platt (low) German beach. A diorama invites you to implement the finest details, which can only rarely be realized in such a way on facilities. They also offer an excellent surface for finger exercises and the rehearsal of new techniques. Dietmar Allekotte used the EM diorama competition to prepare an even larger work.*

When our editor Dirk Kuhlmann pointed out a diorama competition of the railway magazine in the forum of the Z-Freunde International and we also called for participation in this magazine, Dietmar Allekotte from Mülheim (Ruhr) immediately knew that he wanted to participate.

For him it was a matter of trying out new techniques and creating a sample piece for his project "Marienfeld", which was to be tackled as a peep-box system. Where else can you try out, sharpen or rehearse your skills and working methods?



Dietmar Allekotte's diorama "Küstenland" shows a stretch of beach whose access is cut off by the railway line. Swimmers access the sandy beach via a pedestrian bridge.

Thanks to the North Sea motifs for "Marienfeld", the theme for the diorama Dietmar wanted to submit to the competition was also set: a stretch of coast with a beach. In contrast to the landscape shown, the title was simply "coastal land".

There was also no consideration to the basic dimensions of the showpiece, because these were binding on the part of the competition conditions. So the viewer had to be content with a base area of 15 x 30 cm - small for larger scales, but for Z gauge it was an area on which to let off steam.



The V 36 was still quite common in northern Germany at the beginning of the 1960's, and was always used in local transport before conversion cars, when the capacity of a rail bus was not sufficient during busy periods.

## The start of construction

Now we had to come up with a plan before we could get started! After a short consultation with Dirk Kuhlmann he was determined and it went fast. Now our reader could prepare everything for the construction in no time at all.



Cork plate parts, Faller Styrofoam walls and a piece of woodchip wallpaper form the essential foundations of the later landscape. Photo: Dietmar Allekotte

Even in the run-up to the event, he had intensively discussed the works and working methods of his mastermind and idealistic pioneer Dirk Kuhlmann.

Dietmar tried not only to see the designed surfaces, but also to question and understand their emergence.

If such powers of observation are combined with one's own handwork, then this offers the best basis for outstanding results. And this has certainly been achieved in this case, as the accompanying photos also show.

However, the first to be sought now was a suitable board as a base. As chance would have it, Boesner found another painting base in exactly the right size. So we could start right away. He roughly drew the ground plans onto the board with a pencil and divided it into sections.

Dietmar wanted to proceed exactly according to the method he had read and meticulously followed in **Trainini®** construction reports. So he first laid out a piece of cork and in the area of the later water a piece of woodchip wallpaper.

This was followed by a test of the plan with the track, which was bordered by a strip of Styrofoam wall (Faller) once it was cut to size. Dietmar Allekotte thought this was the way it should work, and set out to give the landscape permanent structures.

As soon as everything was glued into place, he roughly preformed the terrain and covered it with the Molto-Reparaturspachtel (Repair Filler), which seems to have become a new model building standard material. The client spent the necessary dry season combing his sources in search of a suitable bridge. After all, there was a need for a safe crossing possibility for bathers seeking beach access.

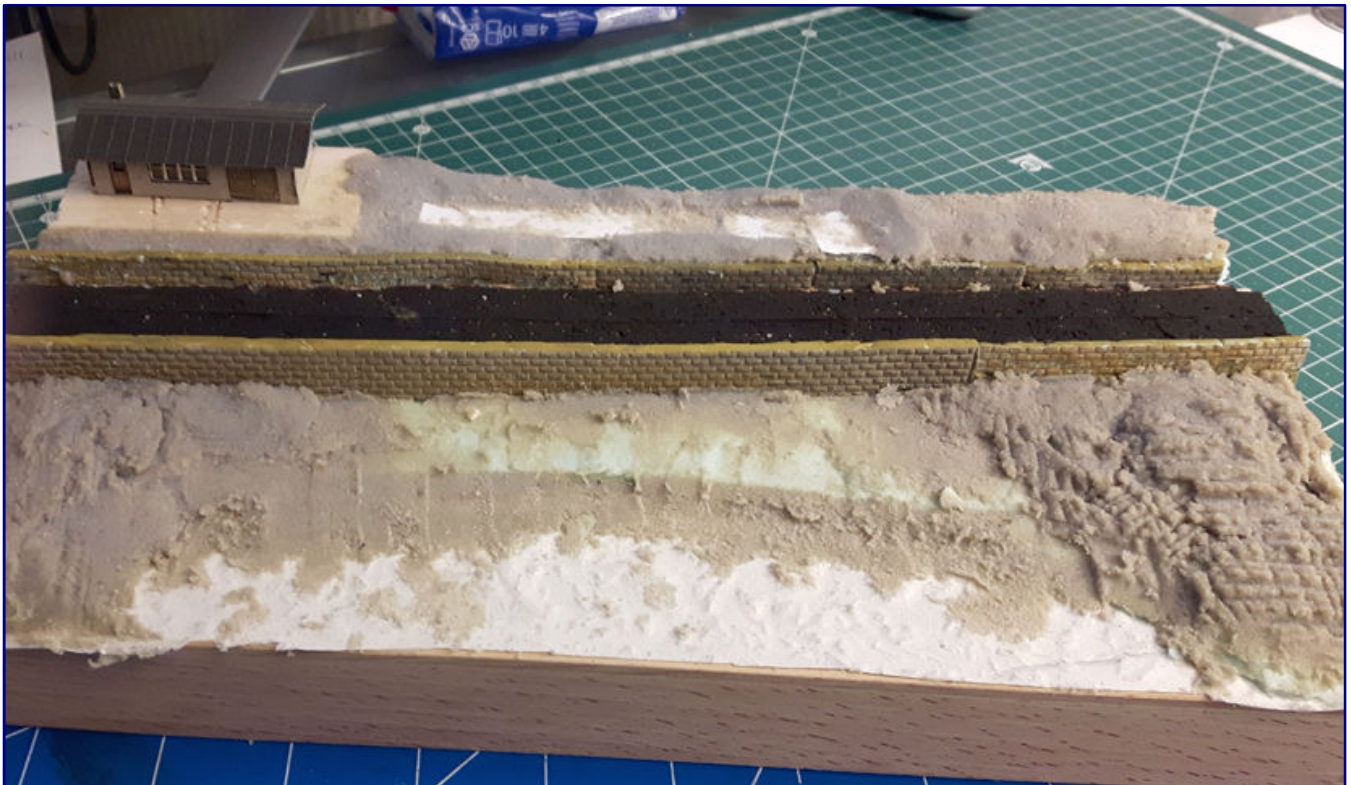

After the rough landscaping, a coat of Molto Reparaturspachtel (Repair Filler) was applied, whose sandy structure was well suited to the theme of this diorama. Photo: Dietmar Allekotte

Didn't he have something from his friend Peter Rogel somewhere? But it didn't help. His find was too rough for the intended purpose and didn't really fit the motif. His ambition and his expectations, which had risen in the meantime, required more filigree parts.

And so he finally ended up with HOS-Modellbahntechnik, one of the recognized specialists, when it has to work really well and be especially fine. A short phone call and a few photos later, Heinz O. Schramm set to work and designed exactly the bridge that was on our reader's wish list.



For the pedestrian bridge, which some recreation seekers have now discovered for flying kites, Dietmar Allekotte finally resorted to a custom-made HOS model railway technology.

As a kit for the small locksmith's shop behind the railway line, however, he used a hut from MBZ, which was already in the kit. Once the first colours of the terrain had been applied, the necessary positioning tests could take place to bring the plan into line with the actual effect.

It all took shape, but somehow the designer didn't like it yet. Without further ado, the seawater area was extended to the outer edges. Another point was the number of details to be found here so that it would not be boring for the viewer. After all, the viewer has to be captured and captivated when panning over many dioramas in order to motivate the fair visitors to vote.



The first sand and paint were applied, then a one armed signal followed, mounted on a pedestal. Photo: Dietmar Allekotte

So Dietmar came up with the idea to position a one armed signal near the centre, for which even a defective model would be sufficient. After all, its electrical function was not required. Remnants that could be used to build a base were also found in the bargain bin. Another feature with a function questionable to the viewer was the drain pipe near the beach: what is discharged here near the bathers in the sea?



At general view, also drain-pipe (far left of picture) near beach is to see: What is discharged into the sea there?

## Construction progresses

In the meantime, the terrain structure had been completed to such an extent that the first green bushes and trees and the sandy beach could already be added. After everything was in the right colour and the tracks were painted in the proper rust colour, which was indispensable for a credible effect, it was time to design the water.

Also here our attentive reader worked exactly according to the procedure described by Dirk Kuhlmann, which goes back to the former design expert Rolf Knipper. After the application of the paint for the sloping bank, which had been washed over by the tides, two layers of high gloss boat paint followed.

In the meantime, the bridge had already been delivered and required to be installed at the intended location on the right edge of the diorama. Meanwhile, the landscaping progressed with grass from Noch, which had been applied with a Grasmaster.

Thus the diorama "Küstenland" was already largely finished, but suitable figures were still missing. After all, it is these figures that make life noticeable. The order went to Trafofuchs and was solved by Birgit Foken-Brock to the full satisfaction of the contestant.

And so Dietmar Allekotte draws a satisfied conclusion despite missing an overall victory. We let him speak again personally: "This diorama was exactly the right project for me to test important things for my next plant "Marienfeld". For me, the construction reports in the **Trainini®** were like a gift. I remembered and tried a lot for myself."

## Display



**14. Modellbahn-Ausstellung  
Zeller Adventsmarkt**

**Zell an der Mosel  
Zeller-Schwarze-Katz-Halle**

**Sonntag, 08. Dezember 2019, von 11 bis 17 Uhr  
Veranstalter: Z-Freunde International e.V., 56856 Zell (Mosel)**

**ACHTUNG!**  
Zeller Altstadt gesperrt -  
Anfahrt nur über Bulley möglich!

**ACHTUNG!**

Well then, for us it is also a gift to be able to share the creation and the finished diorama including experiences with all our readers.

Feel invited to share your ideas and work with us at any time. Tens of thousands of people all over the world are looking forward to working with you!

Motivation was provided by the following websites:

<https://eisenbahnmagazin.de>  
<http://helenensiel.com>

Websites of the suppliers mentioned in the text:

<http://www.hos-modellbahntechnik.de>  
<https://www.mbz-modellbahnzubehoer.de>  
<https://www.noch.de>  
<http://www.trafofuchs.de>



The small locksmith's shop behind the railway line comes from an MBZ kit. Embedded in the landscape, it is surrounded by lush greenery.

Note for English readers: The literature section that follows is not translated into English because the original texts of the books involved are in the German language. The original German is left here for information purposes only.

## Der VW Transporter im Wandel der Zeit **Auto-Legende – legendäres Auto**

*Wenn ein Auto Geschichten und Geschichte schreibt, dann muss es etwas ganz Besonderes sein. Freunde des „Bullis“ werden dagegen nicht ihr Wort erheben, denn für sie ist der Transporter genau das. Mit ihm verbinden wir noch heute Wirtschaftswunder, Blumenkinder, Vereinsfahrten und Kegelausflüge, aber er war (und ist) so viel mehr. Wenn ein Auto zum Alltag gehört, dann kommen wir auch als Modellbahner nicht an ihm vorbei, dachten wir, und lasen dieses Buch.*

Alexander F. Storz  
Die Bulli-Legende  
Als Bullis noch Samba tanzten

Motorbuch Verlag  
Stuttgart 2016

Gebundenes Buch  
Format 23,0 x 26,5 cm  
192 Seiten mit 122 S/W- & 186 Farbbildern

ISBN 978-3-613-03883-7  
Titel-Nr. 03883  
Preis 24,90 EUR (Deutschland)

Erhältlich direkt ab Verlag  
oder im Fach- und Buchhandel

Der Autor des hier besprochenen Buches, Alexander Franc Storz, arbeitet als Journalist im Bereich der Automobilhistorie und ist für verschiedene Fachmagazine tätig. Die Liste der von ihm veröffentlichten Bücher erscheint fast endlos lang. Viele berühmte Automodelle waren darunter, hier ist es nun mit dem Transporter von Volkswagen ein weiterer Klassiker.



Mittlerweile erscheint dieser gemäß der Zählweise von VW schon in der sechsten Generation. Seine Liebhaber, die der Wolfsburger Konzern schon mit einem Microbus in Retrogestaltung zu einem Umsatz verleiten wollte, nennen ihn bis heute liebevoll Bulli. Das gilt freilich nur für den deutschen Sprachraum, wie wir in unserem vorausgegangenen Artikel erläutert haben.

50 Jahre Zeitgeschichte sind über den „Typ 2“, dessen Produktion wegen seines schnellen und großen Erfolgs rasch vom Stamm- ins neue Werk Hannover verlegt werden musste, gegangen. Geblieben ist sein Ruhm: In den Fünfigern symbolisierte er neben dem Käfer das Wirtschaftswunder, in den Sechzigern zeigte er dann eine wahre Modellvielfalt.

Die Siebziger erlebte er als Lieblingsgefährte der „Blumenkinder“, die sich für Liebe und Frieden aufopferten und dabei gern dem Drogenkonsum hingaben, in den Achtzigern schien er dann erwachsen geworden zu sein. Bis heute ist er ein akzeptierter und beliebter Transporter geblieben.



Der Autor nimmt seine Leser mit auf diese erlebnisreiche Zeitreise durch immerhin vier Jahrzehnte. Er erzählt vom Ursprung und der Idee zum Erfolgsmodell, das von einem niederländischen VW-Importeur vorgeschlagen wurde. Mit „Geschichte und Geschichten“ lässt es sich wohl am besten umschreiben, was Alexander Storz da im größten Kapitel des Buches ausbreitet.

Bis einschließlich zur Seite 121 des 192-seitigen Bands befasst er sich nur mit der ersten Generation des Bullis, der offiziell nie so heißen durfte. Er lässt den Leser erleben, wie dieser Klassiker auch modernere Konzepte von Konkurrenten wie Gutbrod, Goliath, DKW oder Ford abhängt und neben dem „Typ 1“ zum Symbol des deutschen Wirtschaftswunders wird.

Unterstützt wird all das von hervorragenden, zeitgenössischen Fotos, die anders als Werks- und Werbeaufnahmen den Alltag der Deutschen jener Zeit zeigen. Und da gehörte der VW-Kleinbus immer dazu: Sei es im Kundendienst, beim gewöhnlichen Handwerker, als Lieferwagen, Sambabus für Kleingruppenreisen, Lotsenfahrzeug auf dem Flughafen, bei Polizei, Post oder Bundeswehr, dieses Auto gehörte immer dazu.

Natürlich kommt auch dieser Band nicht ohne die genannten Werks- und Werbeaufnahmen aus, aber hier bringen sie vergleichend zum Ausdruck, wo und wie Anspruch und Wirklichkeit auseinanderlagen. Privataufnahmen zeigen das wahre Leben, das so nur deutlicher wirken kann.

Jahrzehntelange Normalität und deutscher Alltag sind es, die authentische Anregungen für die heimische Modellbahnanlage liefern und es ermöglichen, in den Geist jener Zeit einzutauchen, ohne sie als zu schön zu verklären.

Wer guten Modellbau wünscht und umsetzen möchte, der kommt an zeitgenössischen und unverfälschten Eindrücken nicht vorbei. Und so hat auch uns ein Buch beflügelt, an das wir uns sicher noch lange erinnern werden, weil es stets gute Dienste leisten kann.

Schön ist, dass es sich nicht am Transporter erster Generation erschöpft. Bis zum letzten Hecktriebler in Form des T3 reicht es und wirft dann kurz einen Blick in die Zukunft, die wir nach dem Ende der Lektüre auch längst schon wieder als Vergangenheit erkennen müssen.

Selbst das Ende vieler Fahrzeuge wird in Einzelschicksalen gezeigt, sei es auf dem Schrottplatz, nach Unfällen oder gar als Schafstall. Auch das ist wahres Leben. Kein Hehl wird auch daraus gemacht, dass die Begeisterung auf den Exportmärkten Ende der siebziger Jahre wegen des überholten Antriebskonzepts abebbte.

Volkswagen hielt dennoch auch in dritter Generation daran fest und wusste zumindest im heimischen Markt noch lange damit zu begeistern. Aber das macht Legenden aus: Sie sterben nicht, sie verblassen höchstens.

So lautet immerhin das Schlussfazit des Autors, dem wir uns gerne anschließen. Es spielt eben keine Rolle, ob wir den „Bulli“ mögen oder nicht. Wir sind alle in ihm oder mit ihm gefahren, haben Erinnerungen an ihn und kommen auch im Hobby nicht an ihm vorbei.

Deshalb lohnt es sich auch, ihn zu würdigen und sich mit ihm zu beschäftigen. Wer seine Anlagenbetrachter einfangen und fesseln möchte, der muss schließlich auch ihre Erinnerungen wecken und ihnen Bilder in den Kopf setzen.

Womit ginge das besser als mit diesem Auto, das (bis zum zeitlichen Schnitt im Buch) vierzig Jahre Geschichte begleitet und geprägt hat. Und wo wird das besser aufbereitet und dokumentiert als in diesem Buch? Wohl nirgendwo, denn es ist kein klassischer Technikband, der nur Puristen und Sachverständige begeistert, sondern ein lebendiges Fotoalbum.

.....  
Publishing pages with reference possibility:  
<https://www.motorbuch.de>  
.....

## Fahre lieber mit der Bundesbahn Jugend auf großer Reise

**Was tun, wenn man Ende der Sechziger gerade in der Ausbildung ist, kein eigenes Auto besitzt und die Bundesbahn werbewirksam das Ende der Dampflok ankündigt? Da bleibt doch nur eines: Tasche packen, Urlaub nehmen, Route zu den letzten Fotostätten planen, Fahrkarten kaufen und mit der Bahn auf große Reise gehen. Genau das haben die beiden Autoren des an dieser Stelle besprochenen Buches getan. Und ihr Druckwerk ist nun so einmalig wie ihre wohl größte Reise.**

Rainer Schnell / Helmut Philipp  
Bundesbahn-Tour '68  
Als die DB ihren Loks das Rauchen abgewöhnte

VGB Verlagsgruppe Bahn GmbH / Klartext Verlagsgesellschaft  
Fürstenfeldbruck / Essen 2018

Gebundenes Buch  
Format 22,3 x 29,7 cm  
192 Seiten mit über 260 S/W- und Farbbildern

ISBN 978-3-8375-1996-9  
Best.-Nr. 581803  
Preis 29,95 EUR (Deutschland)

Erhältlich direkt ab Verlag  
oder im Fach- und Buchhandel

„Wenn jemand eine Reise tut, dann kann er was erzählen!“, weiß der Volksmund. Was in diesem Sprichwort an Wahrheit steckt, wissen die Autoren Rainer Schnell (Jahrgang 1949) und Helmut Philipp (Jahrgang 1948) zu berichten.

Gemeinsam mit ihrem bereits verstorbenen Freund Ulf Schleef haben sie im Juli 1968 eine elftägige Fotoreise per Bahn unternommen, um den letzten Dampftrössern in ihren noch verbliebenen Hochburgen aufzuspüren und sie auf Zelluloid zu bannen und für die Nachwelt zu bewahren.

Akribisch und mit Leidenschaft bis ins kleinste Detail geplant, wollten sie möglichst alle noch im Dienst befindlichen Baureihen – mit Ausnahme der noch an ihrem Heimatort Hamburg alltäglichen Maschinen – auf den Bahnhöfen und in den Betriebswerken dokumentieren.

Dass eine solche Reise quer durch die damalige Bundesrepublik angesichts der langen Reisewege und vielen Unterwegshalte bei gleichzeitig eher kurzer Reisedauer mehr eine Hatz als ein Erholungsurlaub ist, wird sich jeder wohl problemlos vorstellen zu können.

Glücklicherweise ist das den mitgebrachten und bewahrten Aufnahmen nicht anzusehen. Alle sind sie handwerklich korrekt, schön hinsichtlich Perspektive, Umfeld und Motiv sowie obendrein auch hervorragend im Druck umgesetzt worden.

Vielen ist durch die Körnung - den Farbbildern bisweilen auch durch das den Filmen typische Farbspektrum - das Alter von inzwischen fünfzig Jahren anzusehen. Aber das ist hier kein Mangel, sondern ein hervorragender Beleg für die Authentizität solch historischer Dokumente. Wäre dies nicht der Fall, würde der Leser bei der Lektüre glatt Raum und Zeit vergessen.



So packend ist das Buch, wenn es erst einmal in die Hand genommen wurde. Die Autoren berichten voller Enthusiasmus von ihren Begegnungen mit technischen Dinosauriern, der Willkommenskultur in den damaligen Betriebswerken, sintflutartigem Dauerregen, einer wegen Nachtruhe verschlossenen Jugendherberge und einem Dienststellenleiter, der überhaupt nicht in die ansonsten so gut gelungene Reise passen wollte.

Die drei Berufsanfänger hatten nichts dem Zufall überlassen wollen und sich in allen Beheimatungsorten der Lokomotiven zuvor schriftlich angemeldet. Meist erhielten sie nicht nur einladende Antworten, sondern auch Aufstellungen der Fahrzeuge, die sie dort erwarten durften.

Dass sie auch den Maschinen des BZA Minden sowie dem AW Schwerte (Ruhr) einen Besuch abstatten wollten, erwies sich als Glücksfall, denn besonders im Ausbesserungswerk stießen sie auf eine leider nicht erhalten gebliebene Sammlung längst ausgemusterter Relikte, darunter die Baureihen 17 und 62.

Und in Minden erfuhren sie wenigstens noch, dass sie 45 010 nicht abschreiben mussten, weil sie nicht ausgemustert, sondern zusammen mit ihrer letzten Schwesterlok kurz zuvor nach Mühlendorf umbeheimatet worden war. Eben das führte dann noch zu einer kurzfristigen Planänderung. Wo der Regen in die Quere kam (Köln), konnte der Bildbestand immerhin später noch bei einem zweiten und dritten Besuch aufgefüllt werden.

Doch was macht dieses Buch so besonders und hebt es von den vielen ähnlichen Werken über diese Zeit ab? Zum einen ist es die Zeit der Revolution, denn die dem nach dem Reisejahr benannte Bewegung, sorgte gerade für besondere Unruhe und Nervosität in den Amtsstuben und Polizeidienststellen. Eine Revolution in verkehrlicher Hinsicht stellte auch das dar, was sich parallel auf den Schienen abspielte.

Während die Bundesbahn ihren Lokomotiven gerade werbewirksam „das Rauchen abgewöhnte“, kamen die Elektrifizierungsarbeiten langsam zu ihrem Ende und die V-160-Familie setzte mit Versuchslokomotiven zur elektrischen Zugheizung zum anstehenden Höhenflug an. Zugleich war es das Jahr der Umnummerierung: Alte Baureihenbezeichnungen und Computernummern waren für kurze Zeit nebeneinander zu sehen und zu erleben.

Das Glück des Lesers ist, dass die drei jungen Fotografen all das in großer Voraussicht miteingefangen haben. So richteten sie ihre Kameras nicht nur auf die geliebten Dampflokomotiven, die schon bald verschwinden sollten. Vielmehr dokumentierten sie alt neben neu und opferten ihr teures Filmmaterial auch für Stangenlokomotiven der elektrischen Generation, Prototypen der E 10<sup>0</sup>, Dieseltriebwagen, Einzelgängerinnen und Raritäten oder sogar der hochmodernen E 03. Auch die V 36 ist mehrfach dabei.

An elf Tagen im Juli 1968 haben sie auf 3.000 Kilometern Reisestrecke ein fast repräsentatives Bild dessen eingefangen, was die Bundesbahn ihren Kunden in einer Zeit des Umbruchs anbot. Dagegen erscheinen andere Bücher leider häufig wie Zerr- oder Wunschbilder.

Insofern fasst der Rezensent seine Eindrücke und unsere Begeisterung wie folgt zusammen: Einmal zu lesen begonnen, mag ich dieses Buch nicht mehr aus der Hand legen! Die vorliegende Bilddokumentation lässt die Hektik der Reise glatt vergessen. Kurze Erläuterungen zu ausgewählten Themen oder Baureihen krönen das gelungene Werk.

Vielseitig wird das Buch durch die vielen Gegensätze zwischen moderner und Dampftraktion, alten und Computernummern, aktiven Maschinen und solchen auf dem Denkmalssockel. Und genau das hebt es auch von vielen anderen Veröffentlichungen zu vergleichbaren Themen ab und macht den Unterschied!

Publishing pages with reference possibility:  
<https://shop.vgbahn.info/vgbahn>

The Herpa Summer Festival 2019

## The sun smiles for the anniversary

*The 20<sup>th</sup> summer festival of Herpa was under a good star, because the weather could not have been better. And so a record number of visitors arrived to literally hike through an equally record-breaking exhibition. There was also a lot on offer for children, making it an event for the whole family. And, of course, Trainini® was also there.*

Every year the accessories manufacturer Herpa invites you to its summer party in Diethofen. On a Saturday at the beginning of July, the small community in the Ansbach district near Nuremberg then becomes a pilgrimage site for friends of model cars, small aircraft and above all large trucks in a special design.



The calm before the great storm: In Diethofen, preparations are being made and set up at the Herpa headquarters for the 20th summer festival. The next day, 11,000 visitors celebrated Herpa's 70th anniversary here in the best weather possible.

This year the festival took place on 6 July and had a special occasion: it was the 20th edition and the Herpa brand celebrates its 70th anniversary in 2019. So the open house was allowed to be much larger than usual.

An organiser must always be concerned about the weather at meetings of this kind, which take place predominantly outdoors. But that also played along and the sun laughed all day long about Diethofen. It was almost too hot to stay outside for a long time.

But that didn't scare the guests: Herpa was able to welcome around 11,000 visitors, almost twice as many as at many a previous summer open houses. And a colourful and exciting programme awaited the guests.

This ranged from manufacturer presentations, musical performances on a stage, painting demonstrations with an airbrush, to culinary delights for the well-deserved breaks.

The cake buffet with a large selection was once again donated by company employees. The proceeds from the sale are traditionally donated to charitable causes.

An integral part of the summer festival is always the Herpa Museum, in which the company's history is presented and where long-term cross sections of the programme are shown.

Those who went through the individual rooms here attentively, and then also took part in a production tour were able to answer most of the questions in the competition.



That's what winners look like! Three winners of the Herpa Rally were each presented with a shopping voucher for 100.00 Euro.



Painting demonstrations were also part of the event programme. Decorative clothing with colourful motifs could also be purchased afterwards.

At this summer festival rally there were three vouchers for 100 Euro to be won, which could be redeemed at the museum's factory outlet. In addition to products from the current program, there were also rare pieces to buy: On a rummage table, samples of earlier models, which Herpa wanted to part with, were again waiting for buyers.

With a single SE-210 Caravelle in LTU paint, it included a 1:200 scale aircraft model from 2006, which would certainly be an eye-catcher on any layout or diorama because of its striking colour. For friends of the H0 gauge, a bargain sale at the edge of the Herpa administration building was recommended, which included current as well as older miniatures.



The Sud Aviation SE-210 Caravelle 10B1R from LTU (Art.-No. 551496) is a 1:200 scale Wings model from the first half of 2006 and was one of the rummage table finds in the Herpa Museum at this year's summer party.



Numerically and optically, however, the templates for many Herpa models of the scale 1:87 dominated the summer festival.

The organisers have provided around 100 showcases in elaborate paintwork, ranging from a simple high advertising effect to sprayed-on surface works of art.

They were placed on surfaces of the work and at the roadside. There they occupied several hundred metres to the border of the neighbouring town of Leonrod, where a large meadow area had to be included as well.

**Photo left:**  
Renault trucks are in the minority among viewers. Therefore, the "Green Mamba" stood out even more among the exhibited vehicles.



Photo above:  
The Heide-Logistik from Lower Saxony has a number of show trucks in its fleet and is one of the regular guests at the Herpa summer festival. And so the "Hanse pirates" were just one motif from a very appealing series.

Photo below:  
A well-known Zettie, Torsten Schubert, is responsible for the effective implementation on the basis of Herpa models. This motif is called "Ghost Rider".

There had never been anything like this before in Diethenhofen and was certainly the biggest visitor magnet for the company's 70th anniversary. For children it was all the more attractive as some trucks and the company's own historic VW Beetle also provided them with an opportunity to take a ride along the closed Leonrodstraße.



With the support of Conrad Electronic, Modellbahn-Union, Noch and Uhu, **Trainini®** had set up its first stand at the summer party: Here, children were able to design a beer mat with a small landscape according to their wishes with expert help: The choice included scatter grass, groundcovers, small plants, trees and figures. Those who wanted could also purchase a Herpa miniature car and equip its lid as a street.

If they and their parents had had enough of the big vehicles, they could also admire some of them as miniatures. As in previous years, Torsten Schubert was also present and showed his elaborately illuminated models including some finely designed Z-scale dioramas on which he also used Herpa products.

But the youngest were also awaited by many opportunities to participate and craft tables. They could, for example, assemble houses with Faller and Auhagen kits, assemble a Herpa car or, with **Trainini®** design a beer deckle (mat) with these articles. These proven actions enjoyed again large Zuspruch.

The diorama "Auf der schwäb'schen Eisenbahn" (On the Swabian Railway) from **Trainini®**'s younger generation served as proof that model making is child's play. It should have a motivating effect, challenge the creativity of the children and allow them to create their own designs.

On the other hand, the dioramas shown by other groups with vehicles in H0 size or the airport dioramas presented by Frank Meisen in 1:500 and 1:200 scales, which demonstrated equally great skill, were more aimed at adults. What comes out of it, even if one thinks a little more unconventionally, was shown by various bags made from the life jackets of airplanes.





There was also a little model railway to see: At the **Trainini®** booth the children's diorama "Auf der schwäb'schen Eisenbahn" was shown, which is presented in the current Märklin magazine (photo above). Frank Meisen showed excellent aeroplane dioramas in 1:500 and 1:200 scale (photo below) according to civil and military models.

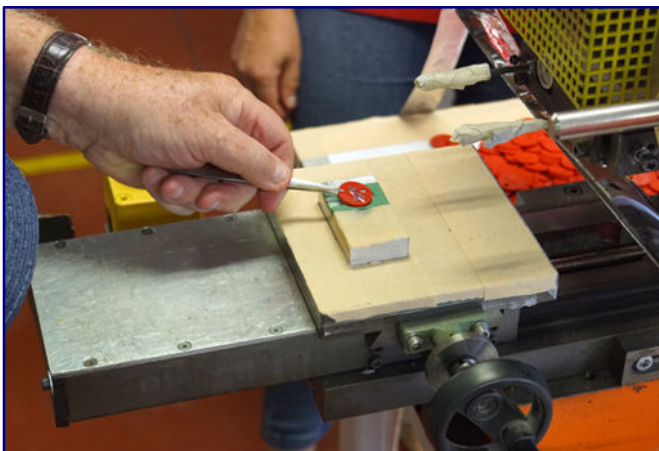
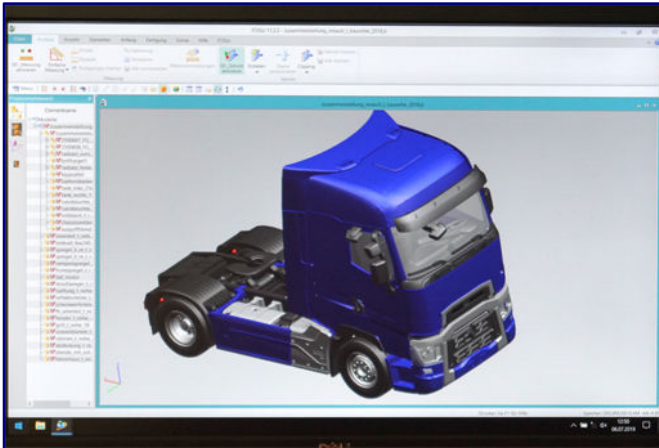

## A brief look at Herpa's production:

We skip the injection moulding and the assembly, because we had already shown them using Märklin as an example a few years ago, and look at the construction screens (top right photo). Every model today has its origin on the computer that replaced the drawing board many years ago. Shiny chrome parts and window frames don't get their colour from varnishing or printing, but from foil embossing. There are a number of colour ribbons of different shades to choose from (top right photo).

Foil embossing on the injection moulded blank takes place at a temperature of 250°C. The finished part is then removed with tweezers (bottom left photo). Finally, we show some injection moulded raw parts, embossed with chrome foil and a finished car model that has completed all production steps (bottom right photo).

And it is precisely these "weird" approaches that keep us model builders and railroaders moving forward and discovering new ways! If you want to be there next year, you should, at least, mark 11 July 2020 on your calendar.

### Webpages of the organizer:

<https://www.herpa.de>

### Exhibitors for Z gauge:

<http://www.airport-diorama.de>

<http://www.z-lights.de>

### Bags made of life jackets:

<https://www.bag-to-life.com>

# Eisenbahnmuseum Dieringhausen



## Einzigartig in Europa

*Spur Z Ausstellung  
im historischen Güterwagen  
im Eisenbahnmuseum Dieringhausen*

*Die Sonntags-Ausstellungstermine:*

*08.06.2019, 09.06.2019, 16.06.2019, 07.07.2019,  
28.07.2019, 11.08.2019, 22.09.2019, 13.10.2019,  
27.10.2019*

*jeweils von ca. 10:00 Uhr – ca. 17:00 Uhr*

**Infos unter: [www.stammtisch-untereschbach.de](http://www.stammtisch-untereschbach.de)**

Readers' letters and messages

## Zetties and Trainini in Dialogue

**Thank you for each letter to the editor and all the feedback that reaches us. Write us (contact details are in imprint) - Trainini® lives from dialogue with you! Of course, this also applies to all suppliers in Z gauge, who would like to introduce innovations here. A representative sample is our goal. Likewise, here we note any events or meetings with significance to Z gauge reference, if we are informed in time.**

To the article "Specialists for fine work" (Trainini® 6/2019):

I do not wish to withhold Mr. Theis's answer to my question (...)!

With the same performance of Microgras Pen (81 01 1010) and Pro Gras Micro Applicator (81 01 1001), (...) the Pro Gras Micro Applicator (81 01 1001) with the integrated power supply seems more advantageous for me because working under difficult conditions on a system would be easier and the risk of damage would be reduced:

- no disturbing additional part of the power supply, which would have to be placed on or directly beside the layout
- one cable less above or around the construction site
- easier working possibilities near buildings or in already partially completed landscapes.

Now all I have to do is watch how I manage to get this device with reasonable effort ...

Jochen Brüggemann, per E-Mail

Editor's note: In order not to rip our reader's input out of context and make it more difficult to understand, we also give the decisive feedback from Microrama in the exact wording: "The Pro Gras Micro Applicator (81 01 1001) has a 9-volt block battery as its energy source. The two grassing devices (81 01 1010 and 81 01 1001) have the same power. The battery is housed in the applicator arm".

**We received the following reader's request:**

First of all many thanks for the always very interesting free magazine, which is much anticipated by me every month.

Right now I'm hanging something in the air. The speed controller from Jörger that I used earlier is no longer produced and the FR-1 from Passmann is also no longer available.

So how can I let the new bell armature motors run nice and slowly? In my opinion, there is currently only the hot grinder SFR-1500 on the market for this purpose. But I don't want to buy it before the electronic controller kit from Noch (88163) is on the market. According to Noch, it should be available from September.

(...)



I'm sure you can imagine my request now. I would be very happy about a detailed test in one of the next issues of Trainini. A comparison with the Heisswolf SFR-1500 would also be nice.

Bernd Severloh, Flensburg

Editorial response: We have already directly replied to our reader, and, hopefully, been able to help him. It's true that both controllers mentioned are no longer available from System Jörger and Passmann. However, we will not be able to carry out the desired comparative test, as there is no access to at least one of the devices or to a suitable measuring tool to display and evaluate the transmitted current pulses.

Since our reader's expectations are based on the operation of bell armature motors that do not require pulse width modulation (PWM) and could even suffer damage (shortened service life), we have recommended the Heisswolf products, which allow locomotive-specific and storable settings. As far as quality is concerned, we rely on Bernd Heisswolf's acknowledged good reputation and third-party test reports.

#### **Error correction on one's own account:**

On page 57 of the July issue of Archistories' Kallental fire station (for the 1zu220 shop) the copyright notice for the product photo was missing. As many readers may have noticed, this photo was also taken by the manufacturer himself, which we would like to pass on for your information.

In the report about the DB-Museum Nürnberg we made a mistake which could be corrected in the English edition (International Edition): On page 51 we have written in connection with the role of the railway in the industrialisation of the late 20th century. Of course, it must read correctly 19th century!

#### **An autumn novelty blabbers away?**

In the current issue of "Züge" (issue 4/2019) you can read that the Märklin 101 064-4 advertising locomotive, which we presented in the prototype, will be available in H0 and Z gauges for the 160th anniversary of the company. While it has already been announced on a larger scale, the Zetties were waiting for the appropriate information.



Since Klaus Eckert, who is present at the application of the films in Dortmund, is responsible for "Märklin-TV" as well as "Züge", and is, therefore, close to the Göppingen manufacturer, this announcement should be valid, as long as it was not a printing error.

Since such an anniversary model should sell well, especially for the core brand, and since the 101 series has only recently received a product update, we do not want to assume that it is an error.

#### **Autumn new products for Nothaft:**

Andreas Nothaft (<https://www.modellbahndecals.de>) and his drawing team were also busy again and created many new lettering sets over the summer. Two of them, which should also be interesting for the scale 1:220 and will be scaled accordingly on request, are presented here.

First of all, there are several new locomotive numbers and coats of arms for SBB Ae 6/6 locomotives, among them the 11469 "Thalwil" (Art.-No. 11469). The EHG (6600) marking sets for pig iron cars are available in six different versions for 12-axle and 16-axle cars. This should also allow Märklin's torpedo ladle cars to be customised on request.

## Fine accessories from Artitec:

The Dutch manufacturer Artitec from Amsterdam has developed into an important supplier of accessories in gauge Z as well. The Zetties are now eagerly awaiting announcements and new deliveries every year.

Shortly after the editorial deadline of the last issue the time had come and the first models for 2019 could be delivered. This is first of all the finished model of an AEG transformer (Art.-No. 322.021) as load for heavy trucks.

The fine model shows many details and sharp engravings, which make it clearly recognizable even from the usual viewing distance. However, special regulations of the prototype were also observed: the three insulators are correctly dismantled and fixed separately on the loading frame for vertical (standing) transport.



The AEG transformer (Art.-No. 322.021; photo above) and the horse with plough (322.023; photo below) are current Artitec new products, which are more than just successful and set standards in this design.

The cleanly painted and very realistic looking model is again made of resin. This also applies to the second new product, which almost took our breath away at the International Toy Fair: Although the horse with plough (322.023) cannot do without small metal attachments, it is so tiny and filigree that the observer instinctively holds his breath, so as not to inadvertently disturb this figure.

Artitec (<https://www.artitec.nl>) has created a unique selling proposition for itself here after selection and implementation quality, which the Zetties hopefully reward with good encouragement. Therefore, we would like to remind you that horse-drawn ploughs were by no means typical only in epochs I and II.

In the context of an article on agricultural machinery on a scale of 1:220, we had explained how the motorisation of agriculture slowly took off after 1945. Until well into the fifties, the cultivation of fields was still characterized by hard work for humans and animals. Due to a lack of sufficient financial resources, small farms in particular switched very late to tractors.

#### **Cross-Scale Schrax New Products:**

Schrax, the 3D printing accessories supplier, has designed a piping system that can be plugged in. Depending on the construction scale and application, it can be equipped with a variety of tasks: District heating pipe, waste water system, chemical plant or also as loaded goods. Therefore the parts with a pipe diameter of 9 mm are not permanently assigned to a single track gauge.



The pipeline system is to be further expanded and expanded. The new pipe sections are loaded here as examples on an H0 model. Photo: Schrax

The offer initially includes straight pipe pieces (68 mm length) and bends with branch angles from 30°, 45° and 90°. An extension of the assortment, among other things around branches and further diameters is planned. The assortment is to be found at <http://www.schrax.com> over following the path: Start page "gauge H0 - 1:87," "small parts," "building site accessories" piping system.

#### **Digital-Infoday in the 1zu220-Shop:**

The 1zu220-Shop (<https://www.1zu220-shop.de>) organizes a digital information day at its headquarters in 34431 Marsberg-Westheim, Kasseler Straße 7, on September 3, 2019.

From 10:00 to 18:00 a Märklin digital trainer will demonstrate the Märklin H0 demonstration system and answer all questions about digital topics. A seminar room on the 2nd floor of the brewery building will be used.

Also for Zetties in attendance is worthwhile itself, because Jörg Erkel and its coworkers will inform also about the digital enterprise in this scale of modelling. They will also show a Z gauge demonstration system with Märklin components (CS3plus control centre, busy detector and switching decoder). Also on display are the "Kallental" and "Schmiedehagen" systems known from several exhibitions, as well as the viaduct diorama.

#### **Confirmed world records:**

The Hamburg Miniatur Wunderland is proud to have confirmed or recognized two world records. With 315 new track meters, they increase their own world record as the largest model railway in the world. For



We continue with the Miwula on the other side of the canal photo: Miniature Wonderland.

the first time, the show layout was explicitly recognised as the largest performance to scale. After all, 1367.21 km converted real length can now be admired in the Speicherstadt (warehouse city, Hamburg).

The congratulations came just in time for the 18th birthday of the "Miwula". We would like to think that it has grown up in the meantime.

But what was told to the press sounds almost crazy and dreamy, but it is true: The show will be extended and will soon also be on the opposite bank with a bridge over the canal.

Since 25 % of them come from abroad, and seem largely the same for many European landscapes and cities, England was dropped as a new model and replaced by South America with Rio de Janeiro, Patagonia and the rainforest.

3,000 m<sup>2</sup> of new space is to be developed here. It is planned to invest around 10 million euros there and to open up a "new world" for visitors.

Central America, the Caribbean and Asia are to follow by the end of 2026. The first part is already under construction and is scheduled to open at the end of 2021. It is to cover 200 to 220 m<sup>2</sup> and will be built on site, as the work on it is already being carried out together with a model railway enthusiast family in Argentina.

#### News about Märklin deliveries:

Now Märklin's current edition of the Swiss crocodile Ce 6/8III (Art.-No. 88564) seems to have been delivered completely. The green "reptile" for the 100th anniversary of this locomotive type was reproduced as an operational museum machine with the company number 14305.

In keeping with the times, it rolls forward with an inwardly moved switching screw, bell-shaped armature motor, fine printing and lacquering as well as LED lighting, thanks to which the Swiss light change has now also been implemented. Worthy of the occasion is the genuine wooden case used as packaging, including a metal replica of the manufacturer's board and a small brochure on the history of the machine.



Era VI is currently being served by a two-piece wagon pack (Art. No. 82425) to extend the DBG track construction train.



And then, as this summer draws to a close, it's time again for the Märklin Magazine's annual car (80829), for which in 2019 the still young form of the open freight car Omm 52 will have to be delivered in the correct length. The model is painted in the usual magazine blue. Already in the last issue we had with our report the forthcoming delivery of the very successful Fischbauchbrücke (fish belly bridge; 89758), which has now been completed.

For the friends of Era VI there is a supply of the DBG (82425). With the yellow flat and self-discharging wagon, the track construction train for Deutsche Bahn AG, which was launched a few years ago, can be extended even further.

We had to wait a long time for the second car display (87408) with three passenger coaches each from the DB (Bpmz 291), SBB (Eurofima couchette car Bcm) and SNCF (type B9u).

The SNCF models are declassified, former 1st class Eurofima cars. Therefore they still carry the yellow stripe above the windows, but are correctly labeled for the 2nd class. A further distinguishing feature to the cars from the previous pack 87409 is the newer logo of the railway administration.

All models are excellently varnished, finely inscribed, individually packed and without train plates, which allows a generous use on the model railway without style break. Delivery of the revised BR 798 / 998 (88167) rail bus has only just begun. We will hold a short meeting as soon as larger quantities are available and we can evaluate it ourselves.

For the outstanding model of the Kittel steam railcar (88145), Märklin informed the dealers in an information letter that technical problems had been solved, but that the supply of open orders could probably only be continued in the 1<sup>st</sup> quarter of 2020.



The Uerdingen rail bus, which has been significantly upgraded in the context of product upgrades, is now also available as a two-part unit of the 798 / 998 series for Era IV (88167).

Also the Insider model 2017, a V 80 of the DB (88803), is even longer in coming than last communicated. Since there have been rumours recently that this model does not come from Märklin and the construction, tools or even the complete model have only been purchased, we publish here the complete answer of Märklin to our readers in exact wording:

“Unfortunately, we have to inform you that (the articles) 88145 and 88803 are subject to longer delays in delivery. 88803 had a serious tool defect, the elimination of which has a massive impact on our original production planning.

At the present time, taking into account a completely new planning of 88803, it can be assumed that the article will not be available until the third quarter of 2020. We very much regret this new, massive postponement. Unfortunately, this cannot be avoided.

But we assure all our customers that we are working at full speed on the processing of customer orders and will also fulfil them. Also, it is definitely not the case that at the V 80 there is any kind of cooperation with a company that announced this model several years ago.”

**There is no summer break at C-M-K:**

Also the couple Klingenhöfer (<https://www.klingenhoefer.com>) did not give themselves a summer break and has informed us about some new products. And they have it in them again.

Why only stage weddings? For the design of church scenes Creativ-Modellbau Klingenhöfer now also offers a priest at the baptism (Art.-No. ET02). The scope of delivery includes the person baptized, his mother and the clergyman. As premium figures they carry enormously fine paintings, the child was even coloured under the microscope.



Carpenters (art.-no. Z01; photo above left), priests at the baptism (ET02; photo right) and the raccoon on the tree trunk (TW14; photo below left) are only three of the current new products of Klingenhöfer. Photos: C-M-K

A few years later it starts for the father and the child with the handcart (VK01). This duo of figures will certainly attract many spectators. This also applies to the paramedic with a rescue dog (TH01), whose jacket and dog vest are an eye-catcher due to their warning effect.

Indispensable on building sites are the four figures of the carpenters (Z01), who struggle with heavy roof beams in their typical and very well reproduced working costumes. But nobody wants to get acquainted with the ram (TS12). This applies explicitly to the mighty horns of the ram, which also becomes impressive as a tiny figure.

More dainty is the little raccoon on the tree trunk (TW14), which is easily recognizable thanks to its black and white face mask. Its earliest European examples came from America, and have spread rapidly in

some areas, even displacing native species. They also like to plunder garbage cans in search of food. This also allows their use on plants according to European examples.

#### News and current position demonstrations of AZL:

At the National Train Show, the most important model railroad exhibition in the USA, in Salt Lake City, American Z Line announced new models and showed samples of well-known novelties. At first, there was an eleven-piece "California Zephyr" train car package made up of various 1952 passenger coaches from the CB&Q, D&RGW and WP railway companies. In addition, there is a supplementary single train car of the PRR. They should be available in September or October 2019.

They will be complemented by EMD F3 diesel locomotive sets, which will be available separately with C&BQ, D&RGW and WP markings. We had already reported on the announcement of the EMD shunting locomotives SW1000 and SW1500. However, the first samples of the Alco RS3 and RSD-5 locomotives were shown and delivery is scheduled to begin at the end of 2019.



This official image shows the California Zephyr train with matching locomotive in the format of an A and B unit of the EMD F3. Photo: AZL / Ztrack

At about the same time, the depressed centre flat wagon units "Maxi-1 5-unit Well Car" will also be released, which were also shown as the first pre-series samples and were also demonstrated. And so we turn to the current AZL deliveries, which anyone interested can test on their own layout.



This time the focus is on the name "North Coast Limited". Those who have green as their favourite colour will certainly get their money's worth here, because a two-colour finish in that tone characterises the light passenger coaches.



Most of them come from the Northern Pacific, but the railway companies CB&Q and SP&S RY provided selected examples, as is indicated on the respective coach.



There are 4-4-2 sleeping cars (item numbers 73033-1 to -3), viewing cars (73433-1 to -4), dining cars (73533-1 / -2), luggage cars (73633-1 / -2), seating cars (73733-0 to -2) and pulpit cars (73833-1 / -2) available. The matching double units EMD F3 have the article number 62918-1 and -2.

4-4-2 Sleeping Coaches (picture above), Dome Cars (picture center) and Observation Cars (picture below) from the current deliveries. Photo: AZL / Ztrack

The 89-foot flat cars to extend military trains were given new registration numbers. The brown (911020-3S) and yellow units (911010-6S) are each loaded with two M1 tanks from the production of Z-Panzer.

The 40-foot long, covered AAR freight cars now run for the Kansas City Southern and are again available individually (904306-1), as twin (904376-1) and quad combinations (914306-1).

The limited edition AZL range is supplemented by a double pack of M1126 "Stryker" (AZL-ZP-M1126O) light wheeled tanks, which are used by the US Army as infantry transport vehicles. The models developed by Z-Panzer are made of resin and painted olive green. They are offered as limited edition.

You can find more manufacturer photos of the current deliveries under <http://www.americanzline.com>.

#### **Anniversary of the Faszination Modellbau:**

When Faszination Modellbau once again invites visitors to Friedrichshafen from 1 to 3 November 2019, there will be an anniversary to celebrate: this trade fair will be 25 years old in 2019. The venue (Messe Friedrichshafen) will be open daily from 9:00 a.m. onwards. The exhibition closes at 18:00, one hour earlier on Sunday.

Many manufacturers of large and small series will be represented in the South German border triangle, but Z-Freunde International e.V. also wants to raise the flag for our small gauge again. Also the former railway romantic presenter Hagen von Ortloff will participate again as an exhibitor.

If you want to experience the many facets of model making outside of the railway, this year you even have the chance to win tickets. On the occasion of the anniversary, the organiser is launching a photo competition, for which you can find further information at <https://www.faszination-modellbau.de>.

**You can always find something out of the ordinary at Küpper:**

If you are looking for more unusual loads, you will find them at the Küpper couple from Aachen (<https://spur-z-ladegut.de>). The specialists are currently pointing out turbine axles in the colours red (art. no. Z-135), blue (Z-136) and yellow (Z-138).

They are already mounted and tied down on a carrier floor as a transport frame on delivery, as required by the rail regulations for goods that could otherwise slip.

This also applies to the sewer pipe elements, which are transported in a standing position. Here, two joint positions are offered in which either five (Z-160) or four segments (Z-160-2) are loaded.

But also used models and spare parts can be found at Spur Z Ladegut Josephine Küpper at any time to make the best possible use of the one-time postage.



Blue turbine axles (art. no. Z-136; photo above) and sewer pipe elements (Z-160; photo below) are among the currently available cargoes from Aachen. Photo: Spur Z Ladegut J. Küpper.

**New chemical tank car for Velmo:**

The 1zu220-Shop (<https://www.1zu220-shop.de>) offers a new articulated tank car (Art.-No. 98171), which was ordered by Claudius Veit. He is (rightly) very proud to be the first customer to have realised this wagon with Märklin as an advertising wagon.

Similar to the container wagon with Velmo container around four years ago, as the customer he made sure that his model could ride in the train without only being perceived as an object for company advertising.



The new Velmo advertising van (art. no. 98171), produced by Märklin, has no concrete role model, but is nevertheless designed close to the factory. According to the hazardous substance labelling, the chemical tank car transports ferric chloride for etching printed circuit boards. Photo: Velmo

For this reason, warning pictograms can be found on the model, as well as the operating and adjustment instructions for the plant or the UN number 2582 (for iron(III) chloride) including the hazard number (Kemler number) 80:

- 8 – caustic effect
- 0 – no further dangers (placeholder).

It is therefore a chemical tank car for acids, which is filled here with an acid necessary for etching printed circuit boards. Velmo uses this as advertising for its decoder boards. Consequently, the white belly bandage of Märklin's own editions is also missing, which points to forced ventilation - not recommended here because of poison fumes escaping.

As far as printing has permitted, the area of the boiler below the filler neck is also black rubberized in the model to protect it from damage in the event of spilled acid. The frame is also finely printed, the UIC rope hooks are even set off in yellow: Rarely before has an advertising car been designed with such comparable effort.

#### **New building kits for Modellbau Laffont:**

Two new architectural kits are expected to be available at the end of September 2019, and Modellbau Laffont is now announcing that they will be available. The apartment building (art. no. Z2201) based on the southern German model can also be used in almost all other regions of Germany without any substantive changes. Even the omission of shutters and window surrounds gives it a certain uniform character.

Further shape and colour variants are already planned by the manufacturer. The kit of the three-storey town house has fine roof tile engravings and can be used from epoch II onwards. The dimensions are 67 x 44 x 60 mm (L x B x H).

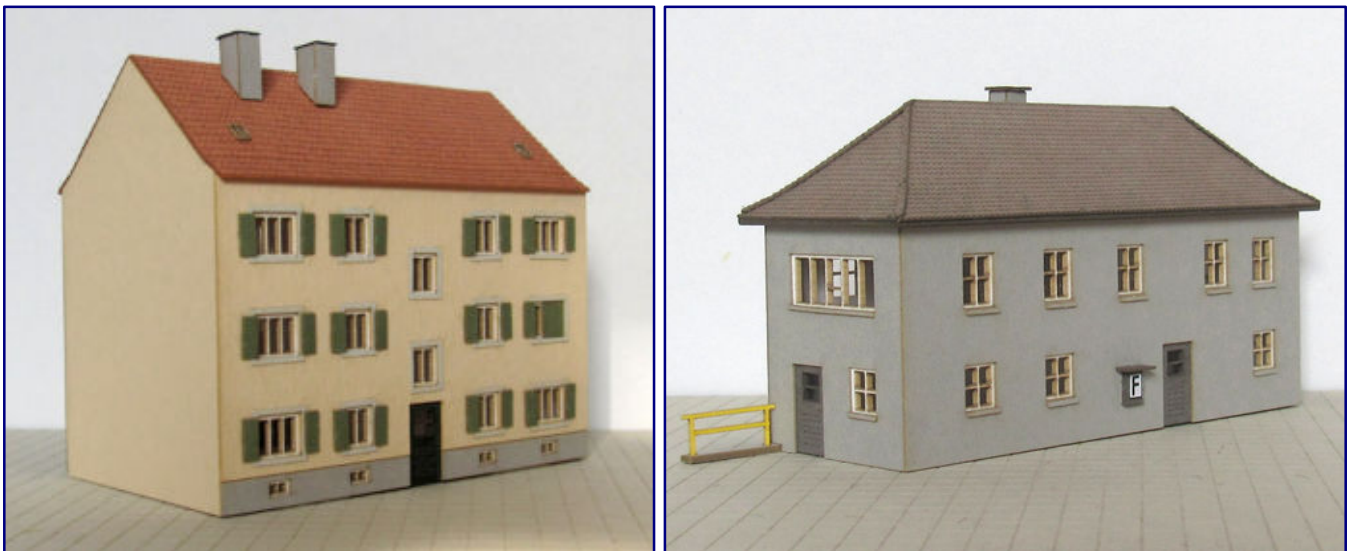

The new multi-family house (art. no. Z2201; picture left) is versatile, while the locomotive line building (Z2301; picture right) will probably only be found in depots. Photos: Modellbau Laffont

This is complemented by a locomotive line building (Z2301) in the form of a grey plastered, railway-typical functional building with a stepped hipped roof. Like the model from the Heilbronn railway station, it has a yellow safety railing right next to the entrance door to prevent accidental access to the access track to the turntable.

With this railway building for the stay and division of the locomotive personnel, the circular engine shed, which was included in the scope of supply of the last edition of the Märklin turntable, can be supplemented according to the prototype.

This kit also shows fine engravings on the roof tiles and can be used as a prototype in epochs II to V. The new model is also available in the Märklin turntable. The basic dimensions in this case are 76 x 28 x 44 mm.

The full manufacturer's program of this manufacturer is at <https://www.modellbau-laffont.de>.

#### No business operations with Full Throttle:

At the US small series manufacturer WDW Full Throttle by William Dean Wright, business operations will be suspended until further notice. The reason is a serious illness that requires a break of an unforeseeable length.

#### Military equipment from Andrew Hart:

Z-Panzer (<http://z-panzer.com>) has focused strongly in recent years on developing military vehicles exclusively for AZL. After a few years, the M548 transport and ammunition tank from the United States is now a new model under AZL's own name.

The original was already developed and put into service in the sixties and was based on the M113 light tank, which was also part of the Z tank range. In Europe, the prototype of the new model was mainly used by the Swiss Army.

The monochrome olive-green miniature is supplied in the usual high level of detail in a limited edition as a resin model.



Transport and ammunition tank M548 by Z-Panzer. Foto: Ztrack

#### And this is new at Micro-Trains:

MTL plans to deliver the EMD SD40-2 with Union-Pacific labels in a camouflage finish (Art.-No. 970 01 300) and with the company number 3593 this month.



Refrigerator car "Dingfelder & Balish" (Art.-No. 518 00 770). Photo: Micro-Trains

From the Farm-to-table series the model number 7 appears with a wooden 40-foot refrigerator car "Ding-felder & Balish" (518 00 770). It is painted brown on the sides and has yellow sidewalls with the advertising banners.

Two black tank cars each appear in parallel for the Union Pacific (530 00 391 / -392) and the Baltimore & Ohio (530 00 061 / -062).

In Germany Micro-Trains products can be purchased at Case-Hobbies (<http://www.case-hobbies.de>).

**Herpa new products for the Christmas business:**

The Dietenhofen model manufacturer has announced its innovations, which are to be available during the Christmas business in November and December 2019. With a few size-related exceptions, they are suitable for illustrations based on European models:

Wideroe De Havilland Canada DHC-7 (Item No. 570565) and Classic Antonov / LTS Air Taxi Service Antonov AN-2 "Anushka" (570602).

Especially worth mentioning is the Douglas DC-3 of Swissair in the so-called neutral colour scheme (570558) with wide, white and red stripes on fuselage and wings. It was used in the first half of the forties. The aim of this coating was to prevent an accidental launch by the warring parties.

Among the military models the current Lockheed Martin C-130J-30 "Super Hercules" of the US Air Force of the 62<sup>nd</sup> Airlift Squadron, 314<sup>th</sup> Airlift Wings of the Little Rock Air Base in design "D-Day Heritage Flight" (570541) plays a special role. 75 years after the Allied air landing, two of these transporters took part in the anniversary celebrations on the French coast.

The model comes with non-functioning airport floodlight masts "360" (570626), two of which are supplied in the package. They show a luminous wreath, the model of which emits light all around. From our point of view, such luminaires are also suitable for larger industrial areas on model railways.

The new products are rounded off by the simplified plastic model of a "Eurowings Airbus A319" (612487) from the Snapfit series in flight position.

**Eisenbahnfreunde Marsberg celebrates 40 Jahre:**

Die Eisenbahnfreunde Marsberg n Westheim/Westphalia celebrates their 40th anniversary on 21 and 22 September 2019. We cordially invite you to do so and would like to receive the following information.

"The Eisenbahnfreunde Marsberg e.V. was founded on 9 June 1979. We are a registered association and since April 2005 we are recognized by the tax office Brilon as a non-profit organization.



In the last years the signal tower got a new beautiful exhibits also in the scale 1:220 are safe for the visitors, if the Eisenbahnfreunde Marsberg e.V. invite to an exhibition day.

in front of it. With the help of our young people, ballast was shovelled from the 3rd track to the former track bed in front of the signal tower.

Our clubhouse is the signal tower Westheim (Westf.) in 34431 Marsberg-Westheim. This signal tower is the last remaining railway building in the Marsberg area. The association has leased the building from DB and is responsible for the maintenance of the building.

In the last years the signal tower had a new roof and new windows installed. On the upper floor there is an exhibition with exhibits and photos showing the history of the railway line. The signal tower is a member of the Hochsauerlandkreis museum landscape.

On 3 September 2002, a railway wagon of the type B3yg was erected



The required rails were provided by a siding from the Messinghausen quarry. The journey across the road from Osnabrück was made possible by the company Freitag. Jörg Erkel's father was allowed to erect the wagon with a small Hartinger crane. Our wagon is now used as a meeting room.

The module layout with the theme "Im Diemeltal", started in 1993, was extended in 2007 by the section "Westheim" on the occasion of the 925th anniversary of the village of Westheim. The theme of the modular railway is the Ruhrtalbahn from Bredelar to Westheim.

Meanwhile, the system has been digitised and given a new automatic staging yard. It is located in the former beverage market in Westheim on Waldecker Straße. Visitors are welcome here on Wednesdays from 6 p.m. The same applies to our two anniversary operating days, which will take place there on 21 and 22 September 2019.

The 33 members of the Eisenbahnfreunde Marsberg are on their way in all gauges, three of them in Z-gauge, by the way."

**Short film about the digital NOHAB by Freudenreich:**

In the May 2019 issue we published our NOHAB test report by Freudenreich Feinwerktechnik and nominated the model for the best new releases of 2019. Since the digital sound functions, in particular, cannot be reproduced in the magazine, we had announced a short film about it.

This was published on our website on August 16, 2019. In the almost 13-minute video sequence, all 21 digital functions, including 16 on sounds, are presented in detail to the solution developed by Velmo, so that our readers can also form their own opinion.

To view the film, please go to our home page (<https://www.trainini.de>) and click on the image representing a film strip. You will then be automatically redirected to the **Trainini® TV** page where you can start the film. Make sure that you have switched on the loudspeaker on your computer.



**The Märklintage in Göppingen:**

The 12th edition of the Märklintage will take place in conjunction with the 36th International Model Railway Exhibition from 13 to 15 September 2019 in Göppingen. The venues for the event are the railway station, the Märklin factory with the Märklineum, the EWS Arena and the Leonhard-Weiss-Areal.

Contrary to what was assumed at the last exhibition two years ago, Stauferpark can also be included. Here, in the shipyard hall and tents, there will be display installations and manufacturer stands. The ZFI will compete for Z gauge, and can be found in an adjoining room of the Leonard-Weiss-Areal. However,

we are expecting further participants, because a Track Z Convention for Southern Germany has been announced again.

But even less than a month before, the organizer has not yet provided any detailed information on the installations and exhibits, official documents unfortunately read like copies of earlier editions without any concrete information content. This makes planning particularly difficult for those who have to make long journeys and therefore want to carefully plan their visits.



Is she coming or isn't she? The Bavarian S 3/6 3673 from the railway museum Nördlingen belongs to the regular guests of the Märklintage. Whether the steam locomotive, which last operated for the Bundesbahn as 18 478, will also be there this time, remained unknown until the editorial deadline. Unfortunately, the same lack of information also affects other models and exhibited installations.

Likewise, it is almost unknown which model locomotives will be arriving and will be seen on site. What is certain, however, is that visitors will be able to take a closer look at the progress of the Märklineum exhibition. If you are fond of a visit, you can keep up to date from the official pages: <https://www.maerklin.de/de/erlebnis/maerklineum/maerklin-tage-2019/>.

---

## Imprint

ISSN 2512-8035

Bibliographic information of the German National Library: The German National Library lists this publication in the German National Bibliography. Detailed bibliographical data and editions can be found in the DNB catalogue at <https://portal.dnb.de>.

The publication of **Trainini Praxismagazin für Spurweite Z** is voluntary and non-commercial. **Trainini German Magazine for Z Gauge** does not aim for any sources of income. This publication is governed exclusively by German law.

Contributions marked by name exclusively reflect the personal opinion of the author. This is not necessarily the same as that of the editor or publisher. Unless otherwise indicated, photos are taken by the editor.

Board of Editors:  
Holger Späing (Editor-in-Chief)  
Dirk Kuhlmann  
Joachim Knight

Correspondent North America:  
Robert J. Kluz

English translation:  
Alexander Hock, Christoph Maier, Martin Stercken

Further voluntary work: Michael Etz (**Trainini Locomotive Doctor**), Stephan Fuchs, Torsten Schubert

Publisher and V.i.S.d.P. is Holger Späing, Am Rondell 119, 44319 Dortmund; Contact: 49 (0)231 9598 7867 or by e-mail to [redaktion\[at\]trainini.de](mailto:redaktion[at]trainini.de).

Advertisements of events and advertisements of third parties are free of charge, but will only be accepted after availability and recognisable track Z reference. They appear separately from the editorial part on the sole responsibility of the advertiser. Advertisements from small series providers always have priority.

Letters to the editor must be submitted in writing by post or e-mail to [leserbriefe\[at\]trainini.de](mailto:leserbriefe[at]trainini.de), stating the full name and address of the responsible reader, and are always welcome. Publication is reserved to the editorial staff. The editorial team always endeavours to present a representative picture and therefore to take every submission into account.

By submitting pictures, photos and drawings, the sender agrees to the publication and indemnifies the publisher against any possible claims by third parties. This expressly includes a future repetition in the magazine, annual video as well as in brochures and posters.

All company names, trademarks and designations mentioned in this publication belong to the respective manufacturers or rights owners. Their reproduction takes place without guarantee of the free usability. For misprints, errors, price quotations, product descriptions, building specifications or transmission errors of any form whatsoever, the editorial staff and publisher assume no liability.

**Trainini Praxismagazin für Spurweite Z** is published monthly (without guarantee) and is available to all interested model railroaders, especially friends of gauge Z, to download free of charge and for a limited time from <http://www.trainini.de>. Downloading may incur third-party connection and network service provider costs. The placement of only the complete magazine on other domains is expressly permitted after removal from one's own pages, as long as the download is not offered for a fee.

All contributions, photos and reports are subject to copyright. Translation, commercial printing and any other form of reproduction, even in part, require the prior express consent of the publisher. Unauthorized commercial use will not be tolerated.

**Trainini®** is a legally protected trademark, registered in the register of the German Patent and Trademark Office (Munich), No. 307 30 512. The trademark is owned by Holger Späing, Dortmund. Misuse will not be tolerated. All rights reserved